



7-INCH AUDIO/VIDEO RECEIVER

iLX-W770

EN

FR

ES



- OWNER'S MANUAL
Please read before using this equipment.
- MODE D'EMPLOI
Veuillez lire avant d'utiliser cet appareil.

- MANUAL DE OPERACIÓN
Léalo antes de utilizar este equipo.

Thank you for purchasing this Alpine product. Please take a moment to protect your purchase by registering your product now at the following address: www.alpine-usa.com/registration. You will be informed of product and software updates (if applicable), special promotions, news about Alpine.

Merci d'avoir acheté ce produit Alpine. Nous vous invitons à consacrer un moment à la protection de votre achat en enregistrant votre produit dès maintenant à l'adresse suivante : www.alpine-usa.com/registration. Vous serez tenu informé des mises à jour des produits et des logiciels (le cas échéant), des promotions spéciales et de l'actualité d'Alpine.

Gracias por adquirir este producto Alpine. Con solo unos pocos pasos podrá proteger su producto, registrándolo a través de la siguiente dirección: www.alpine-usa.com/registration. Recibirá información sobre nuevos productos y software, promociones especiales y novedades sobre Alpine.

Contents

Operating Instructions

PRECAUTIONS

IMPORTANT INFORMATION	5
-----------------------------	---

WARNING

Points to Observe for Safe Usage.....	5
WARNING	5
CAUTION	6
NOTICE	7

Getting Started

Location of Controls	9
Turning Power On or Off.....	9
Turning the System On	9
Adjusting the Volume.....	9
Lowering Volume Quickly	9
Touch Screen Operation.....	10
About the HOME Screen	10
About the Indicator Display	11

Radio

Radio Basic Operation

Listening to the Radio	12
Presetting Stations Manually	12
Presetting Stations Automatically	12
Mode switching Settings	12

Apple CarPlay (Optional)

Access to wired Apple CarPlay.....	13
Access to wireless Apple CarPlay	13

Android Auto™ (Optional)

What is Android Auto	13
Access to wired Android Auto.....	13
Access to wireless Android Auto.....	13

USB Flash drive (Optional)

Playback.....	15
Fast-forwarding/Fast-reversing (USB Audio/Video).....	15
Repeat Play (USB Audio/Video)	15
Shuffle Play (USB Audio/Video)	15
Searching for a Desired Song/Video/Photo.....	15
Slide Show (USB Photo).....	15
About USB List	15

iPod mode on iPhone (Optional)

Playback.....	16
Searching for a Music File.....	17
Repeat Play.....	17
Shuffle Play.....	17

SiriusXM® Satellite Radio Operation (Optional)

Receiving Channels with the SiriusXM Tuner ...	18
Tuning Channels by Category	18
Checking the Sirius XM Radio ID Number	19
Storing Channel Presets	19
Tuning Channels Using Presets.....	19
SiriusXM List	19
Selecting The Channel Directly.....	19
Parental Lock Function	19

Bluetooth® Operation

Setup Before Using.....	20
About Bluetooth	20
About the Hands-free Phone	20
Before Using Bluetooth.....	20

Hands-free Phone Control

Answering a Call	21
Hanging up the Telephone.....	21
Calling.....	22
Making a phone call using the Phone Menu ...	22
Siri	22
Phone Operation Screen	23
Adjusting the Speech Volume.....	23
Changing the Voice Output	23
DTMF (Touch-Tone) Function	23

Phone Book Function.....	23
Synchronizing the Phone Book.....	23
Bluetooth® Audio	
Playback.....	24
Repeat Play.....	24
Shuffle Play.....	24
AUX Operation (Optional)	
AUX Operation.....	24
Camera Operation (Optional)	
Camera Operation.....	25
Displaying the Camera Image	
from the Menu screen.....	25
About the Rear/Front Camera Guide.....	25
About the Side Camera Guide.....	25
Connection Operation.....	25
Sound Boost and Lighting link (Optional)	
Lighting Link Setting Operation.....	26
Lighting Link settings Colors.....	27
Setup	
Setup Operation.....	28
System Setup	
Language Setup.....	29
Time Adjust Setup.....	29
SiriusXM Setup.....	29
Parental Control.....	29
Clear Locked All.....	30
Changing the Lock Passcode.....	30
Version.....	30
Product Information.....	30
Updating the firmware version.....	30
Software License.....	31
Connection Status.....	31
DEMO MODE.....	31
Reset.....	31
Screen/Lighting Setup	
Dimmer.....	32
Screen Color.....	32
Key Color.....	32

Sound Setup	
Setting the Fader/Balance.....	33
Adjusting the Bass/Middle/Treble.....	33
Adjusting the Graphic Equalizer	
Curve (EQ).....	33
Setting an Equalizer.....	34
Setting the Subwoofer.....	35
Adjusting the Crossover Settings (X-Over).....	35
Adjusting the Time Correction (TCR).....	35
Setting the Speaker Level.....	36
Setting Defeat.....	36
About the Crossover.....	36
About Time Correction.....	37
Example 1. Listening Position:	
Front Left Seat.....	37
Example 2. Listening Position: All Seats.....	37
Volume Setup	
Volume Setup.....	38
Bluetooth Setup	
Device List.....	38
Pairing the Bluetooth Device.....	38
Fast pairing the Bluetooth Device.....	38
Deleting a Bluetooth Device from the list.....	38
Searching for a Bluetooth Device.....	38
Displaying Bluetooth Information.....	39
Auto Connection.....	39
Downloading the Phonebook.....	39
Wi-Fi® Setup	
Device Info.....	39
Rear Camera Setup	
Parking Guide Adjust Setup.....	40
Video Setup.....	40
2nd Camera Setup	
Guide Line Adjust.....	41
Video Setup.....	41
Lighting Link ON/OFF	

Information

About the Supported Formats	44
About Audio Format	44
About Video Format	44
About Photo Format	45
In Case of Difficulty	46
If this Message Appears	47
Specifications	49

Installation and Connections

WARNING	50
CAUTION	50
Precautions	50
Accessory List	51
Installation	51
Caution concerning the installation location.....	51
Mounting the Microphone.....	51
Installation example using the Original Mounting Bracket.....	51
Connections.....	52
If an ACC power supply is not available.....	54
System Example.....	55

LIMITED WARRANTY

Operating Instructions

PRECAUTIONS

IMPORTANT INFORMATION

FCC COMPLIANCE STATEMENT

This equipment has been tested and found to comply with the limits for a Class B digital device, pursuant to part 15 of the FCC Rules. These limits are designed to provide more reasonable protection against harmful interference in a residential installation, and are more stringent than "outdoor" requirements.

Operation is subjected to the following two conditions: (1) This device may not cause harmful interference, and (2) this device must accept any interference received, including interference that may cause undesired operation.

This equipment generates, uses, and can radiate radio frequency energy and, if not installed and used in accordance with the instructions, may cause harmful interference to radio communications. However, there is no guarantee that interference will not occur in a particular installation. If this equipment does cause harmful interference to radio or television reception, which can be determined by turning the equipment off and on, you are encouraged to try to correct the interference by one of the following measures:

- Reorient or relocate the receiving antenna.
- Increase the separation between the equipment and the receiver.
- Connect the equipment into an outlet on a circuit different from that to which the receiver is connected.
- Consult an experienced radio/TV technician.

WARNING

Points to Observe for Safe Usage

- *Read this manual carefully before using this system components. They contain instructions on how to use this product in a safe and effective manner. Alpine cannot be responsible for problems resulting from failure to observe the instructions in this manual.*
- *This manual uses various pictorial displays to show you how to use this product safely and to alert you to potential dangers resulting from improper connections and operation. Following are the meanings of these pictorial displays. It is important to fully understand the meanings of these pictorial displays in order to use this manual and the system properly.*
- *This product may be used with software applications. Please follow all usage instructions and warnings when using this product at all times. Do not use this product or any software application in a manner which will hinder safe operation of your vehicle.*

WARNING

- Operation of the system while driving is dangerous. Users should stop vehicle before operating the software.
- Road conditions and regulations take precedence over information contained on the map display: observe actual traffic restrictions and circumstances while driving.
- This software is designed for use exclusively in the unit. It cannot and may not be used in conjunction with other hardware.

WARNING

This symbol means important instructions. Failure to heed them can result in serious injury or death.

INSTALL THE PRODUCT CORRECTLY SO THAT THE DRIVER CANNOT WATCH TV/VIDEO UNLESS THE VEHICLE IS STOPPED AND THE PARKING BRAKE IS APPLIED.

It is dangerous for the driver to watch TV/Video while driving a vehicle. Installing this product incorrectly enables the driver to watch TV/Video while driving. This may cause a distraction, preventing the driver from looking ahead, thus causing an accident. The driver or other people could be severely injured.

DO NOT WATCH VIDEO WHILE DRIVING.

Watching the video may distract the driver from looking ahead of the vehicle and cause an accident

DO NOT OPERATE ANY FUNCTION THAT TAKES YOUR ATTENTION AWAY FROM SAFELY DRIVING YOUR VEHICLE.

Any function that requires your prolonged attention should only be performed after coming to a complete stop. Always stop the vehicle in a safe location before performing these functions. Failure to do so may result in an accident.

KEEP THE VOLUME AT A LEVEL WHERE YOU CAN STILL HEAR OUTSIDE NOISES WHILE DRIVING.

Excessive volume levels that obscure sounds such as emergency vehicle sirens or road warning signals (train crossings, etc.) can be dangerous and may result in an accident. LISTENING AT LOUD VOLUME LEVELS IN A CAR MAY ALSO CAUSE HEARING DAMAGE.

MINIMIZE DISPLAY VIEWING WHILE DRIVING.

Viewing the display may distract the driver from looking ahead of the vehicle and cause an accident.

DO NOT DISASSEMBLE OR ALTER.

Doing so may result in an accident, fire or electric shock.

USE ONLY IN CARS WITH A 12 VOLT NEGATIVE GROUND.

(Check with your dealer if you are not sure.) Failure to do so may result in fire, etc.

KEEP SMALL OBJECTS SUCH AS SCREWS OUT OF THE REACH OF CHILDREN.

Swallowing them may result in serious injury. If swallowed, consult a physician immediately.

USE THE CORRECT AMPERE RATING WHEN REPLACING FUSES.

Failure to do so may result in fire or electric shock.

DO NOT BLOCK VENTS OR RADIATOR PANELS.

Doing so may cause heat to build up inside and may result in fire.

USE THIS PRODUCT FOR MOBILE 12V APPLICATIONS.

Use for other than its designed application may result in fire, electric shock or other injury.

MAKE THE CORRECT CONNECTIONS.

Failure to make the proper connections may result in fire or product damage.

BEFORE WIRING, DISCONNECT THE CABLE FROM THE NEGATIVE BATTERY TERMINAL.

Failure to do so may result in electric shock or injury due to electrical shorts.

DO NOT ALLOW CABLES TO BECOME ENTANGLED IN SURROUNDING OBJECTS.

Arrange wiring and cables in compliance with the manual to prevent obstructions when driving. Cables or wiring that obstruct or hang up on places such as the steering wheel, gear lever, brake pedals, etc. can be extremely hazardous.

DO NOT SPLICE INTO ELECTRICAL CABLES.

Never cut away cable insulation to supply power to other equipment. Doing so will exceed the current carrying capacity of the wire and result in fire or electric shock.

DO NOT DAMAGE PIPE OR WIRING WHEN DRILLING HOLES.

When drilling holes in the chassis for installation, take precautions so as not to contact, damage or obstruct pipes, fuel lines, tanks or electrical wiring. Failure to take such precautions may result in fire.

DO NOT USE BOLTS OR NUTS IN THE BRAKE OR STEERING SYSTEMS TO MAKE GROUND CONNECTIONS.

Bolts or nuts used for the brake or steering systems (or any other safety-related system), or tanks should NEVER be used for installations or ground connections. Using such parts could disable control of the vehicle and cause fire etc.

DO NOT INSTALL IN LOCATIONS WHICH MIGHT HINDER VEHICLE OPERATION, SUCH AS THE STEERING WHEEL OR GEARSHIFT.

Doing so may obstruct forward vision or hamper movement etc. and results in serious accident.

**CAUTION**

This symbol means important instructions. Failure to heed them can result in injury or material property damage.

HALT USE IMMEDIATELY IF A PROBLEM APPEARS.

Failure to do so may cause personal injury or damage to the product. Return it to your authorized Alpine dealer or the nearest Alpine Service Center for repairing.

HAVE THE WIRING AND INSTALLATION DONE BY EXPERTS.

The wiring and installation of this unit requires special technical skill and experience. To ensure safety, always contact the dealer where you purchased this product to have the work done.

USE SPECIFIED ACCESSORY PARTS AND INSTALL THEM SECURELY.

Be sure to use only the specified accessory parts. Use of other than designated parts may damage this unit internally or may not securely install the unit in place. This may cause parts to become loose resulting in hazards or product failure.

ARRANGE THE WIRING SO IT IS NOT CRIMPED OR PINCHED BY A SHARP METAL EDGE.

Route the cables and wiring away from moving parts (like the seat rails) or sharp or pointed edges. This will prevent crimping and damage to the wiring. If wiring passes through a hole in metal, use a rubber grommet to prevent the wire's insulation from being cut by the metal edge of the hole.

DO NOT INSTALL IN LOCATIONS WITH HIGH MOISTURE OR DUST.

Avoid installing the unit in locations with high incidence of moisture or dust. Moisture or dust that penetrates into this unit may result in product failure.

NOTICE

Product Cleaning

Use a soft dry cloth for periodic cleaning of the product. For more severe stains, please dampen the cloth with water only. Anything else has the chance of dissolving the paint or damaging the plastic.

Temperature

Be sure the temperature inside the vehicle is between +45°C (+113°F) and 0°C (+32°F) before turning your unit on.

Maintenance

If you have problems, do not attempt to repair the unit yourself. Return it to your Alpine dealer or the nearest Alpine Service Station for servicing.

Protecting the USB connector

- Only an iPhone or USB flash drive can be connected to the USB connector on this unit. Correct performance using other USB products cannot be guaranteed.
- If the USB connector is used, be sure to use only the supplied connector cable with the unit. A USB hub is not supported.
- Depending on the connected USB flash drive, the unit may not function or some functions may not be performed.
- The audio file format that can be played on the unit is MP3/WMA/WAVE/AAC/FLAC/Ogg/APE.
- Artist/song name, etc., can be displayed. Certain, special characters may not be correctly displayed.

CAUTION

Alpine accepts no responsibility for lost data, etc., even if data, etc., is lost while using this product.

On Handling USB Flash drive

- This unit can control a memory storage device that supports the USB Mass Storage Class (MSC) protocol. Playable audio file formats are MP3, WMA, AAC, WAVE, APE, OGG and FLAC.
- USB Flash drive function is not guaranteed. Use a USB flash drive according to the terms of agreement. Read the USB flash drive Owner's Manual thoroughly.
- Avoid usage or storage in the following locations:
 - Anywhere in the car exposed to direct sunlight or high temperatures.
 - Anywhere the possibility of high humidity or corrosive substances are present.
- Fix the USB flash drive in a location where driver operation will not be hindered.
- USB Flash drive may not function correctly at high or low temperature.
- Use only certified USB flash drive. Note that even certified USB flash drive, may not function correctly depending on its type or state.
- Depending on the settings of the USB flash drive type, memory state or encoding software, the unit may not play back or display properly.
- USB Flash drive may take time to start playback. If there is a particular file other than audio in the USB flash drive, it may take considerable time before the file is played back or searched.
- The unit can play back "mp2", "mpa", "mp3", "m4a", "wma", "m4a", "flac"/"fla", "wav", "ogg", "ape" file extensions.
- Do not add the above extensions to a file other than audio data. This non-audio data will not be recognized. The resulting playback may contain noise that can damage speakers and/or amplifiers.
- It is recommended to back up important data on a personal computer.
- Do not remove the USB device while playback is in progress. Change SOURCE to something other than USB, then remove the USB device to prevent possible damage to its memory.

- *Windows Media and the Windows logo are trademarks, or registered trademarks of Microsoft Corporation in the United States and/or other countries.*
- *Apple, iPhone, iPod, iPod nano, iPod touch, iPad, Lightning and Siri are trademarks of Apple Inc., registered in the U.S. and other countries. Apple CarPlay is a trademark of Apple Inc.*
- *Use of the Made for Apple and Works with Apple badges means that an accessory has been designed to connect specifically to the Apple product(s) identified in the Made for Apple badge and to work specifically with the technology identified in the Works with Apple badge, and has been certified by the developer to meet Apple performance standards. Apple is not responsible for the operation of this device or its compliance with safety and regulatory standards.*
- *Please note that the use of this accessory with an Apple product may affect wireless performance.*
- *Use of the Apple CarPlay logo means that a vehicle user interface meets Apple performance standards. Apple is not responsible for the operation of this vehicle or its compliance with safety and regulatory standards. Please note that the use of this product with iPhone may affect wireless performance.*
- *SiriusXM and all related marks and logos are trademarks of Sirius XM Radio Inc. All rights reserved.*
- *Google, Android, Google Play and Android Auto are trademarks of Google LLC. To use Android Auto on your car display, you'll need an Android Auto compatible vehicle or aftermarket stereo, an Android phone running Android 6.0 or higher, and the Android Auto app.*
- *The Bluetooth® word mark and logos are registered trademarks owned by the Bluetooth SIG, Inc. and any use of such marks by Alpine Electronics, Inc. is under license.*
- *MPEG Layer-3 audio coding technology licensed from Fraunhofer IIS and Thomson. Supply of this product only conveys a license for private, non-commercial use and does not convey a license nor imply any right to use this product in any commercial (i.e. revenue-generation) real time broadcasting (terrestrial, satellite, cable and/or any other media), broadcasting/streaming via internet, intranets and/or other networks or in other electronic content distribution systems, such as pay-audio or audio-on-demand applications. An independent license for such use is required. For details, please visit <http://www.mp3licensing.com>*
- *The Wi-Fi CERTIFIED™ Logo is a registered trademark of Wi-Fi Alliance®*

Getting Started

Location of Controls

When system is powered off, Short/long touch any button to turn the power on.

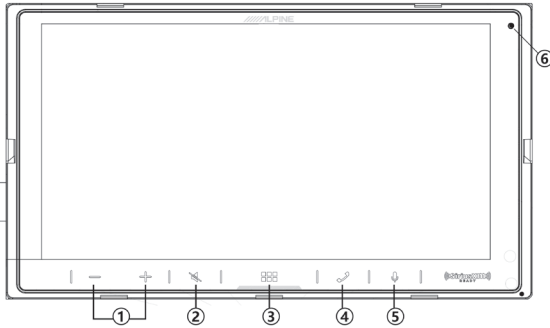

- ① **- / + (DOWN/UP) button**
Touch to adjust the volume.
Touch and hold this button for at least 1.7 second to adjust the volume to maximum or minimum
- ② **🔇 (MUTE) button**
 - Touch to activate/deactivate the mute mode.
 - Touch and hold this button for at least 1.7 second to display on/off
- ③ **🏠 (HOME)/(Power Off) button**
Activates the HOME screen.
Touch and hold this button for at least 1.7 second to turn the power off.
- ④ **📞 (Phone) button**
Activates the Phone screen.
- ⑤ **🗣️ button**
 - When phone is connected to CarPlay, touch this button to activate Siri
 - When phone is connected to Android Auto, touch this button to activate VR
 - When Siri is activated, the function of Siri is available
 - When VR is activated, the VR setting is ON and the function of VR is available
 - When the CarPlay/Android Audio is disconnected, the operation in this button is invalidate
 - When CarPlay/Android Audio is disconnected, touch and long hold to enter into the Device Searching List to activate the new device searching
- ⑥ **(Reset) button**
Reset & Restart.

About the button descriptions used in this Owner's Manual

The buttons found on the face of the unit are expressed in bold (e.g. 🏠 (HOME)). The buttons found on the touch-screen display are shown in bold within brackets, [] (e.g. [X]).

Turning Power On or Off

Some of this unit's functions cannot be performed while the vehicle is in motion. Be sure to stop your vehicle in a safe location and apply the parking brake, before attempting these operations.

- 1 **Turn the ignition key to the ACC or ON position.**
The system turns on.
 - When turned on, the system displays the last screen that was displayed before the ignition key was turned off. For example, if the unit is in radio mode when ignition is turned off, it will remain in radio mode when ignition is turned back on.
- 2 **Touch and hold the 🏠 (HOME)/(Power Off) button for at least 1.7 second to turn the power off.**
 - When the system is used for the first time, the language selection menu is displayed. Select the desired language, and then touch [OK].
 - The unit can be turned on by touching the [🏠] (HOME) button, [-] button [+] button [🗣️] button or [📞] (Phone) button.
 - The unit is a precision device. Careful handling of the unit should provide you with years of trouble-free operation.

Turning the System On

When the system is used for the first time, the language selection menu is displayed.

Select a language, and then touch [OK].

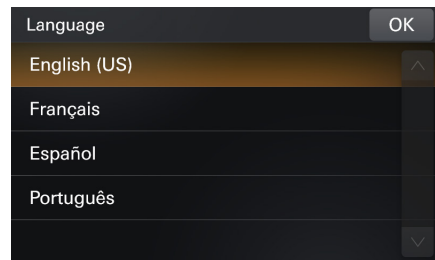

- Some of this unit's functions cannot be performed while the vehicle is in motion. Be sure to stop your vehicle in a safe location and apply the parking brake before attempting these operations.

Adjusting the Volume

Adjust the volume by touching - / +

Volume decreases increases continuously by touching and holding

- / +

Volume: 0 - 35

Lowering Volume Quickly

Audio Mute function instantly lowers the volume level to 0.

- 1 **Touch the 🔇 (MUTE) button to activate the MUTE mode.**
The audio level will be 0.
- 2 **Touching the 🔇 (MUTE) button again will bring the audio back to its previous level.**

Touch Screen Operation

You can operate the system by using the touch panel on the screen.

- Be sure to touch the onscreen button lightly with the pad of your finger to avoid scratching the display.

Touch a button or list item on the screen lightly.

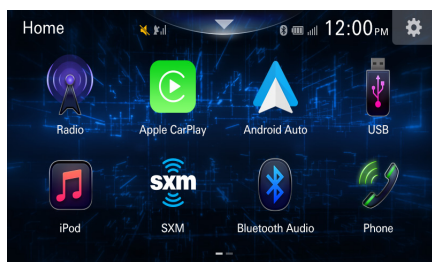

About the HOME Screen

In the HOME screen, you can select the audio source and perform various setups or operations on the unit.

Touch the  (HOME) button.

The HOME screen is displayed.

HOME screen example (Page1)

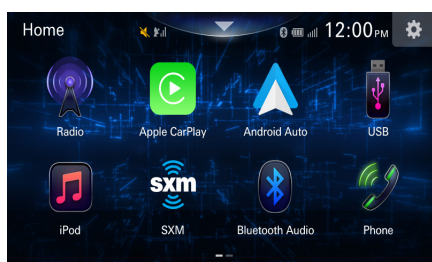

HOME screen example (Page2)



Radio	Displays the Radio main screen (page 12).
Apple CarPlay	You can use Apple CarPlay (page 13).
Android Auto	You can use Android Auto (page 13).
USB	You can play back music files, video files and photo files stored in a USB flash drive (page 14). <ul style="list-style-type: none"> • If a USB flash drive is not connected, this widget is not available.
iPod	Displays the iPod main screen (page 16) <ul style="list-style-type: none"> • If an iPhone is not connected, this widget is not available.
SiriusXM	Displays the SiriusXM main screen (page 18). <ul style="list-style-type: none"> • If a SiriusXM Tuner (Optional) is not connected, this widget is not available.
Bluetooth Audio	Displays the Bluetooth Audio main screen (page 23).
Phone	Displays the Phone main screen (page 23).
AUX	Displays the AUX main screen (page 24).
Camera	Displays the Camera main screen (page 25).
Connection	Displays the status of the connected devices (page 25).

About the Indicator Display

The Indicator Bar at the top of the screen displays various types of information, like the current time.

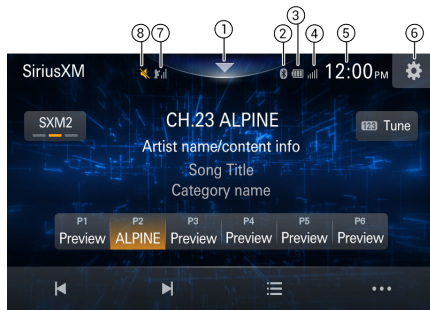

- ① Sound Home Screen.
You can turn the Sound Boost (page 26).
- ② Lights up when connected to a Bluetooth compatible device.
 - Grayed out when Bluetooth is disconnected
- ③ Indicates the battery level of the connected Bluetooth device.

Battery Level	Level 3	Level 2	Level 1	No Battery
Icon				

This may not be displayed depending on the connected Bluetooth device.

- ④ Indicates the signal strength level of the connected Bluetooth compatible device.
Displayed when Bluetooth setting is ON.

0	1	2	3	4	5

- ⑤ Indicates the current time.
You can switch between the 12 hour display and 24 hour display options (page 29).
- ⑥ Setup
Click to enter the Settings
- ⑦ Display SiriusXM signal level

0	1	2	3

- ⑧ Indicates the volume on/off status.

Radio

Radio main screen example

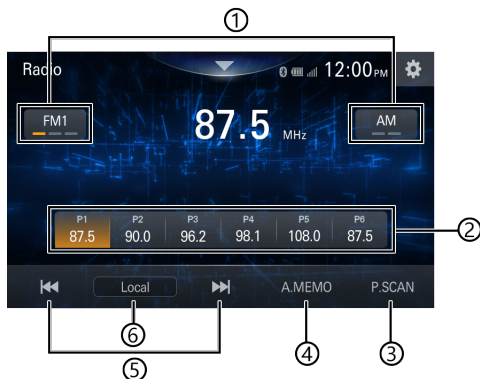

- ① Band button
Switches a band.
- ② Preset button
Displays the preset stations with a short touch.
Touch for at least 1.5. second to memorise the current station as a preset station.
- ③ Plays each preset station for about 10 seconds.
- ④ Scan and memorises active stations automatically
- ⑤ Touch [▶▶▶] [◀◀◀] to select the station seek up or seek down respectively
Touch [◀] [▶] to change the radio frequency up or down respectively.
Operate in manual mode
- ⑥ Switch Local mode/Manual mode/DX mode

Seek up [▶▶▶]

Seek up: From the current station ,seek forward according to the specified step unit ,
After selecting a active station, then play If no active station, will keep searching

Seek down [◀◀◀]

Seek down: From the current station ,seek down according to the specified step unit ,
After selecting a active station, then play If no active station, will keep searching

Radio Basic Operation

Listening to the Radio

- 1 Touch the (HOME) button and select radio mode.
The display shows the radio mode screen.
- 2 Select the desired band from [FM1] / [FM2] / [FM3] / [AM1]/[AM2].
- 3 Touch [▶▶▶], [◀◀◀] [◀], [▶] to adjust the radio frequency.

Presetting Stations Manually

- 1 Tune in a desired radio station you wish to store in the preset memory by manual or automatic seek tuning.
 - 2 Touch and hold the Preset number you want to store for at least 1.5 second.
The selected station is stored.
 - 3 Repeat the procedure to store up to 5 other stations onto the same band.
To use this procedure for other bands, simply select the desired band and repeat the procedure.
A total of 30 stations can be stored in the preset memory (6 stations for each band; FM1, FM2, FM3, or AM1, AM2).
- If a preset memory has already been set in the same preset number, it will be cleared and the new station will be memorized.

Presetting Stations Automatically

From the start Frequency ,scan upon the step unit (+1) and store the validated station ,After one cycle, store the station from low frequency to high frequency

Touch [A.MEMO] go to Scan for stations and store valid stations

- If a valid station is scanned, it is not required to play, the screen display "scanning" during the scanning process and will automatically switch to the first stored station on FM1

Mode switching Settings

Setting item:

Manual/DX(Initial setting)/Local

Setting contents:

Manual mode:manually scanning station

DX mode: When select the DX mode and start to search ,it will be performed until the next or previous valid station, if no valid station is searched, the search continues

Local mode: When select the local mode and start to search ,it will be performed until the next or previous valid station, if no valid station is searched, the search continues



- :By default, Dx mode is used. The Local mode stop sensitivity is increased by 30db over Dx under AM and FM

Apple CarPlay (Optional)

Apple CarPlay is a smarter, safer way to use your iPhone in the car. Apple CarPlay takes the things you want to do with your iPhone while driving and puts them right on the unit. You can get directions, make calls, send and receive messages, and listen to music, all in a way that allows you to stay focused on the road. Just plug in your iPhone to the unit and go.

- *Some functions may not be available while driving.*
- *About iPhone models usable with this unit, see “iPod mode on iPhone (Optional)” (page 16). Only an iPhone 6 or later compatible with Apple CarPlay function.*

Access to wired Apple CarPlay

- 1 Plug in your iPhone using Lightning to USB Cable (Supplied with iPhone) to the unit.**
- 2 Touch the  (HOME) button.**
The HOME screen is displayed.
- 3 Touch [Apple CarPlay].**
The Apple CarPlay screen is displayed.
Touch the desired App icon on the unit, or use Siri function by touching the  button.

Access to wireless Apple CarPlay

- 1 Touch [Connection] button**
The selection iPhone screen is displayed.
Select the iPhone you want to connect and it will goto CarPlay screen after you select.
- *When a used iPhone 6 or later is reconnected, touch the pop-up message-“Apple CarPlay connected.” within 5 seconds to access to Apple CarPlay screen.*
 - *The App must be Apple CarPlay compatible in order to appear in the Home screen.*

Android Auto™ (Optional)

What is Android Auto

Android Auto is designed to make it easier to use apps from your phone while you're on the road. Navigate with Google Maps, listen to Playlists or Podcasts from your favorite apps, and more.

- *Download the Android Auto App from the Google Play Store before continuing.*

Access to wired Android Auto

Just plug in your smartphone to the unit's USB connector, then follow the prompt to pair your smartphone with the unit.

- *The connected smartphone with Android Auto will disconnect other phone's Bluetooth connection and pair to the unit.*

- 1 Touch the  (HOME) button.**
The HOME screen is displayed.
- 2 Touch [Android Auto].**
The Android Auto screen is displayed.

Access to wireless Android Auto

- 1 Touch [Connection] button**
The selection smartphone screen is displayed.
Select the phone you want to connect and it will goto Android Auto screen after you select.
- *You can make a call, use voice recognition function and Android Auto's compatible navigation app, etc.,*
 - *Only Google approved apps with necessary driver-safety measures in place can be used.*

USB Flash drive (Optional)

You can play back music files (WAVE,WMA,AAC,MP3,OGG,FLAC,APE), video files (AVI,MPEG 1/2,MPEG4,WMV,Flash,QuickTime,ASF, Matroska Video,TS Stream,3GP) and photo files (JPG,JPEG,PNG,BMP) stored in a USB flash drive on the internal player of this system.

⚠ WARNING

It is dangerous for the driver to watch video while driving the vehicle. The driver may be distracted from looking ahead and an accident could occur.

Install the unit correctly so that the driver cannot watch a video unless the car is stopped and the parking brake is applied.

If the unit is not installed correctly, the driver will be able to watch a video while driving and may be distracted from looking ahead and cause an accident. The driver or other people could be severely injured.

■ USB Audio mode screen



■ USB Video mode screen

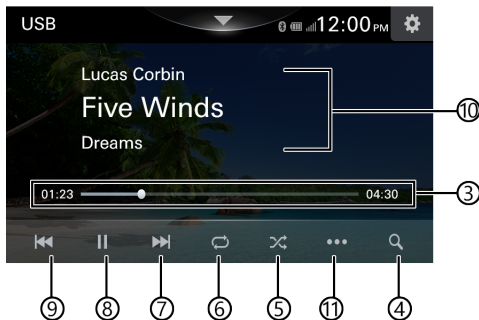

■ USB Photo mode screen

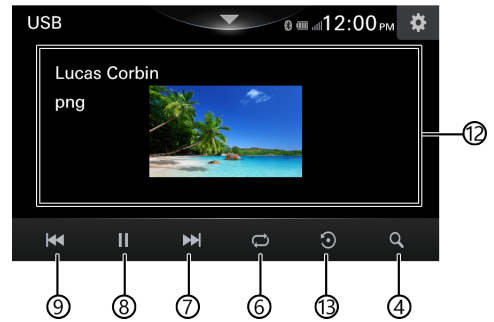

- ① Artwork display
- ② Information display
- ③ Elapsed time/Total time for playing
- ④ Displays the USB List screen
- ⑤ Shuffle mode
- ⑥ [🔄] repeat_off, [🔄] repeat_folder, [🔄] repeat_one, [🔄] repeat_all,
- ⑦ Finds the beginning of next chapter//Fast-forwards when touched for at least 2 second
- ⑧ Pause and Play
- ⑨ Finds the beginning of the current file/Finds a previous file within 3 second after playback starts/Fast-reverses when touched for at least 2 second
- ⑩ Video information display
- ⑪ Video Setup display
- ⑫ Photo information display
- ⑬ Rotate mode

• For your safety, video is not displayed and only audio can be heard while driving.

Playback

- 1 Touch the (HOME) button and select USB mode.
The display shows the USB mode screen.
- 2 Touch [Q] (Search).
- 3 Select the desired mode.
 : USB Audio mode
 : USB Video mode
 : USB Photo mode
- 4 Touch [] or [] to select the desired track(file).

Returning to the beginning of the previous track (file):

Touch [].

Fast reverse the current track :

Touch and hold 2s [].

Advancing to the beginning of the next track (file) :

Touch [].

Fast forward the current track :

Touch and hold 2s [].

- 3 To pause playback, touch [].

Touching [] again will resume playback.

- The playback time may not be correctly displayed when a VBR (Variable Bit Rate) recorded file is played back.
- If there is tag information, artist name/album name/track name is displayed.
- If there is no label information, no name is displayed.
- ID3 tag/WMA tag

If an MP3/WMA/AAC/FLAC/WAVE/Ogg/APE file contains ID3 tag/WMA tag information, the ID3 tag/WMA tag information is displayed. (e.g., song name, artist name, and album name)

Fast-forwarding/Fast-reversing (USB Audio/Video)

During playback, touch and hold [] (Fast-reverse) or touch and hold [] (Fast-forward).

Touch and hold for more than 2 second to fast-forward/fast-reverse.

- **Fast-reverse Speed:**
touch [] to change the speed, x4 → x10 → x32 → off
- **Fast-forward Speed:**
touch [] to change the speed, x4 → x10 → x32 → off

Repeat Play (USB Audio/Video)

- 1 Touch [].
 - The [] button displays the currently selected mode.

- 2 Select your desired Repeat mode.

ALL : All files are repeatedly played back.

One : Only the file currently playing is repeatedly played back.

Folder : Only files in a folder are repeatedly played back.

OFF : Repeat mode is Off.

Shuffle Play (USB Audio/Video)

- 1 Touch [].
 - The [] button displays the currently selected mode.
- 2 Shuffle mode is only valid in [] [].
- 3 When in touch [], automatically switch [].

Searching for a Desired Song/Video/Photo

- 1 Touch [Q] (Search).
- 2 Select the desired mode.
 : USB Audio mode
 : USB Video mode
 : USB Photo mode
- 3 Touch [] or [] to select the folder.
- 4 Touch your desired File name.

When you select a Folder name, repeat the same procedure to select another Folder name or File name.

Slide Show (USB Photo)

The Slide Show shows photos that change every 5 seconds.

To pause playback, touch []

Touching [] again will resume playback.

About USB List

You can select the desired mode

- Each page displays up to 5 files . if you want to view more than 5 files, swipe down or touch alphabet to search

About order

Display and sort according to the head character

Display in the order of 1 -> 2 -> 3 below.

- 0: Folder :When there are folders ,the folders are displayed ahead of the files
- 1: Number (represented by "#" on the Right Search Bar)
- 2: English Alphabet
- 3: Shorting order of Unicode

Right Search Bar (order of list)

- 1: Number (represented by "#" on the Right Search Bar)
- 2: English Alphabet

- Search only the files with numeric or English alphabetic headers

iPod mode on iPhone (Optional)

Before using this function, plug in your iPhone using a Lightning-USB cable (supplied with iPhone) to the unit,

- This unit does not support video playback from iPhone which connected to this unit via USB Connector.
- Internet or telephone function, etc., of the iPhone is not controllable from the unit, but these functions can be controlled using the iPhone itself.

About iPhone models usable with this unit

- The following devices have been tested and shown to work with this unit. Correct function of earlier versions cannot be guaranteed.
iPhone 15 Pro Max, iPhone 15 Pro, iPhone 15 Plus, iPhone 15, iPhone 14 Pro Max, iPhone 14 Pro, iPhone 14 Plus, iPhone 14, iPhone SE (3rd generation), iPhone 13 Pro Max, iPhone 13 Pro, iPhone 13, iPhone 13 mini, iPhone 12 Pro Max, iPhone 12 Pro, iPhone 12, iPhone 12 mini, iPhone SE (2nd generation), iPhone 11 Pro Max, iPhone 11 Pro, iPhone 11, iPhone XS Max, iPhone XS, iPhone XR, iPhone X, iPhone 8 Plus, iPhone 8, iPhone 7 Plus, iPhone 7, iPhone SE, iPhone 6s Plus, iPhone 6s, iPhone 6 Plus, iPhone 6

■ iPod main screen example



- ① Artwork display
- ② Information display*
- ③ Elapsed time/Total time for playing Repeat mode
- ④ Displays the iPod List screen
- ⑤ Shuffle mode
- ⑥ []repeat_off, []repeat_one, []repeat_all,
- ⑦ Finds the beginning of next chapter
- ⑧ Pause and Play
- ⑨ Finds the beginning of the current file/Finds a previous file within 3 second after playback starts/Fast-reverses when touched for at least 2 second

* Podcast mode.

Playback

- 1 Touch the **HOME** button and select iPod mode. The display shows the iPod mode screen.

- 2 Touch [] or [] to select the desired track (file).

Returning to the beginning of the previous track (file):

Touch [].

Fast reverse the current track :

Touch and hold 2s [].

Advancing to the beginning of the next track (file) :

Touch [].

Fast forward the current track :

Touch and hold 2s [].

- 3 To pause playback, touch [].

Touching [] again will resume playback.

- If a song is playing on the iPhone before it is connected to the unit, it will continue playing when it is connected.
- An episode may have several chapters. The chapter can be changed by touching [] or [].
- If the artist, album or song name, created in iTunes, has too many characters, songs may not be played back when connected to the unit. Therefore, a maximum of 255 characters is recommended. The maximum number of characters for the unit is 255.
- Some characters may not be correctly displayed.

Searching for a Music File

<Music Search Menu>

Hierarchy 1	Hierarchy 2	Hierarchy 3	Hierarchy 4
Radio	—	—	—
Playlists	Songs	—	—
Artists	Albums	Songs	—
Albums	Songs	—	—
Songs	—	—	—
Genres	Artists	Albums	Songs
Composers	Albums	Songs	—
Podcasts	Episodes	—	—
Audiobook	—	—	—

For example: Searching by Artist name

The following example explains how an Artists search is performed.

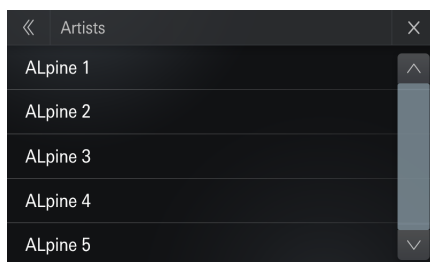

1 Touch [Q] (Search) during playback.

2 Touch [Artists].

The Artists search screen is displayed.

3 Select the desired artist.

4 Touch the desired album's name.

All songs of the selected album are displayed

5 Touch the desired song's name.

The selected song is played back.

• If you touch [<<], the category browsing mode screen is displayed.

Repeat Play

1 Touch [].

• The [] button displays the currently selected mode.

2 Select your desired Repeat mode.

ALL : All files are repeatedly played back.

One : Only the file currently playing is repeatedly played back.

OFF : Repeat mode is Off.

Shuffle Play

1 Touch [].

• The [] button displays the currently selected mode.

2 Shuffle mode is only valid in [ALL] [One] [OFF].

3 When in [One] touch [], automatically switch [ALL].

SiriusXM® Satellite Radio Operation (Optional)

SiriusXM Tuner operation:

When an optional SiriusXM Tuner is connected to this unit, the following operations may be performed.

■ SiriusXM main screen example



- ① Band button
Switches a band.
- ② Tune
Select the specified channel manually
- ③ Information display
channel name, Artist Basic, Song Basic, Cat name
- ④ Preset buttons
Displays the preset channels with a short touch.
Touch for at least 1.5 second to memorize the current channel as a preset channel.
Select the channel number
- ⑤ Displays the SiriusXM setup screen
- ⑥ Displays the SiriusXM List screen
 - 📶 All channel: Displays all channel
 - 📶 Category: Select channel category
 - 123 Tune: Select the specified channel manually
- ⑦ Changes to the next channel
- ⑧ Changes to the previous channel

Receiving Channels with the SiriusXM Tuner

About SiriusXM Satellite Radio

Only SiriusXM brings you more of what you love to listen to, all in one place. Get over 140 channels, including commercial-free music plus the best sports, news, talk, comedy and entertainment. Welcome to the world of satellite radio. A SiriusXM Vehicle Tuner and Subscription are required. For more information, visit www.siriusxm.com.

In the USA, you can activate online or by calling SiriusXM Listener Care:

- Visit www.siriusxm.com/activatenow
- Call SiriusXM Listener Care at 1-866-635-2349

For Canadian Subscriptions, please contact:

- Visit www.siriusxm.ca/activate
- Call SiriusXM Customer Care at 1-888-539-7474
- The SiriusXM Satellite Radio controls on this unit are available only when a SiriusXM Tuner is connected.

- 1 Touch the **⏪** (HOME) button and select SiriusXM mode. The display shows the SiriusXM mode screen.
- 2 Touch [**⏪**] or [**⏩**] to select the desired channel. Touching and holding either button will rapidly browse through the channels.

- Refer to the SiriusXM Tuner User Guide for details on how to install the SiriusXM Tuner.

Tuning Channels by Category

Channels are grouped into categories based on the type of content heard on the channels.

- 1 Touch [**⏪**] or [**⏩**] to select the **category browsing mode**. The channels within the category of the current channel are listed.

■ Category browsing mode screen example

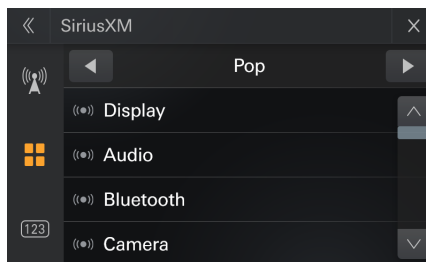

- 2 Select the desired channel.

Checking the Sirius XM Radio ID Number

To subscribe to the SiriusXM Satellite Radio service, it is necessary to locate and identify the Radio ID of your SiriusXM Tuner. You can check the Radio ID on the bottom surface of the SiriusXM Tuner box. You can also check it from this unit by performing the following procedure.

1 While receiving SiriusXM Radio, touch [◀] or [▶] to select channel "0".

The unit displays the Radio ID number.

2 To cancel the Radio ID number display, change the channel to a channel other than "0".

- The SiriusXM Radio ID does not contain the letters I, O, S, or F.

Storing Channel Presets

You can store 18 of your favorite SiriusXM channels for easy recall with Preset buttons.

1 Long press the Preset number you can store the channel.
A maximum of 6 channels can be displayed on a page.

2 Repeat the procedure to store up to 17 other channels.
A total of 18 channels can be stored in the preset memory.

- If you store a new channel into a preset which already has a channel assigned, the current channel will be cleared and replaced with the new one.

Tuning Channels Using Presets

Touch any one of the Preset numbers you have already stored in the Preset mode screen.

The preset channel is received.

SiriusXM List

1 Touch [☰].
The list screen appears.

List item: All Channels / Category Name*/Tune

- * The Category name for the channel currently being received is displayed.
- You can switch the category by touching [◀] or [▶] on the List screen after selecting a Search item.

List by ALL Channel

- 2 Touch [☰].**
All Channels will be displayed in a list.
- 3 Touch the selected channel.**
The channel you selected is received.

Searching by Category

- 2 Touch Category Name.**
The channels within the category of the current channel are listed.
- 3 Touch the selected channel.**
The channel you selected is received.

Selecting The Channel Directly

- 1 Touch [Tune] or [123].**
The numeric keypad input screen is displayed.
- 2 Touch to input the channel number.**
- 3 Touch [OK].**
The selected channel is received.

Parental Lock Function

The Parental Control feature allows you to limit access to any SiriusXM channels, including those with mature content. When enabled, the Parental Control feature requires you to enter a passcode to tune to the locked channels. For information on setting the Parental Control passcode, see "Parental Control" (page 29).
When a locked channel is selected, "Channel [xxx] Locked" is displayed and then the numeric keypad appears for you to enter the passcode.

Input the 4-digit passcode you set in "Parental Control" (page 29).

The initial number is 0000.

- If you input a wrong passcode, "Incorrect Pass Code entered" is displayed.
- After entering the correct passcode, you can access all locked channels without entering the passcode again until the unit is powered off and then back on.

Bluetooth® Operation

Setup Before Using

About Bluetooth

Bluetooth is a wireless technology allowing communication between a mobile device or personal computer over short distances. This enables a hands-free call or data transmission between Bluetooth compatible devices. Bluetooth transmission is available in the unlicensed 2.4 GHz spectrum if the distance between devices is within 10 meters. For details, refer to the Bluetooth website (<http://www.bluetooth.com/>).

- Depending on the Bluetooth version, a Bluetooth compatible device may not be able to communicate with this unit.
- Proper function of this unit with all Bluetooth compatible devices is not guaranteed. For handling of the Bluetooth compatible device, consult your Alpine dealer or Alpine website.
- Depending on the surroundings, Bluetooth wireless connection may be unstable.
- When you place a call, or perform setup operations, be sure to stop your car in a safe place.
- Depending on the connected Bluetooth compatible device(s), the function may differ. Also refer to the Owner's Manual of the connected device(s).

About the Hands-free Phone

Hands-free calls are possible when using a HFP (Hands-Free Profile) compatible mobile phone with this unit.

- Avoid performing a hands-free call in heavy traffic or on narrow or winding streets.
- Close the windows while calling to reduce background noise.
- If both calling parties are using hands-free devices, or the call is made in a noisy location, difficulty hearing the other person's voice is normal.
- Depending on telephone line conditions or certain mobile devices used, voices may sound unnatural.
- When using a microphone, speak as directly as you can into the microphone to obtain the best sound quality.
- Certain mobile phone features are dependent on the capabilities and settings of your service provider's network. Additionally, certain features may not be activated by your service provider, and/or the provider's network settings may limit the feature's functionality. Always contact your service provider about feature availability and functionality. All features, functionality, and other product specifications, as well as the information contained in the Owner's Manual are based upon the latest available information and are believed to be accurate at the time of printing. Alpine reserves the right to change or modify any information or specifications without notice or obligation.

Before Using Bluetooth

Before using the hands-free phone/audio function, the following settings need to be made.

Register a Bluetooth device in this unit.

- See "Bluetooth Setup" (page 38).
- You can search for this unit using a Bluetooth compatible device, and then connect that Bluetooth compatible device to this unit. The device name of this unit is "iLX-W770" and the initial number of the passcode is "0000." Also refer to the Owner's Manual of the connected device(s).

Hands-free Phone Control

Touch **[Bluetooth]** in the HOME screen to display the Bluetooth menu screen.



[Phone] button

Phone menu screen example

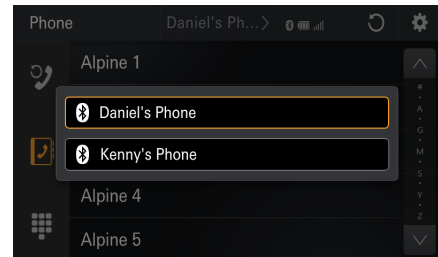

Phone selection

You can select which phone to display after connecting two phones.



Recent Events list

You can display up to 100 items, such as phone numbers of the most recent incoming calls, missed calls and outgoing calls, and contact names that are registered in the Phone Book. When 100 items exist in the list, the oldest item is deleted when a further item is to be added.



Contacts list

You can make a phone call from the Phone Book, or edit the Phone book.



Keypad screen

Use to type a phone number.

Answering a Call

- 1 An incoming call triggers the ringtone and an incoming call display.

Phone incoming screen example

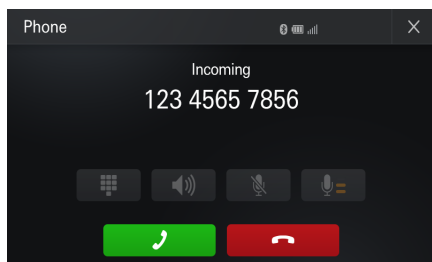

Two phones incoming screen example

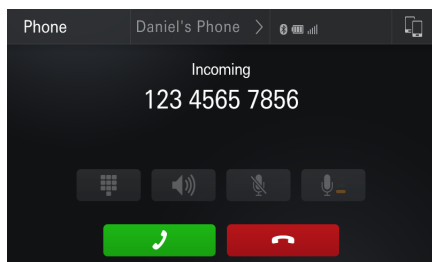

Touch [] to select which incoming call you want to answer.

When the unit is answering, another phone incoming screen example

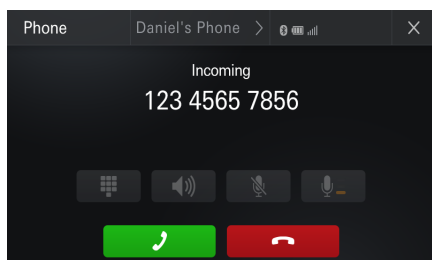

Touch [X] to close the incoming screen without ending the call.

2 Touch [] (Call).

The call starts.



- ① Touch [] Display Keypad screen
- ② Touch switch Car speaker [] Or Phone speaker []
- ③ Touch [] switch mute on/ off
- ④ Adjust the volume level

- During a call, the audio for the current mode on the unit is muted. After calling, playback will resume.
- When the caller's number is transmitted to the system, if the caller's name is stored in the phone book, the name is displayed. If the name is not stored, the number is displayed.
- Touch [Decline] to reject an incoming call.

Hanging up the Telephone

1 Touch [] End Call.

The call finishes.

Calling

Making a phone call using the Phone Menu

Entering a Phone Number to Make a Call

1 Touch [Keypad].

The number input screen (Keypad) appears.

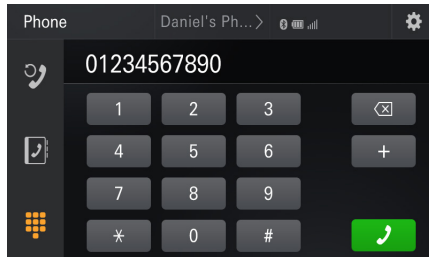

Touch [X] to delete an entered number.

2 Enter the phone number you wish to call.

- You can enter up to 20 digits.

3 Touch [Call].

The phone call is started.

- To change the Bluetooth device, see "Bluetooth Setup" (page 38).

Making a phone call from the Recent Events list

1 Touch [Recent Events] to change to the Recent Events list screen.

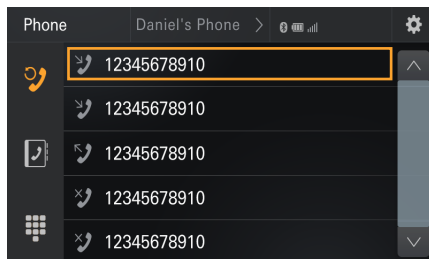

2 Touch the name of the contact or number you want to call.

The phone call is started.

Calling from the Contacts list (Phone Book)

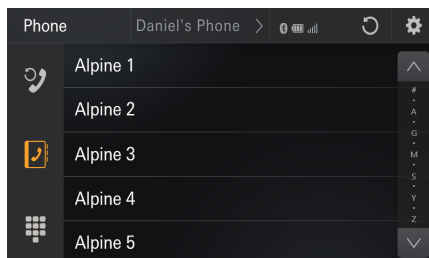

1 Touch [Contacts] to change to the Contacts list screen.

2 Touch the name of the contact or number you want to call.

3 Touch the phone number.

The Phone Operation screen is displayed.

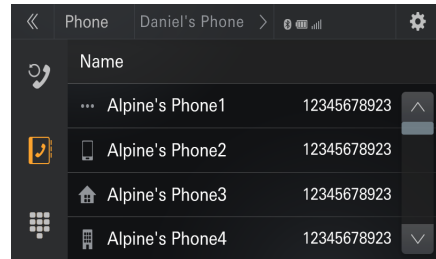

4 Touch the number you want to call.

The phone call is started

Siri

Establish iPhone Bluetooth connection and wake up Siri from phone , below interface will pop up and the voice output is from the unit.



Phone Operation Screen



Adjusting the Speech Volume

You can adjust Mic. Level (Microphone Level).

Level 1: Level 2: Level 3:

Changing the Voice Output

The voice output for calls is switchable between car speakers and the mobile phone speaker.

Touch [] or [].

DTMF (Touch-Tone) Function

Transmits a DTMF (Touch-Tone) during a call.

1 Touch [] (Keypad).

The number input screen (Keypad) appears.

2 Input number.

- You can transmit a Touch-Tone signal during a call.

Phone Book Function

Phone Book screen example

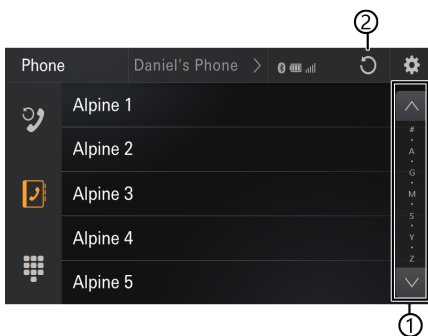

- Use to narrow down your search for names, etc.
- You can synchronize the system's phone book with the mobile phone's phone book.

Synchronizing the Phone Book

Touch [].

Synchronization of the phone books starts.

- You can store up to 1,000 registered name in the phone book.
- You can store up to 5 phone numbers by one person's name.

Bluetooth® Audio

If a Bluetooth compatible mobile phone, portable player, etc. is connected by wireless, you can play back a song (operation is controllable from the unit).

- Operation may vary, depending on the Bluetooth compatible device

Bluetooth Audio main screen example



- Default image display
- Information display
- Elapsed time/Total time for playing
- Search device
- Shuffle mode
- []repeat_off, []repeat_one, []repeat_all
- Finds the beginning of next chapter
- Pause and Play
- Finds the previous file

- Song title/Artist title/Album title/Elapsed time do not display for AVRCP Ver. 1.0.
- To play back audio, a mobile phone or a portable player conforming to A2DP (Advanced Audio Distribution Profile) or AVRCP (Audio/Video Remote Control Profile) is required.
Not all functions work with all devices.
- During a call, sound on the Bluetooth audio source is paused.

Compatible AVRCP versions: 1.0, 1.3, 1.4, 1.5, 1.6.2

- Available functions may differ depending on the AVRCP version.

Playback

- 1 Touch the **HOME** button and select **Bluetooth Audio mode**.
The display shows the Bluetooth Audio mode screen.

- 2 Touch [**◀◀**] or [**▶▶**] to select the desired track (file).

Returns the beginning of the previous file:

Touch [**◀◀**].

Advance to the beginning of the next file:

Touch [**▶▶**].

- 3 To pause playback, touch [**||**].

Repeat Play

Available for AVRCP Ver. 1.0, 1.3, 1.4, 1.5, 1.6.2.

- 1 Touch [**⏮**].
 - [**⏮**] displays the currently selected mode.

- 2 Select your desired Repeat mode.
The selected Repeat mode changes the button.

ALL **⏮**: Once all of the songs have finished playing, play back is repeated, starting with the first song.

One **⏮**: Only the track currently playing is repeatedly played back.

OFF **⏮**: Repeat mode is Off.

- Operations may differ depending on the connected Bluetooth compatible device.

Shuffle Play

Available for AVRCP Ver. 1.0, 1.3, 1.4, 1.5, 1.6.2.

Touch [**🔀**].

- All songs in the Bluetooth compatible devices are played back in random sequence. Any one song does not play back again until all songs have been played back.
- Operations may differ depending on the connected Bluetooth compatible device.

AUX Operation (Optional)

AUX Operation

- Through AUX connection, you can display the videos or images output from other devices
- For safety, video image can not be displayed when vehicle is moving. To view the video image, please stop in a safe zone and apply the parking brake.
- A mini AV cable is required to make the connection (sold separately). Further details are given in <<Installation Manual>>

AUX screen example

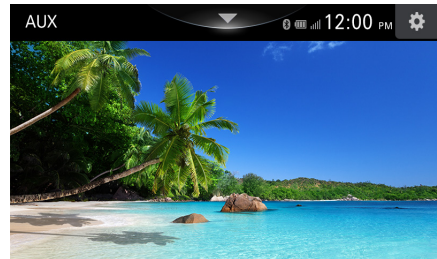

- 1 Touch [**HOME**].
- 2 Touch [**AUX**] Display AUX screen

Camera Operation (Optional)

Camera screen example



Setting item:

Display Reverse or 2nd camera video

Function button:

Camera Guide Off (Initial setting) / On
Caution prompt displays top/ bottom
Camera switch to display Rear/2nd camera
Close camera image

Camera Operation

Displaying the Camera Image from the Menu screen

1 Touch the (HOME) button.
The HOME screen is displayed

2 Touch [Camera].

- Touch the screen while the camera image is being displayed,
- It displays [X] close, [V] / [^] Caution display on button/top, guide line and camera switch keys.

About the Rear/Front Camera Guide

■ Indication mark meaning

When 2nd camera was set to Front Camera, and the monitor switches to the front view camera image. Guides appear to help visualize the car's width and distance from the front bumper.

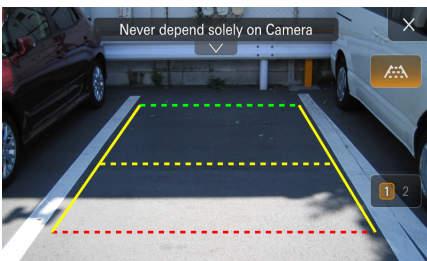

Car width extension marks (red, yellow and green in order of distance)

If properly calibrated, the marks indicate the car's width. This helps guide the car's path when driving in a straight line. The marks represent the distance from the front of the car (from the front end of the bumper).

About the Side Camera Guide

When the 2nd camera was set to Side camera(left or right), and the monitor switches to the left or right view camera image. Guides appear to help visualize the car's width and distance from the left or right Fender.

Left camera image

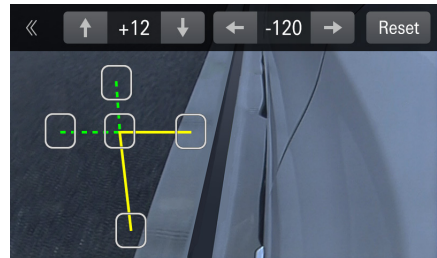

right camera image

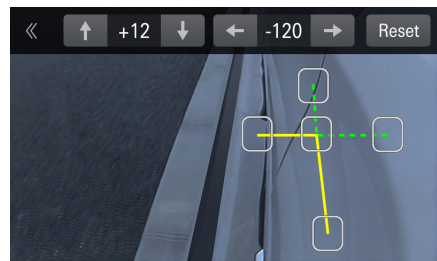

Connection Operation



[Connetion] is used to connect/disconnect CarPlay/Android Auto, and displays the Bluetooth connection status of HFP, A2DP and RFCOMM, and saves the phone's Wi-Fi connection records.

- ① The connection phone name
- ② The connection state
The icon highlight indicates available, set-ash indicates unavailable, hide indicates nonsupport;
- ③ Connection switch and delete button
The switch button is [Disconnect], it indicates that both HFP and A2DP are available,
The switch button is [Connect] which indicates that at least one of HFP and A2DP is unavailable.
[Delete] button Delete the phone connection record.

Sound Boost and Lighting link (Optional)



- ① Current screen On/Off
 - ② Sub.Woofer On/Off
Linkage with the Settings in sound (page 35)
 - ③ Adjust Sub.Woofer Level
Linkage with the Settings in sound (page 35)
 - ④ Sub.Woofer Phase
Linkage with the Settings in sound (page 35)
0° (Initial setting), 180°
 - ⑤ Lighting Link setting
can change the LED color of the system model, the keyColor of this unit, and the background color in tandem.
** Only when the Color Link is ON, the keyColor and background color will change*
 - ⑥ Displays sound setup icon
touch the icon to sound setup screen
 - ⑦ Max Mid Bass On/Off
Linkage with the Settings in sound (page 33)
 - ⑧ Max Bass On/Off
Linkage with the Settings in sound (page 33)
- If Lightinglink is OFF in the settings, this icon will not be displayed (page 42).

Lighting Link Setting Operation

When operating the Lighting color of the system model with Lightinglink, it is necessary to connect a model that supports Lightinglink. Check the Alpine website for compatible models.

- 1 Touch [■■■].
- 2 Touch [▼] Display Sound Boost screen
- 3 Touch [●] Display Lighting Link screen

Lighting Link screen example



- ① LED On/Off
LED OFF: Premium Direct Color and LED Brightness and LED Lighting Speed, Other Color is grayed out and cannot be selected. And the Lighting of the connected system turns off.
- ② Select Premium Direct Color
Blue, Red, Amber, Green, White
Each Lighting color changes in conjunction. Please refer to page 27 for the changed parts and their colors.
- ③ Adjust LED Brightness
Adjusts the brightness level of the LEDs on Lightinglink-enabled models
-3 - +3 Initial: 0
- ④ Adjust LED Light Blinking Speed
- ⑤ Select Other Color
Select Premium Direct Color or Dynamic mode

LED Brightness

Adjusts the brightness level of the LEDs on Lightinglink-enabled models

Setting item:

LED Brightness

Setting contents:

-3~+3,0(Initial setting)

LED Lighting Speed

Adjusts the level of LED Light Blinking Speed for Lightinglink compatible models

Setting item:

LED Lighting Speed

Setting contents:

-5~+5,0(Initial setting)

Other Color



- Please connect the Lighting Link compatible model with the lighting level and speed setting values set to 0.

Lighting Link settings Colors

- Lighting Link has 8 modes.

Lighting Link Setting Colors	Premium Direct color select					Other colors	Dynamic Mode	LED OFF
	Red	Blue	Green	Amber	White	7 colors		
Lighting Link & Sound boost background, Sub.W Ring Color	Red	Blue	Green	Amber	White	Rainbow1	Rainbow2	-
Key Color*	Red	Blue	Green	Amber	White	White	White	select
Background Screen Color*	Red	Blue	Green	Amber	White	White	White	User

* key Color and Background Screen Color is linked when Lighting Link is ON. Please see page 32.

* If you select a color with the Lighting Link function, it will all change to the selected color pattern regardless of the current color settings for each.

* BackgroundScreen color and keyColor can be changed individually after setting Lighting Link (page 32).

- Lighting Link System model is option.

Setup

Setup Operation

To display the Setup Menu screen:

Your vehicle must be parked with the ignition key in the ACC or ON position. To do this, follow the procedures below.

- 1 Bring your vehicle to a complete stop at a safe location. Engage the parking brake.
- 2 Release the parking brake. (For safety, release the parking brake while depressing the foot brake pedal).
- 3 Engage the parking brake again.

- For automatic transmission vehicles, place the transmission lever in the Park position.
- "Sound Setup" (page 33) can be set even not engaging the parking brake.

Now, the locking system for the Setup operation has been released. Engaging the parking brake can reactivate the Setup Menu, as long as the car's ignition has not been turned off. It is not necessary to repeat the above procedure (1 through 3).

Each time the ignition is turned OFF, perform the above procedure.

1 Touch the (HOME) button.

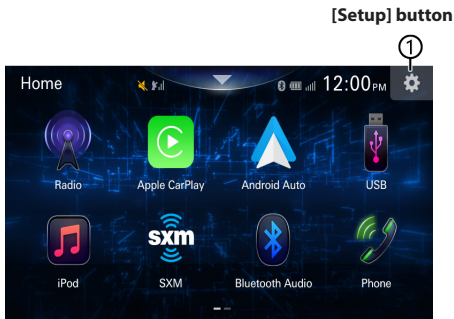

The HOME screen is displayed.

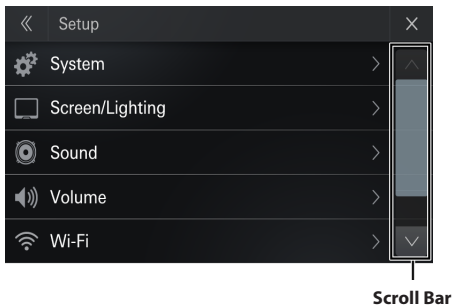

2 Touch [Setup] button.

The Setup main screen is displayed.



* Touch [] or [] to show further hierarchies.

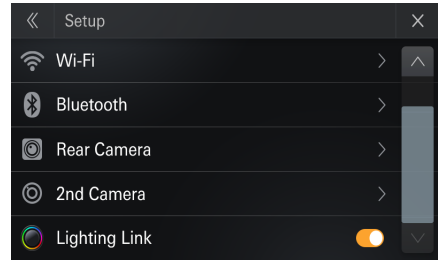

3 Touch the required setting list, then touch the setting item.

Setting items:

System: See "System Setup" (page 28).

Screen/Lighting: See "Screen/Lighting Setup" (page 32).

Sound: See "Sound Setup" (page 33).

Volume: See "Volume Setup" (page 38).

Bluetooth: See "Bluetooth Setup" (page 38).

Wi-Fi: See "Wi-Fi Setup" (page 39).

Rear Camera: See "Rear Camera Setup" (page 40).

2nd Camera: See "2nd Camera Setup" (page 41).

Lighting Link ON/OFF: See "Lighting Link" (page 42).

System Setup

[System] is selected on the Setup menu screen.

Setting item:

System

Setting contents:

Beep, Language, Time Adjust, SiriusXM, Product Information, Software License, Connection Status, Demo Mode, Reset

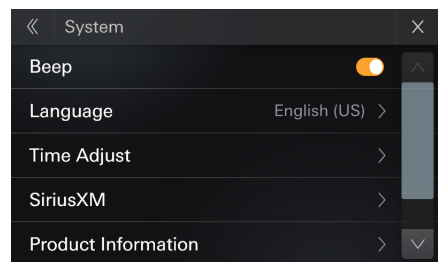

Beep Setup

You can change the volume of the sound heard when a button is touched.

Setting item:

Beep

Setting contents:

Off, On (Initial setting)

Language Setup

[**Language**] is selected on the System Setup Menu screen. The Setup menu, feedback information, etc. for this unit can be changed to appear in the selected language.

Setting item:
Language

Setting contents:
English (US), French, Spanish, Portuguese

- The currently selected language is displayed.

Time Adjust Setup

[**Time Adjust**] is selected on the System Setup Menu screen.

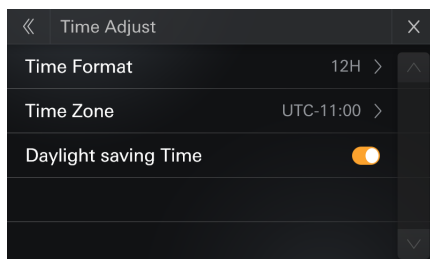

Time Format

Setting item:
Time Format

Setting items:
12h, 24h (Initial setting)

Time Zone

Setting item:
Time Zone

Setting contents:
UTC-12.00h~UTC+14.00

Daylight saving Time ON/OFF

Setting item:
Daylight saving Time

Setting contents:
Off (Initial setting), On

SiriusXM Setup

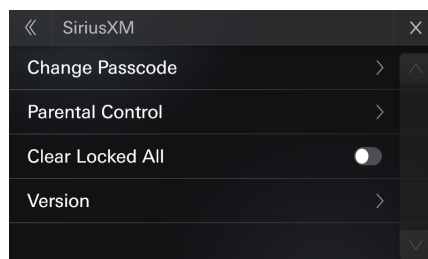

Change Passcode

Setting item:
Change Passcode

Setting contents:
Edit the passcode.

- 1 Enter the current passcode and then touch [OK].
- 2 Enter the new passcode and then touch [OK].
- 3 Enter the confirm passcode and then touch [OK].

Parental Control

You can lock out channels with passcode protection. Channels that are locked cannot be accessed without entering the passcode. You can unlock a channel or change the passcode using this menu option.

Setting item:
Parental Lock On/Off

- 1 Touch [Parental Control].
A passcode input screen is displayed.
- 2 Touch the numeric keypad to input a 4-digit passcode
The initial default 4-digit passcode is set to 0000.
After entering the digit, it is displayed as "●".
Touch [Clear] to delete all entered numbers.
- 3 Touch [OK].
The channels list screen is displayed.

Setting the Lock status of individual channels

- 4 Touch [Channels].
 - To lock the channel, touch the appropriate channel.
 - When you touch the locked channel, the channel is unlocked.
🔒 appears and the channel is locked.

Clear Locked All

Setting item:

Clear Locked All

Setting contents:

Off (Initial setting) / On

- Touch the switch, enter the current passcode then touch [OK].
- All stations will be cleared when Off. Locking again will change to ON automatically

Changing the Lock Passcode

1 Touch [Change Passcode].

The numeric keypad screen is displayed.

2 Use the keypad to enter the current (old) 4-digit passcode, and then touch [OK].

The initial passcode is set to "0000."

After entering the digit, it is displayed as ●.

Touch [Clear] to delete all entered numbers.

3 Use the keypad to enter the new 4-digit passcode, and then touch [OK].

4 Use the keypad to enter the new 4-digit passcode a second time to verify it, and then touch [OK].

Remember to keep a note of the passcode in a safe place in case you forget the code.

Version

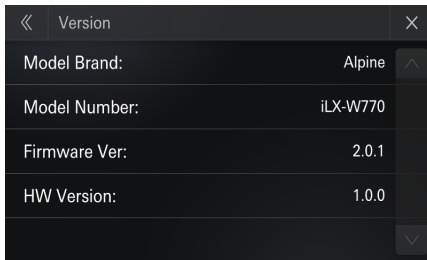

Setting item:

Version

Setting contents:

Model Brand, Model Number, Firmware Version, Hardware Version.

Product Information



Setting item:

Model Number, MCU, SOC, Interface FW Version, Interface HW Version

Updating the firmware version



1 Download the firmware update file into your computer.

2 Inset a USB with FAT32 format into your computer, copy the correct upgrade file to the root directory

3 Connect the USB storage device to this product.

4 Touch [setup]>[System setup]>[Product Information]>[Update].

The firmware update file information will be read

5 After reading Touch [Update]

Follow the on-screen prompts to update the firmware.

- This product will reset automatically after the firmware update is completed if the update is successful.
- If an error message on the screen, Repeat the preceding steps

Software License

[Software License] Displaying the open source software license.

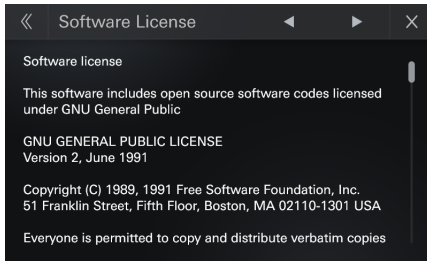

Connection Status

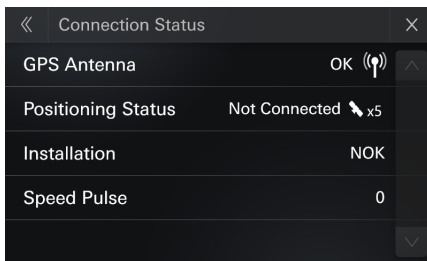

GPS Antenna

- Display when there is an antenna [OK]
- Display without antenna [NOK]



- OK Antenna: Yes Signal:0
- OK Antenna: Yes Signal:1
- OK Antenna: Yes Signal:2
- OK Antenna: Yes Signal:3
- NOK Antenna: No

Positioning Status

- Display [position]: When there is positioning
- Display [Not Available]: When there is no positioning
- Display [Not Connected]: When the serial port of the GPS module is not available

Installation

- Install and learn to successfully display [OK],
- No learning success display [NOK]

Speed Pulse

- Display pulse number "XXX" in unit time, and display "0" if not obtained.

DEMO MODE

[Demo Mode] The images of the demo mode are pre stored in flash. Execute loop playback, replace images every 8 seconds.

Setting contents:

On,Off(Initial setting)

Entry condition

- 1 No operation screen within 120 seconds
If any situation occurs that causes page switching, button operation, or touch operation, restart the timer after 120 seconds

Exit condition

- 1 During the playback of the demo mode, if it causes page switching, button operation, or touch operation, the demo mode will stop
- 2 In driving, if the demo mode is running, it stops running and returns to the previous mode

- Recommend switching it off when installing it on your vehicle

Reset

[Reset] is selected on the System Setup Menu screen. You can initialize all data, to restore the factory settings.

Setting item:

Reset

1 Touch [Reset].

2 After the confirmation message appears, touch [Yes].

The system starts initialization.

- Do not turn on/off the power, change the ignition key position or until system restart is completed.

Screen/Lighting Setup

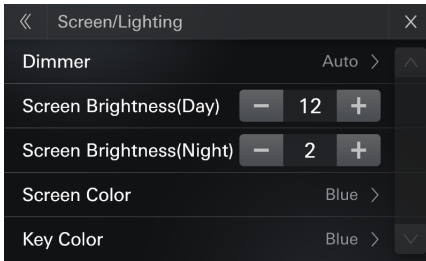

Setting item:

Screen/Lighting

Setting contents:

Dimmer, Screen Brightness (Day), Screen Brightness (Night), Screen Color, Key Color

Dimmer

You can set day, night and auto three modes in dimmer

1. The screen backlighting brightness can be set in day/night mode
2. Auto Mode adjusts the backlighting brightness to the appropriate day/night brightness setting value based on the current ambient brightness

Setting contents:

Day, Night, Auto (Initial setting)

Day:

The backlight brightness is adjusted by setting the screen brightness setting (Day)

Night:

The backlight brightness is adjusted by setting the screen brightness setting (night)

Auto:

Automatically adjust the backlight brightness and select the Screen brightness (Day) or Screen Brightness (Night) setting value as the backlight brightness value based on the Day/Night lighting threshold

Screen Brightness (Day)

Setting item:

Level

Setting contents:

1 to 32

Screen Brightness (Night)

Setting item:

Level

Setting contents:

1 to 32

Screen Color

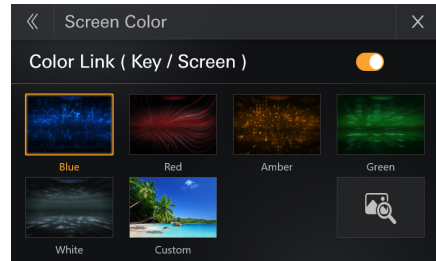

Setting item:

Background Picture

Setting contents:

You can set blue, red, amber, green, white five colors or other background pictures, you can also select the background picture to be set from the USB flash drive

Setting item:

Background custom

- 1 Insert a USB flash drive.
- 2 Touch [🖼️] to the Wallpaper screen.
- 3 Select the custom picture.

Setting item:

Color Link (Key/Screen)

Setting contents:

Color link ON (Initial setting)

- You can select ON/OFF whether the button light and background picture linkage.

Key Color

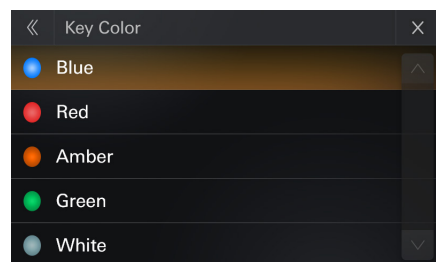

Setting item:

Key Color

Setting contents:

blue, red, amber, green, white

- Key color Settings can be set blue, red, amber, green, white five colors
- When the Color Link is ON, key Color is grayed out and cannot be selected.
- When the Lighting Link function is used, that selection takes precedence and all colors are switched (page 27).
- You can change the Key Color individually after selecting the color with the Lighting Link function.

Sound Setup

[Sound] is selected on the Setup menu screen.

You can set up items related to the sound quality.

<Setting item>

Fader/Balance (page 33)
Bass/Treble (page 33)
EQ Setting (page 33)
Preset EQ (page 34)
X-Over (page 35)
Speaker Level (page 36)
Time Correction (page 35)
Sub Woofer (page 35)
Defeat (page 36)

* Touch [▲] or [▼] to show further.

Setting the Fader/Balance



- ① Back
Exit[Fader/Balance]Return [SOUND].
- ② Close
Close the current screen and return to the source screen
- ③ Fader/Balance Image area
Touch the desired point within the image area, or touch [◀], [▶], [▲] or [▼].

Fader:

[15]Front to [15]Rear

Balance:

[15]Left to [15]Right

- To reset to the initial setting (Fader: F=R, Balance: L=R), touch [⊕].

Adjusting the Bass/Middle/Treble

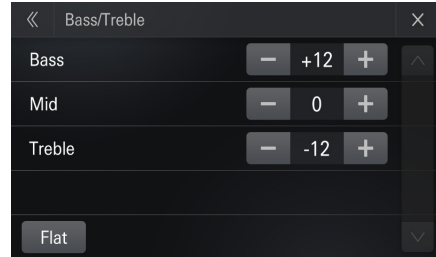

Touch [+] or [-] for each item to be adjusted.

Setting item:

Bass, Middle, Treble

Setting contents:

-12 to 12 (Initial setting: 0)

- To reset the initial setting (Bass: 0, Middle: 0, Treble: 0), touch [Flat].
- When the Defeat setting is [On], you cannot perform the set up.

Adjusting the Graphic Equalizer Curve (EQ)

Setting item:

EQ

- When the Defeat setting is [On], you cannot perform the set up.

1 Adjust the EQ to your preference.



Adjusting the Band

Touch [Band] to select the band to be adjusted.

Band1 → Band2 → ... → Band8 → Band13 → Band1

- You can select a band directly by touching the screen.

Adjusting the Frequency

Touch of "Frequency" to adjust the frequency of the selected band

Adjustable frequency bands:

Band1:	50 Hz
Band2:	80 Hz
Band3:	125 Hz
Band4:	200 Hz
Band5:	315 Hz
Band6:	500 Hz
Band7:	800 Hz
Band8:	1.25k Hz
Band9:	2k Hz
Band10:	3.15k Hz
Band11:	5k Hz
Band12:	8k Hz
Band13:	12.5k Hz

Adjusting the Level

- 1 **Select Band Slide up or down to adjust the level of selected band.**

Setting contents:

-12 to 12 (Initial setting: 0)

- 2 **To adjust another band, repeat step 1, and adjust all bands.**

- 3 **To store the adjusted setting value, touch and hold [Preset 1], [Preset 2], or [Preset 3] for at least 2 seconds.**

- Band2, Band7 and Band12 are the same as the Bass and Middle controls. For details on setting Bass and Treble, see "Adjusting the Bass/Middle/Treble" (page 33).
- Settings exceeding the frequency of adjacent bands are not available
- While adjusting the EQ Setting, you should consider the frequency response of the connected speakers.
- When you apply the adjusted Band in the EQ setting screen, Preset EQ (page 34) is unselected
- Touch [Flat] to initialize all values.

Calling the EQ Setting adjusted value

Calling the pre-set EQ Setting adjusted value.

Touch [Preset 1], [Preset 2], or [Preset 3] on the EQ Setting screen.

The setting stored in the Preset will be recalled.

Setting an Equalizer

6 typical equalizer settings are preset at the factory for a variety of musical source material. You can also preset an equalizer by customizing.

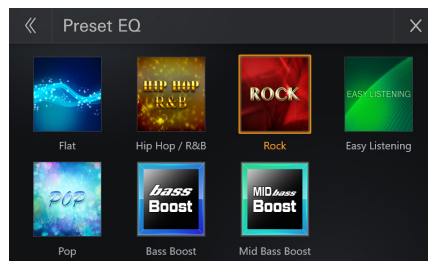

Setting item:

Preset EQ

Setting contents:

Flat (Initial setting), Hip Hop/R&B, Rock, Easy Listening, Pop, Bass Boost Mid Bass Boost

- When the Defeat setting is [On], you cannot perform the set up.
- Only one type can be set .
- you can set [preset1/preset2/preset3]in the EQ setting screen. (page 33)
- When you set [preset1/preset2/preset3]in the EQ setting screen.(page 33). Preset EQ is unselected

Setting the Subwoofer

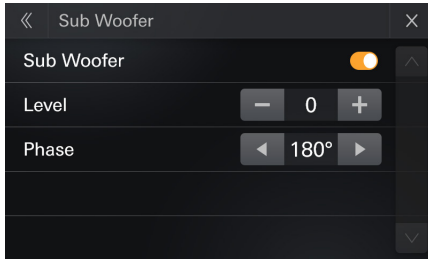

Turning Subwoofer ON/OFF

If an optional subwoofer is connected to the unit, make the following setting.

Setting item:
Sub Woofer

Setting contents:
Off (Initial setting), On

Adjusting the Subwoofer Level

Setting item:
Level

Setting contents:
0 (Initial setting) to 15

- This setting is only available when "Sub Woofer" is set to [On].

Setting the Subwoofer Phase

The subwoofer output phase is toggled Subwoofer Normal (0°) or Subwoofer Reverse (180°).

Setting item:
Phase

Setting contents:
0° (Initial setting), 180°

- This setting is only available when "Sub Woofer" is set to [On].

Adjusting the Crossover Settings (X-Over)

Before performing the following procedures, see "About the Crossover" (page 36).

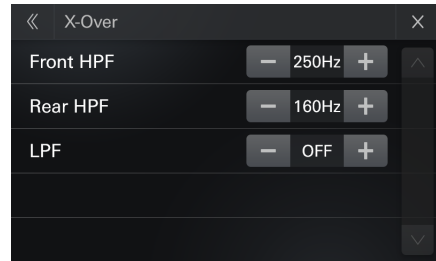

Selecting the Front HPF

Setting item:
Front HPF

Setting contents:
Off (Initial setting)/ 25 / 32 / 40 / 50 / 63 / 80 / 100 / 125 / 160 / 200 / 250 Hz

Selecting the Rear HPF

Setting contents:
Rear HPF

Setting contents:
Off (Initial setting)/ 25 / 32 / 40 / 50 / 63 / 80 / 100 / 125 / 160 / 200 / 250 Hz

Selecting the LPF

Setting contents:
LPF

Setting contents:
Off (Initial setting)/ 25 / 32 / 40 / 50 / 63 / 80 / 100 / 125 / 160 / 200 / 250 Hz

- This setting is only available when "Sub Woofer" is set to [On].

Adjusting the Time Correction (TCR)

Before performing the following procedures, see "About Time Correction" (page 37).

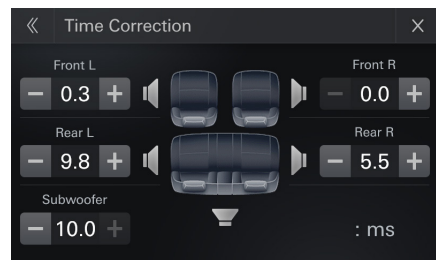

Setting item:
TCR

Touch [-] or [+] for each speaker to adjust the time .
0.0 msec to 10.0 msec (0.1 msec/step)

- If the Subwoofer setting is [Off], the Subwoofer setting cannot be edited (page 35).

Setting the Speaker Level

Setting item:

Speaker Level

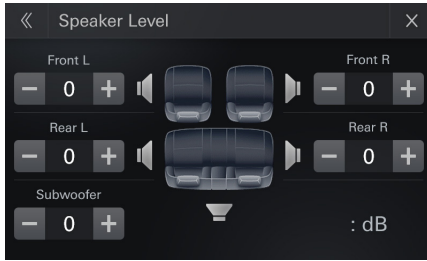

Touch [—] or [+] for each speaker to adjust the Speaker.
-24dB to 10dB (0.1 dB/step)

Setting Defeat

If Defeat is [On], the EQ and Equalizer setting are turned Off. This disables any settings made for these functions.

Setting item:

Defeat

Setting contents:

Off (Initial setting) / On

About the Crossover

Crossover (X-Over):

This unit is equipped with an active crossover. The crossover limits the frequencies delivered to the outputs. Each channel is controlled independently. Thus, each speaker pair can be driven by the frequencies for which they have been optimally designed.

The crossover adjusts the HPF (high pass filter) or LPF (low pass filter) of each band.

Adjustments should be made according to the reproduction characteristics of the speakers. Depending on the speakers, a passive network may not be necessary. If you are unsure about this point, please consult your authorized Alpine dealer.

25 Hz, 32Hz, 40Hz, 50Hz, 63Hz, 80Hz

	Cut-off frequency	
	HPF	LPF
Subwoofer (LPF)	---	25Hz, 32Hz, 40Hz, 50Hz, 63Hz, 80Hz, 100Hz, 125Hz, 160Hz, 200Hz, 250Hz
Rear speaker (HPF)	25Hz, 32Hz, 40Hz, 50Hz, 63Hz, 80Hz, 100Hz, 125Hz, 160Hz, 200Hz, 250 Hz	---
Front speaker (HPF)	25Hz, 32Hz, 40Hz, 50Hz, 63Hz, 80Hz, 100Hz, 125Hz, 160Hz, 200Hz, 250Hz	---

- **HPF (high pass filter):** Cuts the lower frequencies and allows the higher frequencies to pass.
- **LPF (low pass filter):** Cuts the higher frequencies and allows the lower frequencies to pass.
- Do not use a tweeter without the HPF on or set to a low frequency, as it may cause damage to the speaker due to the low frequency content.
- Adjustment should be made according to the recommended crossover frequency of the connected speakers. Determine the recommended crossover frequency of the speakers. Adjusting to a frequency range outside that recommended may cause damage to the speakers. For the recommended crossover frequencies of Alpine speakers, refer to the respective Owner's Manual.
We are not responsible for damage or malfunction of speakers caused by using the crossover outside the recommended value.

About Time Correction

The distance between the listener and the speakers in a car vary widely due to the complex speaker placement. This difference in the distances from the speakers to the listener creates a shift in the sounds image and frequency characteristics. This is caused by the time delay between the sound reaching the listener's right versus the left ear.

To correct this, this unit is able to delay the audio signal to the speakers closest to the listener. This effectively creates a perception of increased distance for those speakers. The listener can be placed at an equal distance between the left and right speakers for optimum staging. The adjustment will be made for each speaker in 3.4 cm steps.

Example 1. Listening Position: Front Left Seat

Adjust the time correction level of the front left speaker to a high value and the rear right to zero or a low value.

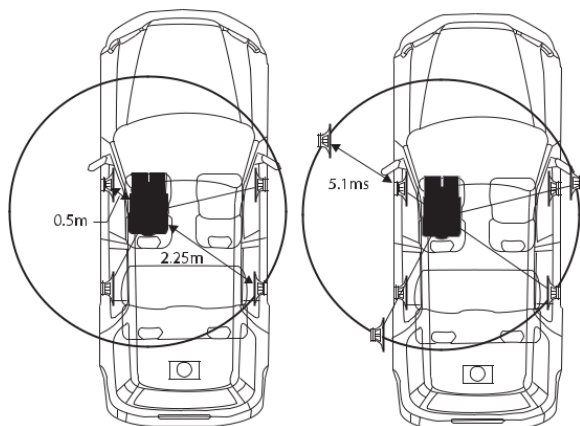

The sound is not balanced because the distance between the listening position and the various speakers is different. The difference in distance between the front left speaker and the rear right speaker is 1.75 m (68-7/8").

Here we calculate the time correction value for the front left speaker in the diagram on the above.

Conditions:

Farthest Speaker – listening position : 2.25 m (88-9/16")

Front left speaker – listening position : 0.5 m (19-11/16")

Calculation: $L = 2.25 \text{ m} - 0.5 \text{ m} = 1.75 \text{ m}$ (68-7/8")

Time correction = $1.75 \div 343 * \times 1,000 = 5.1 \text{ (ms)}$

* Speed of sound: 343 m/s (765 mph) at 20°C

In other words, giving the front left speaker a time correction value of 5.1 ms makes it seem as if its distance from the listener is the same as the distance to the farthest speaker.

Time correction eliminates the differences in the time required for the sound to reach the listening position.

The time of the front left speaker is corrected by 5.1 ms so that its sound reaches the listening position at the same time as the sound of other speakers.

Example 2. Listening Position: All Seats

Adjust the time correction level of each speaker to almost the same level.

- Sit in the listening position (driver's seat, etc.) and measure the distance (in meters) between your head and the various speakers.**
- Calculate the difference between the distance correction value to the farthest speaker and the other speakers.**

$$L = (\text{distance to farthest speaker}) - (\text{distance to other speakers})$$

These values are the time correction values for the different speakers. Setting these values to make each sound reach the listening position at the same time as the sound of other speakers.

Time Correction Value List

Time Difference (msec)	Distance (cm)	Distance (inch)	Time Difference (msec)	Distance (cm)	Distance (inch)
0.0	0.0	0.0	5.1	173.4	68.3
0.1	3.4	1.3	5.2	176.8	69.7
0.2	6.8	2.7	5.3	180.2	71.0
0.3	10.2	4.0	5.4	183.6	72.4
0.4	13.6	5.4	5.5	187.0	73.7
0.5	17.0	6.7	5.6	190.4	75.0
0.6	20.4	8.0	5.7	193.8	76.4
0.7	23.8	9.4	5.8	197.2	77.7
0.8	27.2	10.7	5.9	200.6	79.1
0.9	30.6	12.1	6.0	204.0	80.4
1.0	34.0	13.4	6.1	207.4	81.7
1.1	37.4	14.7	6.2	210.8	83.1
1.2	40.8	16.1	6.3	214.2	84.4
1.3	44.2	17.4	6.4	217.6	85.8
1.4	47.6	18.8	6.5	221.0	87.1
1.5	51.0	20.1	6.6	224.4	88.4
1.6	54.4	21.4	6.7	227.8	89.8
1.7	57.8	22.8	6.8	231.2	91.1
1.8	61.2	24.1	6.9	234.6	92.5
1.9	64.6	25.5	7.0	238.0	93.8
2.0	68.0	26.8	7.1	241.4	95.1
2.1	71.4	28.1	7.2	244.8	96.5
2.2	74.8	29.5	7.3	248.2	97.8
2.3	78.2	30.8	7.4	251.6	99.2
2.4	81.6	32.2	7.5	255.0	100.5
2.5	85.0	33.5	7.6	258.4	101.8
2.6	88.4	34.8	7.7	261.8	103.2
2.7	91.8	36.2	7.8	265.2	104.5
2.8	95.2	37.5	7.9	268.6	105.9
2.9	98.6	38.9	8.0	272.0	107.2
3.0	102.0	40.2	8.1	275.4	108.5
3.1	105.4	41.5	8.2	278.8	109.9
3.2	108.8	42.9	8.3	282.2	111.2
3.3	112.2	44.2	8.4	285.6	112.6
3.4	115.6	45.6	8.5	289.0	113.9
3.5	119.0	46.9	8.6	292.4	115.2
3.6	122.4	48.2	8.7	295.8	116.6
3.7	125.8	49.6	8.8	299.2	117.9
3.8	129.2	50.9	8.9	302.6	119.3
3.9	132.6	52.3	9.0	306.0	120.6
4.0	136.0	53.6	9.1	309.4	121.9
4.1	139.4	54.9	9.2	312.8	123.3
4.2	142.8	56.3	9.3	316.2	124.6
4.3	146.2	57.6	9.4	319.6	126.0
4.4	149.6	59.0	9.5	323.0	127.3
4.5	153.0	60.3	9.6	326.4	128.6
4.6	156.4	61.6	9.7	329.8	130.0
4.7	159.8	63.0	9.8	333.2	131.3
4.8	163.2	64.3	9.9	336.6	132.7
4.9	166.6	65.7			
5.0	170.0	67.0			

Volume Setup

Volume Setup

[Volume] is selected on the Setup menu screen.

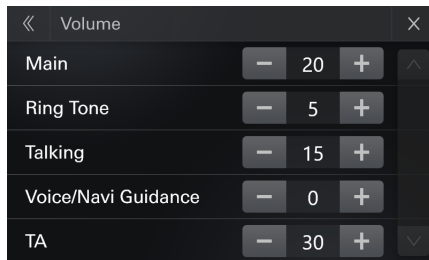

Setting item:

Main.Ring Vol.Talking.Voice/Navi Guidance.TA

Setting contents:

Main :01 to 35(Initial setting: 10)

Ring Vol :01 to 35(Initial setting: 18)

Talking :01 to 35(Initial setting: 18)

Voice/Navi Guidance :01 to 35(Initial setting: 18)

TA :01 to 35(Initial setting: 10)

Bluetooth Setup

[Bluetooth] is selected on the Setup menu screen.

Setting item:

Bluetooth

Setting contents:

Bluetooth,Devices List, Devices Info,

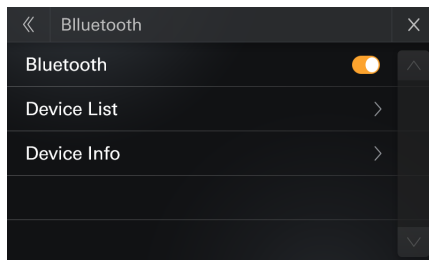

Bluetooth

- You can turn Bluetooth on or off

Device List

[Devices] is selected on the Bluetooth Setup Menu screen.

You can register and set up Bluetooth compatible devices.

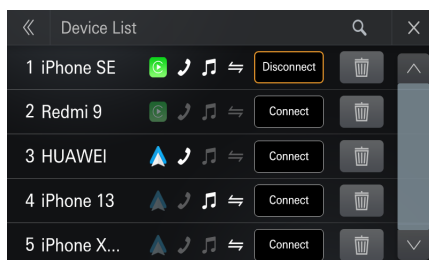

Pairing the Bluetooth Device

- 1 Touch [Q] to enter [Search] screen to search for Devices.
- 2 Select a device and follow the on-screen prompts to connect devices
- 3 Screen prompts 6 character Numeric passkey to pair
When the device registration is complete, a message appears and the device returns to [Device List].
 - The Bluetooth registration process differs depending on the device version and SSP (Simple Secure Pairing). If a 4 or 6 character Numeric Comparison appears on this system, enter the Numeric Comparison on the Bluetooth device.
 - If a 6 character Passkey appears on this system, make sure the same passkey is displayed on the Bluetooth device, and follow the screen.

Fast pairing the Bluetooth Device

Select one of 5 paired Bluetooth compatible devices that you previously registered.

- 1 Touch [Connect] on the Bluetooth Setup Menu screen.

Deleting a Bluetooth Device from the list

You can delete the information of a previously connected Bluetooth compatible device.

- 1 Touch [] on the Bluetooth Setup Menu screen.
- 2 Touch [Yes].
 - Touching [No] will cancel the setting.

Searching for a Bluetooth Device

Setting item:

Search

- 1 Touch [Q] on the device list interface in Bluetooth Setup.
The Bluetooth devices can be searched are displayed in a list.
- 2 Touch the device you want to connect from the list.
You can register up to 5 Bluetooth compatible mobile phones.
- 3 When the device registration is complete, a message appears and the device returns to [Device List].
 - Connect to new Bluetooth compatible device when there are 5 paired devices registered , the system will delete the last paired device automatically

Displaying Bluetooth Information

[Info] is selected on the Bluetooth Setup Menu screen.

You can display the Bluetooth device name and device address of this unit.

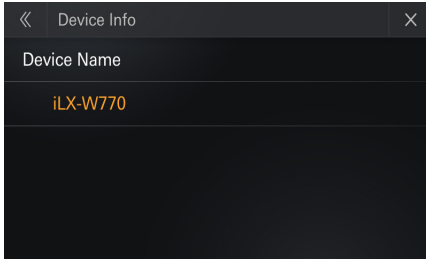

Auto Connection

When the ACC is turned ON, the Bluetooth Hands-Free device is automatically connected. After connecting to the Hands-Free device, the Bluetooth Audio device is also connected automatically.

Downloading the Phonebook

If PBAP is connected, you can download the phonebook from the device.

- *When the device is disconnected, the downloaded phonebook is not shown.*

Wi-Fi® Setup

[Wi-Fi] is selected on the Setup menu screen.

Setting item:

Wi-Fi

Setting contents:

Wi-Fi, Device Information, Password, Reset Password

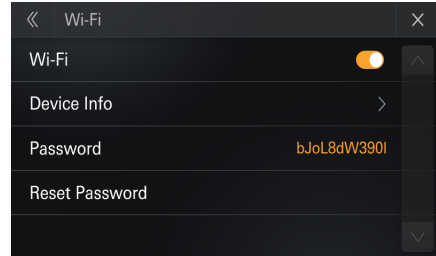

Wi-Fi

- You can turn Wi-Fi on or off

Reset Password

- You can reset the Wi-Fi password

Device Info

It displays the Network Name and MAC Address of Wi-Fi.

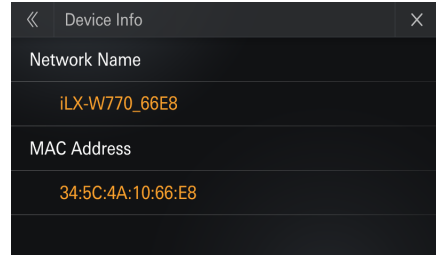

About Wi-Fi

The unit just supports 5G Hz Wi-Fi, and supports to connect the smart mobile phone while using the Apple CarPlay or Android Auto.

Rear Camera Setup

[Rear Camera] is selected on the Setup Menu screen.
You can set up items related to the Rear Camera.

Setting item:
Rear Camera

Setting contents:
Camera, Mute While Backing Up, Interrupt(Power OFF), Parking Guide Adjust, Video Setup

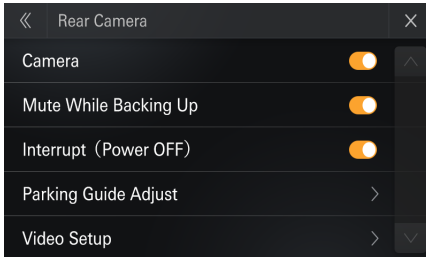

Camera

Setting item:
Camera

Setting contents:
Off, On (Initial setting),

- The rear camera initial setting is ON, when you turn off the camera, you cannot open and setup the camera.

Mute While Backing Up

Setting item:
Mute While Backing Up

Setting contents:
Off (Initial setting), On,

Interrupt (Power OFF)

Setting item:
Interrupt(Power OFF)

Setting contents:
Off, On (Initial setting)

- ON setting >When the power of the ILX-W770 is OFF, the camera image is interrupt.
- OFF setting>When the power of the ILX-W770 is ON, the camera image is not interrupt.

Parking Guide Adjust Setup

You can adjust the camera guide position.

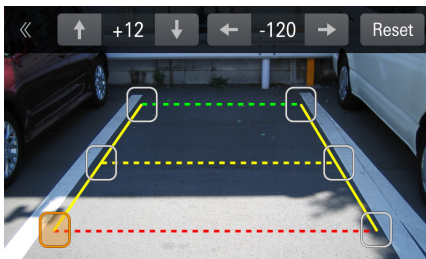

Setting item:
Parking Guide Adjust

Setting contents:
Touch the icon you want to move.

- 1 Touch the icon you want to move.
- 2 Touch [↑][↓][←][→] to move the icon.
Touching [Reset] clears adjustments and returns to the setting before guide line alteration.
- 3 Touch [↩] to complete the adjustment and return to the previous screen.

Video Setup

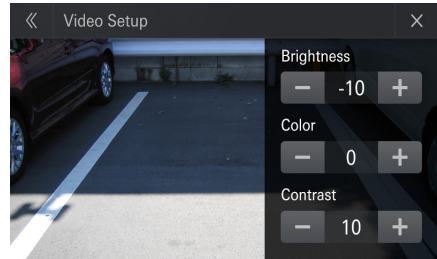

Adjusting Brightness

Setting item:
Brightness

Setting contents:
-10 to 10 (Initial setting: 0)

- You can adjust the brightness of USB Video and reverse video between MIN(-10)and MAX(10)

Adjusting Color of Display

Setting item:
Colors

Setting contents:
-10 to 10 (Initial setting: 0)

- You can adjust the color of USB Video and reverse video between MIN(-10)and MAX(10)

Adjusting Display Contrast

Setting item:
Contrast

Setting contents:
-10 to 10 (Initial setting: 0)

- You can adjust the Contrast of USB Video and reverse video between MIN(-10)and MAX(10)

2nd Camera Setup

[2nd Camera] is selected on the Setup Menu screen.
You can set up items related to the 2nd Camera.

Setting item:

2nd Camera

Setting contents:

2nd camera, Guide Line Adjust, Video Setup

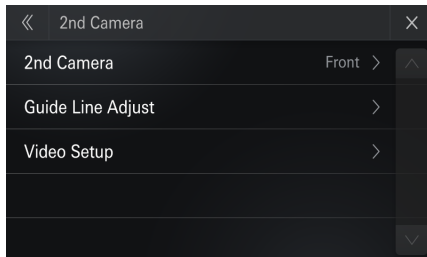

2nd Camera

Setting item:

2nd Camera

Setting contents:

Off, Front, Side(left/right), Other

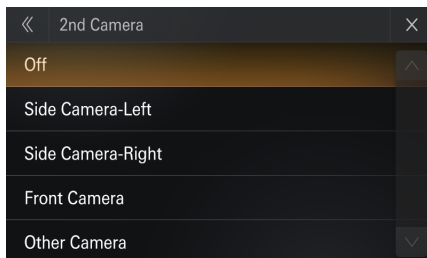

Guide Line Adjust

You can adjust the selection camera guide position.

Front Camera

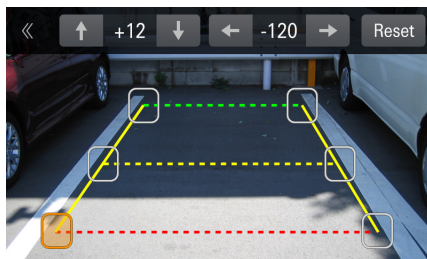

Left camera

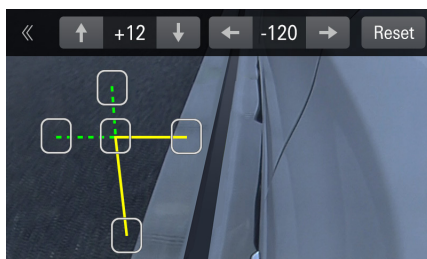

Right Camera

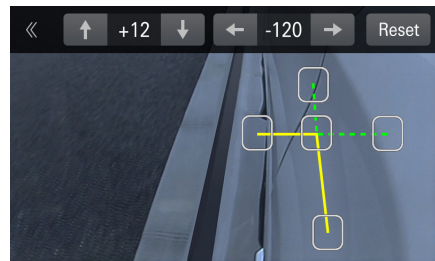

- If the 2nd camera was set to Other camera, [Guide Line Adjust] is unavailable.

Video Setup

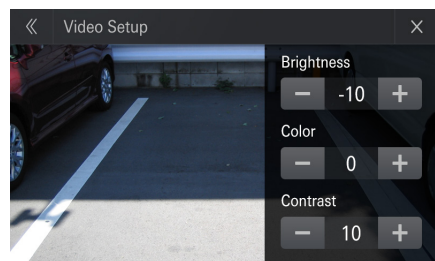

Adjusting Brightness

Setting item:

Brightness

Setting contents:

-10 to 10 (Initial setting: 0)

- You can adjust the brightness of USB Video and reverse video between MIN(-10) and MAX(10)

Adjusting Color of Display

Setting item:

Colors

Setting contents:

-10 to 10 (Initial setting: 0)

- You can adjust the color of USB Video and reverse video between MIN(-10) and MAX(10)

Adjusting Display Contrast

Setting item:

Contrast

Setting contents:

-10 to 10 (Initial setting: 0)

- You can adjust the Contrast of USB Video and reverse video between MIN(-10) and MAX(10)

Lighting Link ON/OFF

[Lighting link] is selected on the Setup menu screen.

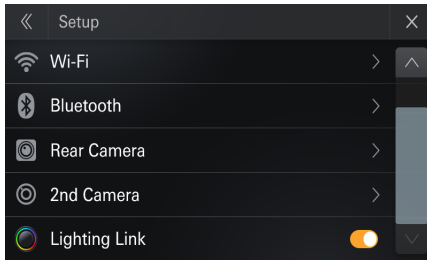

Setting item:

Lighting Link

Setting contents

On:

Lighting link icon displayed on sound boost screen

Off:

The Lighting link icon on the sound boost screen is not displayed



Distance guidance mark

The distance guides represent the ground level distance from the rear bumper. It is difficult to accurately estimate the distance to objects above ground level.

In the following example, the distance to A is 0.5 m and the distance to B is 1 m.

<Screen>

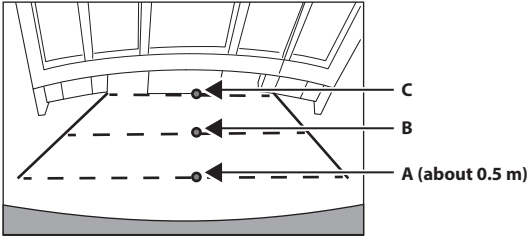

<Positions of A, B and C>

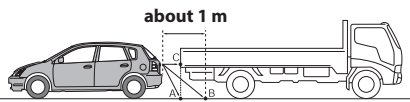

In the screen, according to the distance guidance marks, the truck seems to be parked about 1 m away (at the position B). In actual fact, however, if you reversed to position A, you would collide with the truck.

In the screen, positions A, B and C seem to be located in order of proximity. However, in actual fact, the position A and C are the same distance, and B is farther away than positions A and C.

- The car width extension mark represents the distance to the road surface. The distance to an object on the road is not accurately represented by the guides.

Error between the screen and the actual road surface

In the following conditions, errors are produced between the screen guidance and the actual road surface. (The illustrations represent a case when the camera is installed in the standard position.)

When there is a steep upward slope behind the car (example)

<Screen>

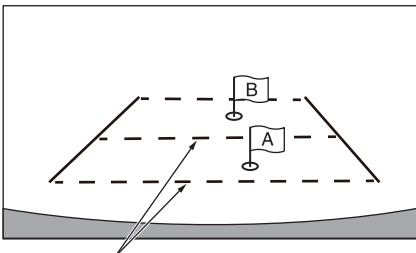

Distance guidance marks

<Situation of the car>

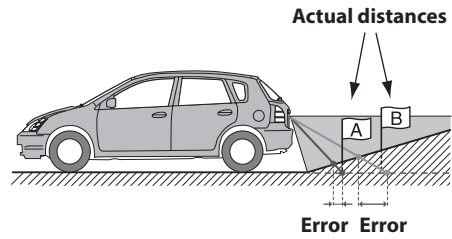

The distance guidance mark represents the distance to a flat road surface. Therefore in the case of an upward slope behind the car, the distance guides are displayed closer to the rear bumper than the actual distance. For example, if there is an obstacle on the upward slope, it may appear farther away than its actual position.

Also, an error may occur between the guidance and the actual path of the car on the road surface.

When there is a steep downward slope behind the car (example)

<Screen>

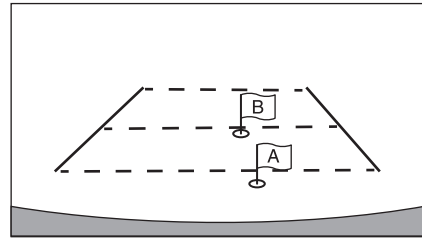

<Situation of the car>

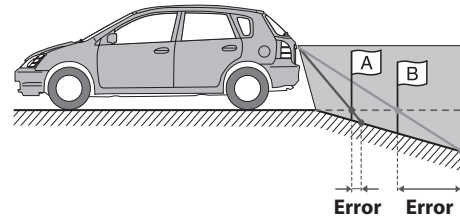

In the case of a downward slope behind the car, the distance guides are displayed farther from the rear bumper than the actual distance.

If there is an obstacle on the downward slope, it seems closer than its actual position.

Also, an error may occur between the guidance and the actual path of the car on the road surface.

Information

About the Supported Formats

⚠ CAUTION

Except for private use, duplicating audio data or distributing, transferring, or copying it, whether for free or for a fee, without permission of the copyright holder is strictly prohibited by the Copyright Act and by international treaty.

About Audio Format

Method for creating WAVE/WMA/AAC/AC3/MPEG/Ogg/FLAC/APE (USB Flash drive) files

Audio data is compressed using software with WAVE/WMA/AAC/AC3/MPEG/Ogg/FLAC/APE (USB Flash drive) codecs. For details on creating WAVE/WMA/AAC/AC3/MPEG/Ogg/FLAC/APE (USB Flash drive) files, refer to the user's manual for that software. WAVE/WMA/AAC/AC3/MPEG/Ogg/FLAC/APE (USB Flash drive) files that are playable on this device have the file extensions.

WAVE:.wav
WMA:.wma,.asf
AAC:.aac
AC3:.ac3,.ec3
MPEG:.mp1,.mp2,.mpa,.mp3,.mp4,.m4a
Ogg:.ogg
FLAC:.flac
APE:.ape

WMA is not supported for the following files, Windows Media Audio Professional, Windows Media Audio 10 std or Windows Media Audio 10 Pro Lossless.

There are many different versions of the AAC format. Confirm that the software being used conforms to the acceptable formats listed above. It's possible that the format may be unplayable even though the extension is valid. Playback of AAC files encoded by iTunes is supported.

WAVE (USB Flash drive)

Filename : .wav
Container: Waveform Audio File Format(base on RIFF)
Audio Coding: LPCM,IMA-ADPCM

WMA (USB Flash drive)

Filename : .wma,.asf
Container: Advanced Systems Format(ASF)
Audio Coding: WMA STD

* Support object:
Content Description Object: only
Title,Artist

AAC (USB Flash drive)

Filename : .aac
Container: Audio Data Transport Stream (ADTS)
Audio Coding: AAC-LC/HE-AAC

AC3 (USB Flash drive)

Filename : .ac3,.ec3
Container: AC3 bit streams
Audio Coding: AC3

Container: Enhanced AC3 Bit Stream
Audio Coding: E-AC3

MPEG (USB Flash drive)

Filename : .mp1
Container: MPEG PS
Audio Coding: MP1

Filename: .mp2,.mpa
Container: MPEG PS
Audio Coding: MP2

Filename : .mp3
Container: MPEG PS
Audio Coding: MP3

* Support Tag:ID3V1 ID3v2.3 : only
TPE1, TALB, TCON, TIT2, TYER

Filename : .mp4,.m4a
Container: MP4 File Format
Audio Coding: AAC-LC,HE-AAC

OGG (USB Flash drive)

Filename : .ogg
Container: Ogg
Audio Coding: Vorbis

FLAC (USB Flash drive)

Filename : .flac
Container: FLAC
Audio Coding: FLAC

APE (USB Flash drive)

Filename : .ape
Container: APE (Monkey's Audio Lossless Audio File)
Audio Coding: Monkey's Audio

About Video Format

Files that are playable on this device have the file extensions.

AVI: .avi
MPEG 1/2: .mpg,.mpeg,.vob(with.info),.dat
MPEG4: .mp4,.mpeg4,.m4v
Flash:.flv,.swf
QuickTime:.mov,.qt
Matroska Video:.mkv
TS Stream:.ts,.tp,.trp,.m2ts <BD>,.MTS<AVCHD>
3GP:.3gp
WMV:.wmv
ASF:.asf

Format: AVI

Filename : .avi
Video Coding: MPEG-4 SP/ASP(FMP4), Sorenson H.263(FLV1), H.264, Xvid, WMV 9 / VC - 1, MJPEG (Maximum resolution:1280x720), MPEG-2 Video, MPEG-1 Video
Audio Coding: MP3, AC3, WMA St, LPCM /ADPCM

Format: MPEG 1/2

File Name:.mpg .mpeg
Video Coding: MPEG-1 Video, MPEG-2 Video, H.264
Audio Coding: MP1 / MP2 / MP3, AAC-LC, AC3, LPCM

File Name: vob (with.info)

Video Coding: MPEG-2 Video Main
Audio Coding: MP1 / MP2 / MP3, AC3, LPCM

File Name:.dat

Video Coding: MPEG-1 Video
Audio Coding: MPEG-1 Audio Layer II

Format: MPEG4

File Name:.mp4,.mpeg4

Video Coding: MPEG-2 Video, MPEG-4 SP/ASP, H.264, MJPEG (Maximum resolution:1280x720)
Audio Coding: MP3, AAC-LC/HE-AAC, AC3, LPCM

File Name:.m4v

Video Coding: H.264
Audio Coding: AAC-LC / HE-AAC, AC3

Format: Flash**File Name:.flv**

Video Coding: Sorenson H.263(FLV1), H.264

Audio Coding: MP3, AAC-LC, ADPCM

File Name:.swf

Video Coding: Sorenson H.263(FLV1), H.264

Audio Coding: MP3, ADPCM

Format: QuickTime**File Name:.mov .qt**

Video Coding: MPEG-4 SP/ASP, H.264,

MJPEG (MJPEG(Maximum resolution:1280x720))

Audio Coding: MP3, AAC-LC / HE-AAC, LPCM

Format: Matroska Video

File Name:.mkv

Video Coding: MPEG-1 Video, MPEG-2 Video, MPEG-4 SP/ASP, H.264,

Xvid, WMV9 / VC-1

Audio Coding: MP3, AC3, LPCM, AAC-LC / HE-AAC

Format: TS Stream**File Name:.ts .tp .trp**

Video Coding: MPEG-1 Video, MPEG-2 Video, MPEG-4 H.264,

WMV 9 / VC-1

Audio Coding: MP1 / MP2 / MP3, AC3, AAC-LC / HE-AAC

File Name:.m2ts <BD>

Video Coding: MPEG-2 Video, H.264, WMV 9 / VC-1

Audio Coding: AC3, LPCM

File Name:..MTS <AVCHD>

Video Coding: H.264

Audio Coding: AC3, LPCM

Format: 3GP**File Name:.3gp**

Video Coding: MPEG-4 SP/ASP, H.263, H.264

Audio Coding: ACC-LC / HE-AAC

Format: WMV**File Name:.wmv**

Video Coding: VC-1

Audio Coding: WMA Std

Format: ASF**File Name:.asf**

Video Coding: VC-1

Audio Coding: WMA Std

Maximum files numbers of folders:

USB Flash drive (Audio/Video/Photo):999

iPod:No folder, only a playlist is available with up to 100 files

Android MSC: Same as USB

Maximum folders numbers of device:

USB Flash drive(Audio/Video/Photo):1000

iPod:No folder, up to 100 playlists

Android MSC: Same as USB

• Supports a maximum of 256 GB USB**• Largest playable file size:**

Audio files :4GB

Video files: 4 GB

Photo files: 10K-6M

Playback may not be performed if a disc exceeds the limitations described above.

Media supported

The media that this device can play back a USB flash drive.

Corresponding File Systems

This device supports FAT 16/32, NTFS.

The maximum nested folder depth is 8 (including the root directory).

Order/Search of files

Display and sort according to the head character

Display in the order of 1 -> 2 -> 3 below.

0: Folder :When there are folders, the folders are displayed ahead of the files

1: Number (represented by "#" on the Right Search Bar)

2: English Alphabet

3: Shorting order of Unicode

Right Search Bar (order of list)

1: Number (represented by "#" on the Right Search Bar)

2: English Alphabet

- Search only the files with numeric or English alphabetic headers

Terminology**Bit rate**

This is the "sound" compression rate specified for encoding. The higher the bit rate, the higher the sound quality, but also the larger the files.

Sampling rate

This value shows how many times per second the data is sampled (recorded). For example, music CDs use a sampling rate of 44.1 kHz, so the sound is sampled (recorded) 44,100 times per second. The higher the sampling rate, the higher the sound quality, but also the larger the volume of data.

Encoding

Converting music CDs, WAVE (AIFF) files, and other sound files into the specified audio compression format.

Tag

Song information such as track titles, artist names, album names, etc., written into MP3/WMA/AAC/FLAC/WAVE/Ogg/APE (USB flash drive) files.

Root folder

The root folder (or root directory) is found at the top of the file system. The root folder contains all folders and files. It is created automatically for all burned discs.

About Photo Format**Format: Jpg.jpeg**

Resolution ratio: Maximum 4096 x 4096, minimum 32x32

Format:Png

Resolution ratio: Maximum 576 x 720 minimum 32x32

Format:bmp

Resolution ratio: Maximum 936 x 1920 minimum 32x32

ID3 tags/WMA tags

If the music supports ID3 tag and track title ,music title, author, album name and album cover are to be displayed.
If there is no track title , "No Name" will be displayed.
If there is no album name, the name of the folder will be displayed, if the song name is not recognized, it will be garbled, if there is no album cover, it will not be displayed.

Playing back file

- The files are prepared, then written to a USB flash drive.
- Connect iPod/Android MSC

Maximum numbers of playable files/folders**Maximum files numbers of device:**

USB Flash drive(Audio/Video/):9999

USB Flash drive(Photo):999

iPod:2000

Android MSC: Same as USB

In Case of Difficulty

If you encounter a problem, please turn the power off, then on again. If the unit is still not functioning normally, please review the items in the following checklist. This guide will help you isolate the problem if the unit is at fault. Otherwise, make sure the rest of your system is properly connected, or then consult your authorized Alpine dealer.

Basic

No function or display.

- Vehicle's ignition is off.
 - If connected according to the instructions, the unit will not operate with the vehicle's ignition off.
- Improper power lead connections.
 - Check power lead connections.
- Blown fuse.
 - Check the fuse on the battery lead of the unit; replace with the proper value if necessary.

No sound or unnatural sound.

- Incorrect setting of volume/balance/fader controls.
 - Readjust the controls.
- Connections are not properly or securely made.
 - Check the connections and firmly connect.

Screen not displayed.

- Brightness/Contrast control is set at the minimum position.
 - Adjust the Brightness/Contrast control.
- Temperature in the vehicle is too low.
 - Increase the vehicle's interior temperature to operation temperature range.
- Connections to the Auxiliary Device are not securely made.
 - Check the connections and firmly connect.
- The Parking Brake Lead is not connected.
- The Parking Brake is not engaged.
 - Connect the Parking Brake Lead, then engage the Parking Brake.

Movement of displayed picture is abnormal.

- Temperature in the vehicle is too high.
 - Allow the vehicle's interior temperature to cool.

Radio

Unable to receive stations.

- No antenna, or open connection in the antenna cable.
 - Make sure the antenna is properly connected; replace the antenna or cable if necessary.

Unable to tune stations in the seek mode.

- You are in a weak signal area.
 - Change the radio frequency manually.
- If the area you are in is a primary signal area, the antenna may not be grounded and connected properly.
 - Check your antenna connections; make sure the antenna is properly grounded at its mounting location.
- The antenna may not be the proper length.
 - Make sure the antenna is fully extended; if broken, replace the antenna with a new one.

Broadcast is noisy.

- The antenna is not the proper length.
 - Extend the antenna fully; replace it if it is broken.
- The antenna is poorly grounded.
 - Make sure the antenna is grounded properly at its mounting location.
- The station signal is weak and noisy.
 - If above solution does not work, tune in another station.

USB Audio

Unit does not operate.

- Condensation.
 - Wait a while (about 1 hour) for the condensation to dry.

Picture is unclear or noisy.

- Vehicle's battery power is weak.
 - Check the battery power and wiring.
(The unit may malfunction if the battery power is under 11 volts with a load applied.)

If this Message Appears

Various messages are displayed on the screen during operation. In addition to the messages telling you the current status or providing guidance for the next operation, there are also the following error messages. If one of these error messages is displayed, carefully follow the instructions in the solution column.

System

ATTENTION!

Viewing of front seat video source while driving is strictly prohibited.

- A setup operation, etc., was carried out while the vehicle was running.
 - Move the vehicle to a safe location, stop, and engage the parking brake, then carry out this operation.
-

Audio/Visual

This content cannot be played.

- Unsupported content .
 - Change to play supported contents type.

This device is not supported./Unsupported USB device

- Unsupported device.
 - Change to play supported USB device.

Device No Response.

- No response from the device.

USB Hub is not supported.

- The USB hub is not supported.

No Audio.

- There is no audio data in the current video file.
 - Download a video file with audio data in it .

Audio format not supported

- Not supported audio format.
 - Download supported audio format to USB flash drive.

Audio trick not supported/Video Trick not supported

- Prompts fast forwarding / reversing or jumping on current audio /video is not supported.
 - Change the current audio /video format.

Video other warning

- Prompts unexpected warning message.
 - Change to play other video.

Video format not supported

- Unsupported video format.
 - Change to play the supported video format.

Video other error

- Unknown error.
 - Change to play other video.

No Artist (/ No Song / No album)

- There are no tag-info in the USB Audio / iPod Audio.
 - Change to play audio-file with tag-info

No Date

- There are no data in the USB flash drive.
 - Download data to the USB flash drive and connect to this unit.
-

SiriusXM

Check Tuner

- The SiriusXM Tuner is disconnected or the unit is having trouble communicating with the Tuner.
 - Connect the Tuner or check the Tuner connection to the back of the unit.

Check Antenna

- The SiriusXM Satellite Radio antenna or cable is either damaged or not connected correctly to the SiriusXM Tuner.
 - Check that the SiriusXM antenna cable is connected to the SiriusXM Tuner and check that the antenna cable is not kinked or otherwise damaged. Replace the antenna if necessary.
 - SiriusXM products are available at your local car audio retailer or online at www.shop.siriusxm.com.

No Signal

- The SiriusXM satellite signal is too weak at the current location.
 - Move the vehicle to a location with a clear view of the southern sky.
 - Make sure the Satellite Radio antenna is properly mounted and not obstructed by metal objects.

Channel [xxx] Not Subscribed

Call SiriusXM to Subscribe

- The active channel has become unsubscribed or the requested channel is not available in your subscription package.
 - In the USA, you can activate online or by calling SiriusXM Listener care:
 - Visit www.siriusxm.com/activatenow
 - Call SiriusXM Listener Care at 1-866-635-2349
 - For Canadian Subscriptions, please contact:
 - Visit www.siriusxm.ca/activate
 - Call SiriusXM Customer Care at 1-888-539-7474
 - The unit will revert to the previously selected channel or to channel 1 automatically.

Channel [xxx] Not Available

- The active channel is no longer in the SiriusXM channel lineup or the user has entered an invalid channel number.
 - Visit www.siriusxm.com for information on the current channel lineup.
- The unit will revert to the previous channel or to channel 1 automatically.

Subscription Updated

Press Enter to Continue

- Your subscription has been updated.
 - Touch [Enter] to clear this message.

Password modified successfully

- Password entered incorrectly.
 - Enter the correct password
-

Bluetooth

No Bluetooth device were found

- The Bluetooth audio device was not connected correctly.
 - Check the settings for the unit and the Bluetooth audio device and reconnect
-

Phone

Empty

- The phone book is empty.

Phone book access is not authorized

- The phone book download is not supported.
 - On Enable phone book permission.

Handsfree device is not connected

- Hands-Free Profile is not connected.
 - Connect Hands- Free Profile .
-

AUX

Picture off for your safety.

- While the vehicle is moving.
 - Parking.
-

HOME

No devices available connect an Android Phone with USB cable.

- When Android Auto is not connected , touch Android Auto icon , this message is displayed .

Caution! AMP Overload.

- When two volume cables are connected ,this message is displayed.
 - Take apart the volume cable and reboot the unit.

Caution! USB Overcurrent.

- Prompts USB Overcurrent
 - Remove the USB and reboot the unit
-

Apple CarPlay

Please attach the GPS antenna in order to use Apple CarPlay over wireless.

- The GPS antenna is disconnected or bad connection.
 - Connect the GPS antenna.
-

Setup

Data check error..

- Upgrade firmware check error
 - Exit upgrade progress

There is no photo in this device.

- No photo in this device
 - Download the photo with supported format ((JPG,JPEG,PNG,BMP))to this device
-

Specifications

MONITOR SECTION

Screen Size	6.75"
LCD Type	Normally white, Transmissive
Operation System	a-Si TFT active matrix
Number of Picture Elements	1,152,000 pcs. (800 × 480 × 3(RGB))
Effective Number of Picture Elements	99% or more
Illumination System	LED

FM TUNER SECTION

Tuning Range	87.7 – 107.9 MHz
Mono Usable Sensitivity	< 9 dBu (75 ohms)
50 dB Quieting Sensitivity	< 5 dBu (75 ohms)
Signal-to-Noise Ratio	65 dB
Stereo Separation	35 dB

AM TUNER SECTION

Tuning Range	530 – 1710 kHz
Usable Sensitivity	34 dBu

USB SECTION

USB requirements	USB 2.0
Max. Power Consumption	1,500 mA (CDP Support)
USB Class	USB (Play From Device)/ USB (Mass Storage Class)
File System	FAT16/32, NTFS
Number of Channels	2-Channels (Stereo)
Frequency Response*1	17 – 20,000 Hz (±1 dB)
Total Harmonic Distortion	0.05% (at 1 kHz)
Dynamic Range	90 dB (at 1 kHz)
Signal-to-Noise Ratio	85 dB
Channel Separation	75 dB (at 1 kHz)

*1 Frequency response may differ depending on the encoder software/bit rate.

Bluetooth SECTION

Bluetooth Specification	Bluetooth V5.0
Output Power Profile	< +4dBm Ave. (Power class 2) HFP (Hands-Free Profile) PBAP (Phone Book Access Profile) A2DP (Advanced Audio Distribution Profile) AVRCP (Audio/Video Remote Control Profile)

Wi-Fi SECTION

Wi-Fi Specification	Support IEEE 802.11a/n/ac
Model	Access point(AP)
Band	5G Hz

GENERAL

Power Requirement	14.4 V DC (10.8 – 16.0 V allowable)
Operating temperature	-4°F to +140°F (-20°C to + 60°C)
Power Output	16 W RMS × 4 ²
*2 Primary amplifier ratings per CEA-2006 Standard	
• Power output: measured at 4 Ohms and ≤ 1% THD+N	
• S/N: 80 dBA (reference: 1 W into 4 Ohms)	
Weight	0.9 kg
Audio output level	
Preout (Front, Rear):	4V/10k ohms (max.)
Preout (Subwoofer):	4V/10k ohms (max.)

CHASSIS SIZE

Width	178 mm
Height	100 mm
Depth	68 mm

- Due to continuous product improvement, specifications and design are subject to change without notice.
- The LCD panel is manufactured using an extremely high precision manufacturing technology. Its effective pixel ratio is over 99.99%. This means that there is a possibility that 0.01% of the pixels could be either always ON or OFF

Installation and Connections

Before installing or connecting the unit, please read the following and pages 5 to 8 of this manual thoroughly for proper use.

WARNING

KEEP SMALL OBJECTS SUCH AS SCREWS OUT OF THE REACH OF CHILDREN.

Swallowing them may result in serious injury. If swallowed, consult a physician immediately.

MAKE THE CORRECT CONNECTIONS.

Failure to make the proper connections may result in fire or product damage.

USE ONLY IN CARS WITH A 12 VOLT NEGATIVE GROUND.

(Check with your dealer if you are not sure.) Failure to do so may result in fire, etc.

BEFORE WIRING, DISCONNECT THE CABLE FROM THE NEGATIVE BATTERY TERMINAL.

Failure to do so may result in electric shock or injury due to electrical shorts.

DO NOT ALLOW CABLES TO BECOME ENTANGLED IN SURROUNDING OBJECTS.

Arrange wiring and cables in compliance with the manual to prevent obstructions when driving. Cables or wiring that obstruct or hang up on places such as the steering wheel, gear lever, brake pedals, etc. can be extremely hazardous.

DO NOT SPLICE INTO ELECTRICAL CABLES.

Never cut away cable insulation to supply power to other equipment. Doing so will exceed the current carrying capacity of the wire and result in fire or electric shock.

DO NOT DAMAGE PIPE OR WIRING WHEN DRILLING HOLES.

When drilling holes in the chassis for installation, take precautions so as not to contact, damage or obstruct pipes, fuel lines, tanks or electrical wiring. Failure to take such precautions may result in fire.

DO NOT USE BOLTS OR NUTS IN THE BRAKE OR STEERING SYSTEMS TO MAKE GROUND CONNECTIONS.

Bolts or nuts used for the brake or steering systems (or any other safety-related system), or tanks should NEVER be used for installations or ground connections. Using such parts could disable control of the vehicle and cause fire etc.

DO NOT INSTALL IN LOCATIONS WHICH MIGHT HINDER VEHICLE OPERATION, SUCH AS THE STEERING WHEEL OR GEARSHIFT.

Doing so may obstruct forward vision or hamper movement etc. and results in serious accident.

CAUTION

HAVE THE WIRING AND INSTALLATION DONE BY EXPERTS.

The wiring and installation of this unit requires special technical skill and experience. To ensure safety, always contact the dealer where you purchased this product to have the work done.

USE SPECIFIED ACCESSORY PARTS AND INSTALL THEM SECURELY.

Be sure to use only the specified accessory parts. Use of other than designated parts may damage this unit internally or may not securely install the unit in place. This may cause parts to become loose resulting in hazards or product failure.

ARRANGE THE WIRING SO IT IS NOT CRIMPED OR PINCHED BY A SHARP METAL EDGE.

Route the cables and wiring away from moving parts (like the seat rails) or sharp or pointed edges. This will prevent crimping and damage to the wiring. If wiring passes through a hole in metal, use a rubber grommet to prevent the wire's insulation from being cut by the metal edge of the hole.

DO NOT INSTALL IN LOCATIONS WITH HIGH MOISTURE OR DUST.

Avoid installing the unit in locations with high incidence of moisture or dust. Moisture or dust that penetrates into this unit may result in product failure.

Precautions

- Be sure to disconnect the cable from the (-) battery post before installing your unit. This will reduce any chance of damage to the unit in case of a short-circuit.
- Be sure to connect the color coded leads according to the diagram. Incorrect connections may cause the unit to malfunction or damage to the vehicle's electrical system.
- When making connections to the vehicle's electrical system, be aware of the factory installed components (e.g. on-board computer). Do not tap into these leads to provide power for this unit. When connecting the unit to the fuse box, make sure the fuse for the intended circuit of the unit has the appropriate amperage. When in doubt, consult your Alpine dealer.
- The unit uses female RCA-type jacks for connection to other units (e.g. amplifier) having RCA connectors. You may need an adaptor to connect other units. If so, please contact your authorized Alpine dealer for assistance.
- Be sure to connect the speaker (-) leads to the speaker (-) terminal. Never connect left and right channel speaker cables to each other or to the vehicle body.

Accessory List

Main unit.....	1
Power cable.....	1
RCA cable.....	1
GPS antenna	1set
Microphone	1
USB extension cable	1
Screw.....	4
Countersunk screw	4
Quick Reference Guidance	1
Card note1	1
Card note2.....	1

Installation

CAUTION

- Do not cover the heat sink to block air circulation, as heat can accumulate in the chamber and cause a fire.

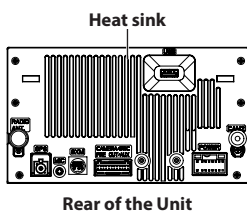

Caution concerning the installation location

Angle of installation

Install at an angle between horizontal and 30°. Note that installing at an angle outside of this range will result in a loss of performance and possibly damage.

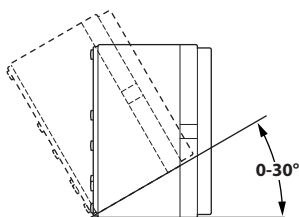

Mounting the Microphone

For safe use, make sure of the following:

- Location is stable and firm.
- Does not interfere with safety equipment.
- Driver's view and operations are not obstructed.
- Microphone is located where the driver's voice can be easily picked up (for example, on the sun visor).

When you speak into the microphone, you should not have to change your driving posture. This may cause a distraction, taking your attention away from safely driving your vehicle. Carefully consider direction and distance while mounting the microphone. Confirm that the driver's voice can be easily picked up at the selected location.

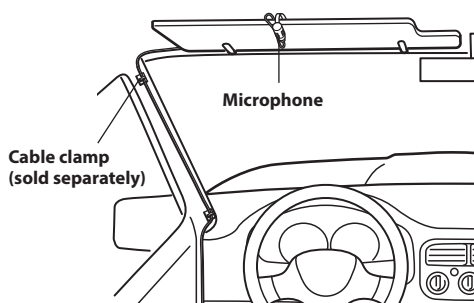

Installation example using the Original Mounting Bracket

- Mount the original mounting bracket to the unit using the supplied screws.

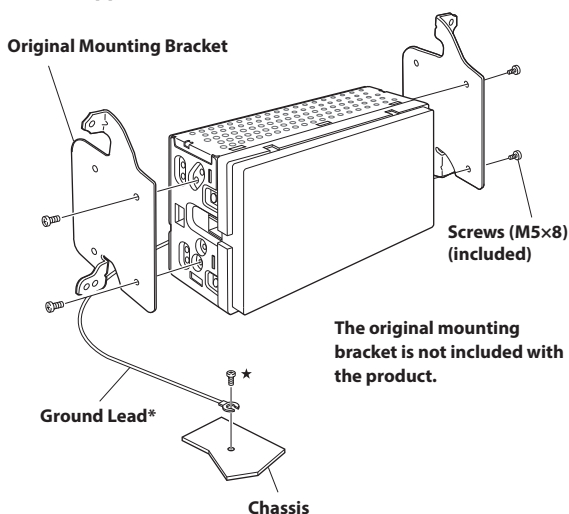

The original mounting bracket is not included with the product.

- Connect all other leads of the unit according to details described in the "Connections" (page 52).

- Mount the unit in a car.

- To securely connect the ground lead, use an already installed screw on a metal part of the vehicle (marked (★)) or a clean, bare metal spot on the vehicle's chassis.
- Fix the cables carefully. Do not damage them by mounting them into movable parts, such as the seat rail, or by locating them against sharp or pointed edges.

- Reattach the removed vehicle parts (panels, etc.) or other aftermarket dash kit back onto the vehicle.

Connections

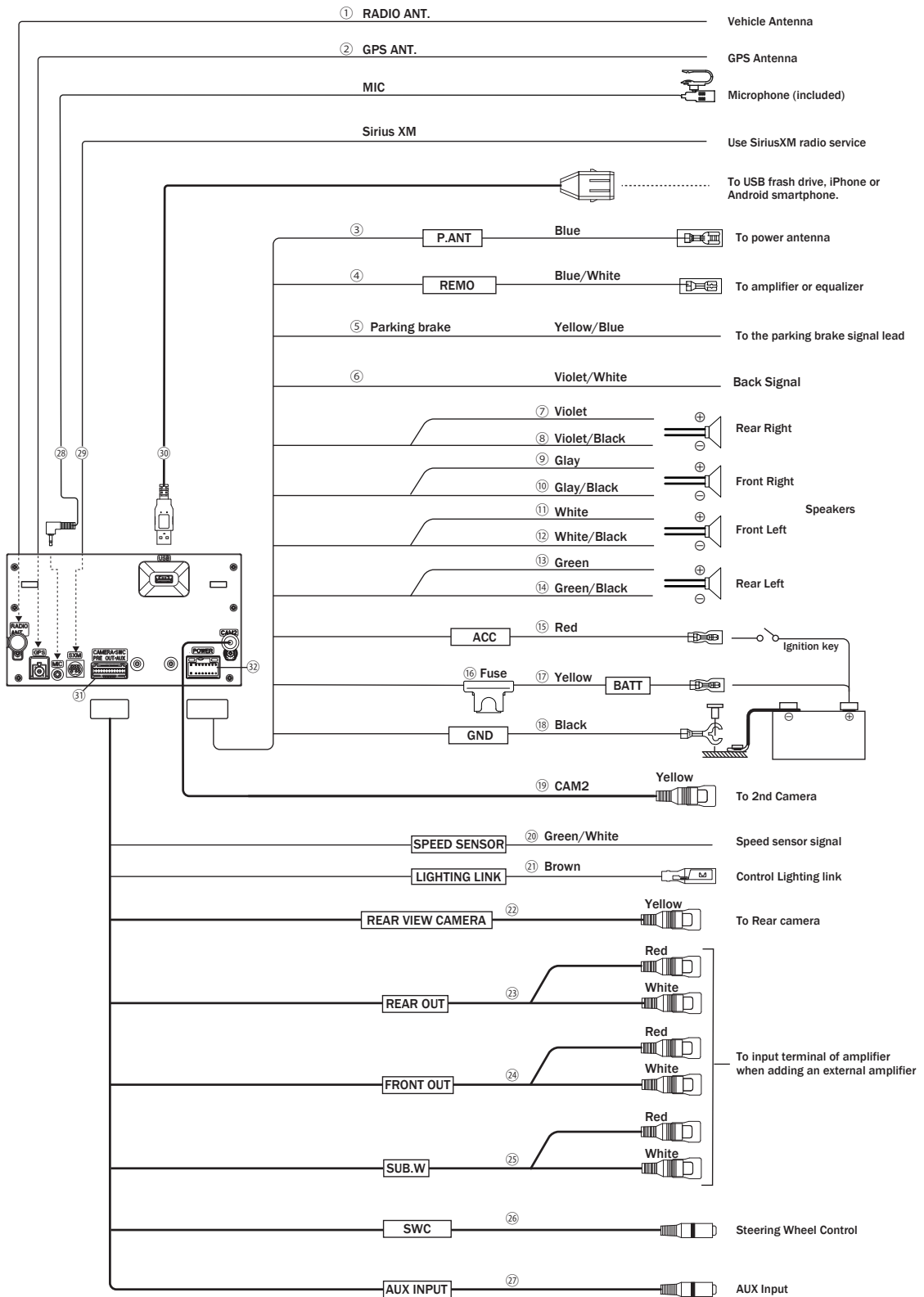

- ① **Radio Antenna Receptacle**
- ② **GPS Antenna Receptacle**
- ③ **Power Antenna Lead (Blue)**
Connect this lead to the +B terminal of your power antenna, if applicable.
 - *This lead should be used only for controlling the vehicle's power antenna. Do not use this lead to turn on an amplifier or a signal processor, etc.*
- ④ **Remote Turn-On Lead (Blue/White)**
Connect this lead to the remote turn-on lead of your amplifier or signal processor.
- ⑤ **Parking Brake Lead (Yellow/Blue)**
Connect this lead to the power supply side of parking brake switch to transmit the parking brake status signals to the unit.
- ⑥ **Reverse Lead (Violet/White)**
- ⑦ **Right Rear (+) Speaker Output Lead (Violet)**
- ⑧ **Right Rear (-) Speaker Output Lead (Violet/Black)**
- ⑨ **Right Front (+) Speaker Output Lead (Gray)**
- ⑩ **Right Front (-) Speaker Output Lead (Gray/Black)**
- ⑪ **Left Front (+) Speaker Output Lead (White)**
- ⑫ **Left Front (-) Speaker Output Lead (White/Black)**
- ⑬ **Left Rear (+) Speaker Output Lead (Green)**
- ⑭ **Left Rear (-) Speaker Output Lead (Green/Black)**
- ⑮ **Switched Power Lead (Ignition) (Red)**
Connect this lead to an open terminal on the vehicle's fuse box or another unused power source that provides (+) 12V only when the ignition is turned on or in the accessory position.
- ⑯ **Fuse Holder (15A)**
- ⑰ **Battery Lead (Yellow)**
Connect this lead to the positive (+) post of the vehicle's battery.
- ⑱ **Ground Lead (Black)**
Connect this lead to a good chassis ground on the vehicle. Make sure the connection is made to bare metal and is securely fastened using the sheet metal screw provided.
- ⑲ **CAN2 (Yellow)**
To 2nd Camera.
- ⑳ **SPEED SENSOR(Green/White)**
- ㉑ **LIGHTING LINK(Brown)**
- ㉒ **REAR CAMERA Input RCA Connector(Black)**
Use when connecting a camera with RCA Output Connector.
- ㉓ **Rear Output RCA Connectors**
Can be used as Rear Output RCA Connectors. RED is right and WHITE is left.
- ㉔ **Front Output RCA Connectors**
Can be used as Front Output RCA Connectors. RED is right and WHITE is left.
- ㉕ **Subwoofer RCA Connectors**
- ㉖ **SWC**
Steering Wheel Control
- ㉗ **AUX INPUT (Black)**
Audio and video input.
- ㉘ **MIC Input Connector**
To microphone (included)
- ㉙ **SiriusXM Tuner Input Connector**
To SiriusXM Tuner (sold separately).
 - *For more information on how to install the SiriusXM Connect Vehicle tuner, consult the installation guide included with the tuner.*
- ㉚ **USB Connector**
To USB flash drive, iPhone or Android smartphone.
- ㉛ **CAMERA/SWC PRE OUT/AUX**
- ㉜ **Power Supply Connector**

If an ACC power supply is not available

Connection Diagram of SPST Switch (sold separately)

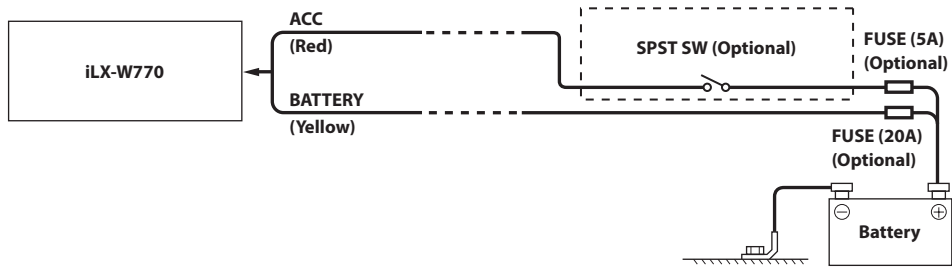

- If your vehicle has no ACC power supply, add an SPST (single-pole, single-throw) switch (sold separately) and fuse (sold separately).
- The diagram and the fuse amperage shown above are in the case when the unit is used individually.
- If the switched power (ignition) lead of the unit is connected directly to the positive (+) post of the vehicle's battery, the unit draws some current (several hundred milliamperes) even when its switch is placed in the OFF position, and the battery may be discharged.

IMPORTANT

Please record the serial number of your unit in the space provided below and keep it as a permanent record. The serial number plate is located on the bottom of the unit.

SERIAL NUMBER: _____

INSTALLATION DATE: _____

INSTALLATION TECHNICIAN: _____

PLACE OF PURCHASE: _____

To prevent external noise from entering the audio system.

- Locate the unit and route the leads at least 10 cm away from the car harness.
- Keep the battery power leads as far away from other leads as possible.
- Connect the ground lead securely to a bare metal spot (remove any paint, dirt or grease if necessary) of the car chassis.
- If you add an optional noise suppressor, connect it as far away from the unit as possible. Your Alpine dealer carries various noise suppressors, contact them for further information.
- Your Alpine dealer knows best about noise prevention measures so consult your dealer for further information.

System Example

Connection of an iPhone

■ When connecting to an iPhone with a Lightning connector

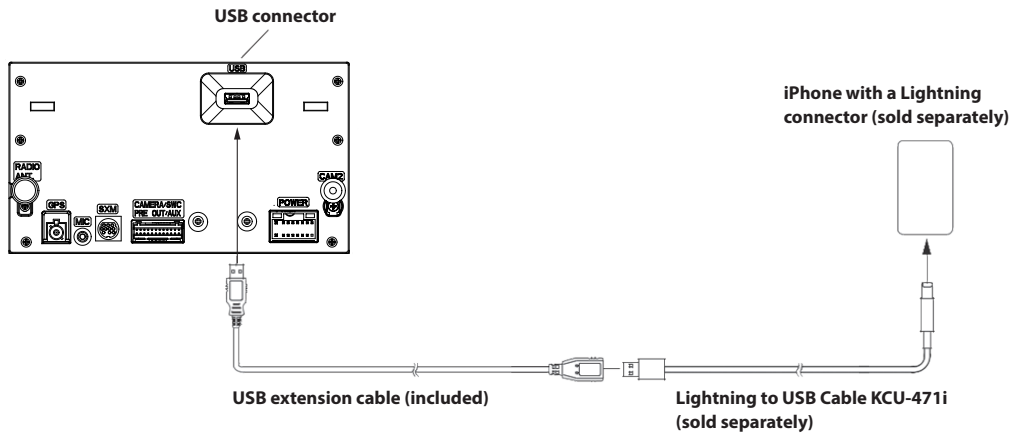

- Do not leave an iPhone in a vehicle for a long time. Heat and humidity may damage the iPhone, and you may not be able to play it again.

Connection of a USB Flash Drive

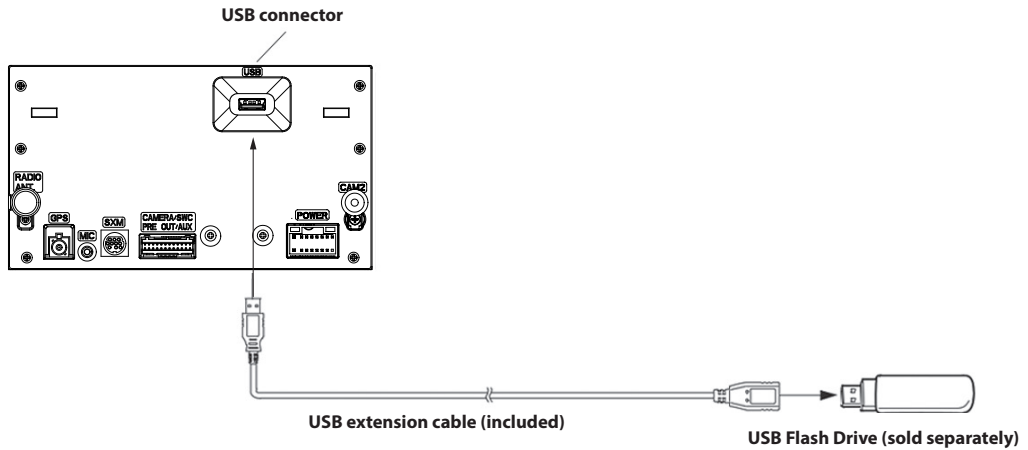

- Do not leave a flash drive in a vehicle for a long time. Heat and humidity may damage the flash drive.

Connection of a camera

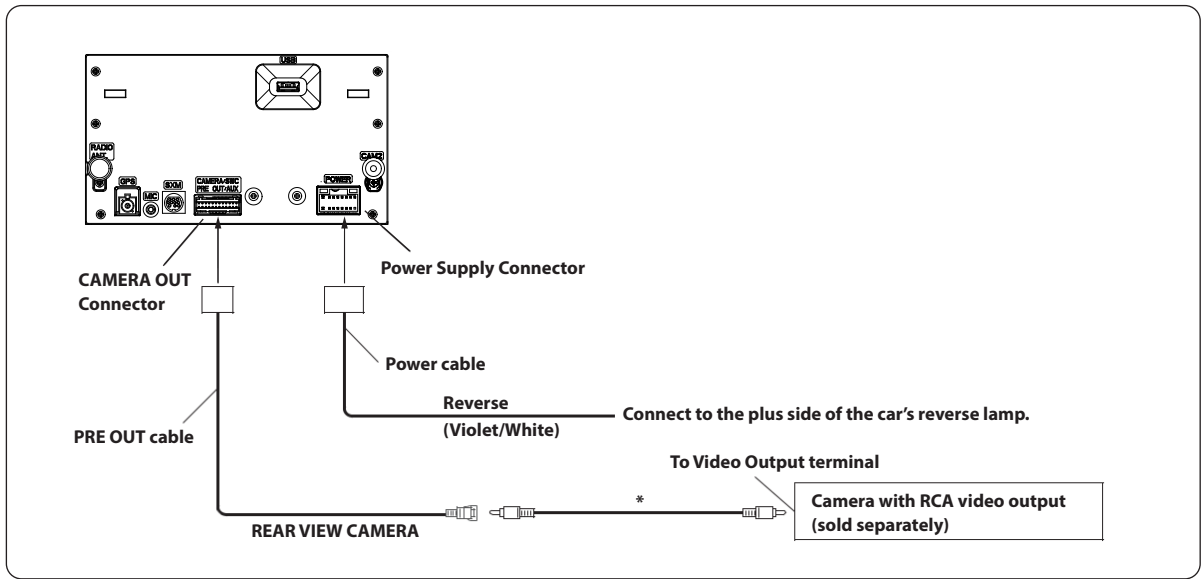

* RCA Extension Cable (sold separately)

Connection of Lighting Link System

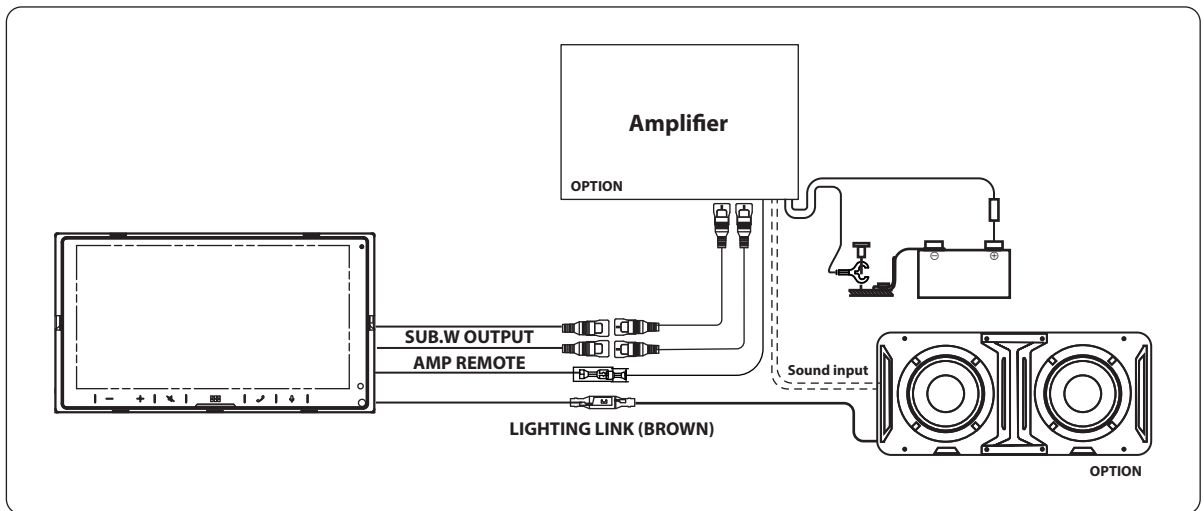

- For complete installation and Sub . Enclosure features, please see Prisma Link enclosure manual.
- When connecting the Lighting Link cable, set the LED Brightness/LED Lighting Speed setting of this unit to 0 (page 26).



LIMITED WARRANTY

ALPINE ELECTRONICS OF AMERICA, INC. ("Alpine"), is dedicated to quality craftsmanship and is pleased to offer this Warranty. We suggest that you read it thoroughly. Should you have any questions, please contact your Dealer or contact Alpine at one of the telephone numbers listed below.

● PRODUCTS COVERED:

This Warranty covers Car Audio Products and Related Accessories ("the product"). Products purchased in the Canada are covered only in the Canada. Products purchased in the U.S.A. are covered only in the U.S.A.

● LENGTH OF WARRANTY:

This Warranty is in effect for one year from the date of the first consumer purchase.

● WHO IS COVERED:

This Warranty only covers the original purchaser of the product, who must reside in the United States, Puerto Rico, Mexico, Brazil, Argentina or Canada.

● WHAT IS COVERED:

This Warranty covers defects in materials or workmanship (parts and labor) in the product.

● WHAT IS NOT COVERED:

This Warranty does not cover the following:

- Damage occurring during shipment of the product to Alpine for repair (claims must be presented to the carrier).
- Damage caused by accident or abuse, including burned voice coils caused by over-driving the speaker (amplifier level is turned up and driven into distortion or clipping). Speaker mechanical failure (e.g. punctures, tears or rips). Cracked or damaged LCD panels. Dropped or damaged hard drives.
- Damage caused by negligence, misuse, improper operation or failure to follow instructions contained in the Owner's manual.
- Damage caused by act of God, including without limitation, earthquake, fire, flood, storms or other acts of nature.
- Any cost or expense related to the removal or reinstallation of the product.
- Service performed by an unauthorized person, company or association.
- Any product which has the serial number defaced, altered or removed.
- Any product which has been adjusted, altered or modified without Alpine's consent.
- Any product not distributed by Alpine within the United States, Puerto Rico or Canada.
- Any product not purchased from an Authorized Alpine Dealer.

● HOW TO OBTAIN WARRANTY SERVICE:

- ① You are responsible for delivery of the product to an Authorized Alpine Service Center or Alpine for repair and for payment of any initial shipping charges. Alpine will, at its option, repair or replace the product with a new or reconditioned product without charge. If the repairs are covered by the warranty, and if the product was shipped to an Authorized Alpine Service Center or Alpine, Alpine will pay the return shipping charges.

- ② You should provide a detailed description of the problem(s) for which service is required.
- ③ You must supply proof of your purchase of the product.
- ④ You must package the product securely to avoid damage during shipment. To prevent lost packages it is recommended to use a carrier that provides a tracking service.

● HOW WE LIMIT IMPLIED WARRANTIES:

ANY IMPLIED WARRANTIES INCLUDING FITNESS FOR USE AND MERCHANTABILITY ARE LIMITED IN DURATION TO THE PERIOD OF THE EXPRESS WARRANTY SET FORTH ABOVE AND NO PERSON IS AUTHORIZED TO ASSUME FOR ALPINE ANY OTHER LIABILITY IN CONNECTION WITH THE SALE OF THE PRODUCT.

● HOW WE EXCLUDE CERTAIN DAMAGES:

ALPINE EXPRESSLY DISCLAIMS LIABILITY FOR INCIDENTAL AND CONSEQUENTIAL DAMAGES CAUSED BY THE PRODUCT. THE TERM "INCIDENTAL DAMAGES" REFERS TO EXPENSES OF TRANSPORTING THE PRODUCT TO THE ALPINE SERVICE CENTER, LOSS OF THE ORIGINAL PURCHASER'S TIME, LOSS OF THE USE OF THE PRODUCT, BUS FARES, CAR RENTALS OR OTHERS COSTS RELATING TO THE CARE AND CUSTODY OF THE PRODUCT. THE TERM "CONSEQUENTIAL DAMAGES" REFERS TO THE COST OF REPAIRING OR REPLACING OTHER PROPERTY WHICH IS DAMAGED WHEN THIS PRODUCT DOES NOT WORK PROPERLY. THE REMEDIES PROVIDED UNDER THIS WARRANTY ARE EXCLUSIVE AND IN LIEU OF ALL OTHERS.

● HOW STATE/PROVINCIAL LAW RELATES TO THE WARRANTY:

This Warranty gives you specific legal rights, and you may also have other rights which vary from state to state and province to province. In addition, some states/provinces do not allow limitations on how long an implied warranty lasts, and some do not allow the exclusion or limitation of incidental or consequential damages. Accordingly, limitations as to these matters contained herein may not apply to you.

● IN CANADA ONLY:

This Warranty is not valid unless your Alpine car audio product has been installed in your vehicle by an Authorized Installation Center, and this warranty stamped upon installation by the installation center.

● HOW TO CONTACT CUSTOMER SERVICE:

Should the product require service, please call the following number for your nearest Authorized Alpine Service Center.

CAR AUDIO	1-800-ALPINE-1 (1-800-257-4631)
NAVIGATION	1-888-NAV-HELP (1-888-628-4357)

Or visit our website at; <http://www.alpine-usa.com>

ALPINE ELECTRONICS OF AMERICA, INC., 1500 Atlantic Blvd, Auburn Hills, Michigan 48326, U.S.A.

Do not send products to this address.

Call the toll free telephone number or visit the website to locate a service center.

About the Rules of Bluetooth Electromagnetic Radiation Regulation

USA/Canada

FCC/IC CAUTION

This device complies with Part 15 of the FCC Rules and Industry Canada's licence-exempt RSSs. Operation is subject to the following two conditions:

- This device may not cause interference; and
- This device must accept any interference, including interference that may cause undesired operation of the device.

Changes or modifications not expressly approved by the party responsible for compliance could void the user's authority to operate the equipment.

This equipment complies with FCC/IC radiation exposure limits set forth for an uncontrolled environment and meets the FCC radio frequency (RF) Exposure Guidelines and RSS-102 of the IC radio frequency (RF) Exposure rules. This equipment has very low levels of RF energy that it deemed to comply without maximum permissive exposure evaluation (MPE). But it is desirable that it should be installed and operated keeping the radiator at least 20 cm or more away from person's body.

Le présent appareil est conforme aux CNR d'Industrie Canada applicables aux appareils radio exempts de licence. L'exploitation est autorisée aux deux conditions suivantes :

- l'appareil ne doit pas produire de brouillage;
- l'utilisateur de l'appareil doit accepter tout brouillage radioélectrique subi, même si le brouillage est susceptible d'en compromettre le fonctionnement.

Cet équipement est conforme aux limites d'exposition aux rayonnements énoncées pour un environnement non contrôlé et respecte les règles des radioélectriques (RF) de la FCC lignes directrices d'exposition et d'exposition aux fréquences radioélectriques (RF) CNR-102 de l'IC. Cet équipement émet une énergie RF très faible qui est considérée conforme sans évaluation de l'exposition maximale autorisée (MPE). Cependant, il est souhaitable qu'il devrait être installé et utilisé en gardant une distance de 20 cm ou plus entre le radiateur et le corps humain.

"La operación de este equipo está sujeta a las siguientes dos condiciones: (1) es posible que este equipo o dispositivo no cause interferencia perjudicial y (2) este equipo o dispositivo debe aceptar cualquier interferencia, incluyendo la que pueda causar su operación no deseada."

resolution 680: "Este equipamento não tem direito à proteção contra interferência prejudicial e não pode causar interferência em sistemas devidamente autorizados."

Don't forget to take a moment to protect your purchase by registering your product now at the following address: www.alpine-usa.com/registration.

N'oubliez pas de consacrer un moment à la protection de votre achat en enregistrant votre produit dès maintenant à l'adresse suivante : www.alpine-usa.com/registration.

Recuerde que con solo unos pocos pasos podrá proteger su producto, registrándolo a través de la siguiente dirección: www.alpine-usa.com/registration.

Open source licenses

This software includes open source software codes licensed under GNU General Public

GNU GENERAL PUBLIC LICENSE
Version 2, June 1991

Copyright (C) 1989, 1991 Free Software Foundation, Inc.
51 Franklin Street, Fifth Floor, Boston, MA 02110-1301 USA

Everyone is permitted to copy and distribute verbatim copies of this license document, but changing it is not allowed.

Preamble

The licenses for most software are designed to take away your freedom to share and change it. By contrast, the GNU General Public License is intended to guarantee your freedom to share and change free software—to make sure the software is free for all its users. This General Public License applies to most of the Free Software Foundation's software and to any other program whose authors commit to using it. (Some other Free Software Foundation software is covered by the GNU Lesser General Public License instead.) You can apply it to your programs, too.

When we speak of free software, we are referring to freedom, not price. Our General Public Licenses are designed to make sure that you have the freedom to distribute copies of free software (and charge for this service if you wish), that you receive source code or can get it if you want it, that you can change the software or use pieces of it in new free programs; and that you know you can do these things. To protect your rights, we need to make restrictions that forbid anyone to deny you these rights or to ask you to surrender the rights. These restrictions translate to certain responsibilities for you if you distribute copies of the software, or if you modify it.

For example, if you distribute copies of such a program, whether gratis or for a fee, you must give the recipients all the rights that you have. You must make sure that they, too, receive or can get the source code. And you must show them these terms so they know their rights.

We protect your rights with two steps:

- (1) copyright the software.
- (2) offer you this license which gives you legal permission to copy, distribute and/or modify the software.

Also, for each author's protection and ours, we want to make certain that everyone understands that there is no warranty for this free software. If the software is modified by someone else and passed on, we want its recipients to know that what they have is not the original, so that any problems introduced by others will not reflect on the original authors' reputations.

Finally, any free program is threatened constantly by software patents. We wish to avoid the danger that redistributors of a free program will individually obtain patent licenses, in effect making the program proprietary. To prevent this, we have made it clear that any patent must be licensed for everyone's free use or not licensed at all.

Detailed license notice, full license texts and machine readable copy of the corresponding source code are readily available on our OSS website (*)

* <http://www.alpine.com/e/oss/download>

Disclaimer

TO THE EXTENT PERMITTED BY APPLICABLE LAW, AND AS PROVIDED IN THE GPL AND LGPL, PIONEER AND ITS LICENSORS PROVIDE AND YOU ACCEPT THE FIRMWARE "AS IS" WITHOUT WARRANTY OF ANY KIND, EXPRESS OR IMPLIED, INCLUDING BUT NOT LIMITED TO ANY IMPLIED WARRANTIES OF MERCHANTABILITY OR FITNESS FOR A PARTICULAR PURPOSE. YOU ACCEPT THE ENTIRE RISK AS TO THE QUALITY AND PERFORMANCE OF THE FIRMWARE.

UNLESS REQUIRED BY APPLICABLE LAW, AND AS PROVIDED IN THE GPL AND LGPL, IN NO EVENT WILL PIONEER OR ITS LICENSORS BE LIABLE TO YOU OR ANY THIRD PARTIES FOR DAMAGES OF ANY KIND ARISING OUT OF YOUR USE OR INABILITY TO USE THE FIRMWARE, INCLUDING WITHOUT LIMITATION ANY DIRECT, INDIRECT, INCIDENTAL, SPECIAL, CONSEQUENTIAL, PUNITIVE OR EXEMPLARY DAMAGES, EVEN IF ADVISED OF THE POSSIBILITY OF SUCH DAMAGES.

This equipment has been tested and found to comply with the limits for a Class B digital device, pursuant to part 15 of the FCC Rules. These limits are designed to provide reasonable protection against harmful interference in a residential installation. This equipment generates, uses and can radiate radio frequency energy and, if not installed and used in accordance with the instructions, may cause harmful interference to radio communications. However, there is no guarantee that interference will not occur in a particular installation. If this equipment does cause harmful interference to radio or television reception, which can be determined by turning the equipment off and on, the user is encouraged to try to correct the interference by one or more of the following measures:

- Reorient or relocate the receiving antenna.
- Increase the separation between the equipment and receiver.
- Connect the equipment into an outlet on a circuit different from that to which the receiver is connected.
- Consult the dealer or an experienced radio/TV technician for help.