



9-INCH ADVANCED NAVI STATION

X409

8-INCH ADVANCED NAVI STATION

X308U

7-INCH ADVANCED NAVI STATION

INE-W987HD

EN

FR

ES

- OWNER'S MANUAL
Please read before using this equipment.
- MODE D'EMPLOI
Veuillez lire avant d'utiliser cet appareil.
- MANUAL DE OPERACIÓN
Léalo antes de utilizar este equipo.

Thank you for purchasing this Alpine product. Please take a moment to protect your purchase by registering your product now at the following address: www.alpine-usa.com/registration. You will be informed of product and software updates (if applicable), special promotions, news about Alpine.

Merci d'avoir acheté ce produit Alpine. Nous vous invitons à consacrer un moment à la protection de votre achat en enregistrant votre produit dès maintenant à l'adresse suivante : www.alpine-usa.com/registration. Vous serez tenu informé des mises à jour des produits et des logiciels (le cas échéant), des promotions spéciales et de l'actualité d'Alpine.

Gracias por adquirir este producto Alpine. Con solo unos pocos pasos podrá proteger su producto, registrándolo a través de la siguiente dirección: www.alpine-usa.com/registration. Recibirá información sobre nuevos productos y software, promociones especiales y novedades sobre Alpine.

Resistant to Dust and Fresh Water (X409 Only)

| | |
|------------------------------|---|
| IP53 rating | Resistant to Dust and Fresh Water. Rated IP53 under IEC standard 60529. |
| IP test condition | <p>This product has been tested in a controlled, laboratory environment with an IP (Ingress Protection) rating of IP53 under IEC standard 60529, which is an international standard for measuring the level of protection from dust and fresh water.</p> <p>The IP rating is a 2-digit code – the first digit indicates the protection level against dust, and the second digit indicates the protection level against fresh water.</p> <p>IP53 means protected against dust with limited ingress, and protected against spraying fresh water up to 60 degrees from vertical.</p> |
| Terms of Use and Risk | <p>Although this product is rated IP53, it is not impervious to dust or water damage in all situations.</p> <ul style="list-style-type: none"> • Dust and water resistance is not permanent; resistance may decrease as a result of normal wear or other damage to the product. • Do not expose to sea/salt water, chlorinated water, mud, detergent or other liquids. • Do not expose to prolonged rain, fog, humidity, temperature changes or other prolonged weather and environmental conditions. Condensation, moisture or debris may accumulate in the product. Close vehicle windows, roof and other openings to avoid exposure to the product. • If the product gets wet, dry thoroughly with a soft cloth. • Open/close the product nose with care – dust or water may enter the product. |
| Disclaimers | <p>Liquid and dust damage are not covered under warranty.</p> <p>Failure to install the product as directed in the installation manual may degrade dust and water resistance.</p> |

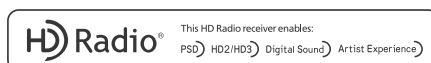

Contents

Operating Instructions

PRECAUTIONS

IMPORTANT INFORMATION 8

WARNING

Points to Observe for Safe Usage 8
WARNING 9
CAUTION 10
NOTICE 10

Features

Favorite Function 12
 About Swiping the Touch Screen 12
 Switching the Audio Sources Screen to a
 Dedicated Screen 13
 About Dual Screen 14
 Dual Screen Display Position 14

Getting Started

Location of Controls 15
 Turning Power On or Off 16
 Turning the System On 16
 Initial System Start-Up 16
 Adjusting the Volume 16
 Lowering Volume Quickly 16
 Touch Screen Operation 17
 Switching Sources 17
 Operating the Function Button on the Audio/
 Video Main Screen 18
 About Basic Operation for List Screen 18
 About the Shortcut Setup Screen 19
 Sound Setup Function 19
 Rear Seat Entertainment Function 20
 About the Menu Screen 21
 Edit Menu 21
 About the Shortcut Key 22
 About the Indicator Display 22

Opening screen Customization 22
 How to Input Characters and Numbers
 (Keypad) 23

Favorite Function

Using the Favorite Function 24
 Editing the Favorite Screen 24
 Registering Items 25
 Changing Item Names 25
 Changing Icons (only the Shortcut Dialing
 and Navigation icons) 25
 Changing the Layout 26
 Deleting Items 26

Applying Alpine Tunelt App

Adjusting the sound via the Smartphone 27

Off-Road Mode (X409 only)

Turning on Off-Road Mode 27

Setup

Setup Operation 28

Wireless (Bluetooth) Setup

Bluetooth Setup 29
 Displaying Bluetooth Information 29
 Pairing a Bluetooth Device 29
 Hands-free Device Primary/Secondary
 Setting 30
 iPhone Auto Pairing Setting 30
 Device Setup 30
 Setting the Passcode 30
 Changing the Character Code of the Phone
 Book 30
 Selecting the Output Speaker 30
 Setting the Microphone Select (X308U/
 INE-W987HD only) 30

General Setup

Sound Setup 31
 Setting the Balance/Fader/Rear Speaker/
 Subwoofer 32
 Setting the Media Xpander (MX HD) 32
 Equalizer Presets 33
 Adjusting the Parametric Equalizer Curve
 (Dual HD EQ) 33
 Adjusting the Crossover Settings
 (X-Over) 34

| | |
|--|----|
| Adjusting the Time Correction (TCR) | 34 |
| Setting Defeat | 34 |
| Setting the Volume for Each Source | 35 |
| Adjusting the Caller Level | 35 |
| Adjusting the Microphone Level | 35 |
| Adjusting the Ring Tone Level | 35 |
| Key Sound Volume Setting | 35 |
| Setting Audio Mute On/Off while Backing up | 35 |
| Setting the Microphone Effect | 35 |
| Default Sound Settings | 35 |
| About the Crossover | 36 |
| About Time Correction | 36 |
| Language Setting | 37 |
| Picture Quality Setup | 37 |
| Selecting the Visual EQ Mode (Factory's setting) | 37 |
| Adjusting Brightness | 38 |
| Adjusting Color of Picture | 38 |
| Adjusting Tint of Picture | 38 |
| Adjusting Image Contrast | 38 |
| Adjusting Picture Quality | 38 |
| Saving and calling the adjusted picture quality | 38 |
| Display/Key Setup | 38 |
| Screen/Lighting Customize | 38 |
| Switching the Display Color (X308U/ INE-W987HD only) | 39 |
| Switching the Illumination Color (X308U/ INE-W987HD only) | 39 |
| Setting the Display Color (Off-Road on/off) (X409 only) | 39 |
| Setting the Text Scroll | 39 |
| Switching the Artwork Position | 39 |
| General Setup | 39 |
| Format settings | 39 |
| About X409/X308U/INE-W987HD | 40 |
| Setting Demo mode to Off/On | 40 |
| Off-Road SWRC Settings (X409 only) | 40 |
| Vehicle Setup | 40 |
| Steering wheel Setting | 40 |
| Installation Setup | 40 |
| Inclinometer Setup (X409 only) | 40 |

Source Setup

| | |
|--|----|
| Radio Setup | 41 |
| Setting the TUNER (FM) Tone Quality (Tuner Condition) | 41 |
| Setting the TUNER (FM) Frequency Step ... | 41 |
| SiriusXM Setup | 42 |

| | |
|---|----|
| Setting the Alert individually for an Artist/ Song/Favorite Team | 42 |
| Setting ON/OFF of all Songs/Artists/Games Alert | 42 |
| Deleting all stored Alert | 42 |
| Setting the Favorite Sports Team Alerts | 42 |
| Setting the Parental Lock | 43 |
| Signal Strength Information | 43 |
| AUX Setup | 43 |
| Setting the Auxiliary (AUX) Name | 43 |
| Switching the Visual Input Signal System ... | 44 |
| HDMI Setup | 44 |
| Setting the Bluetooth Pandora® | 44 |

System Setup

| | |
|---|----|
| Camera Setup | 45 |
| Setting the Camera Input | 45 |
| Setting the Camera Signal Input | 45 |
| Switching Video Source for Multi View Camera | 45 |
| Adjusting the Rear/Front/Side Camera Guide | 45 |
| Camera Interrupt Setting (Power OFF Mode) (Rear Camera Only) | 46 |
| Setting Multi Camera to On/Off | 47 |
| Factory System Setup | 47 |
| Setting the Source Category | 47 |
| Setting the Default Vehicle Screen | 47 |
| Setting the Maestro Module | 47 |
| Rear Seat Entertainment Setup | 48 |
| Remote Sensor Setting | 48 |
| External Accessories Setup | 48 |
| Setting the External Audio Processor | 48 |
| Setting the HDMI Selector On/Off | 48 |
| Setting the External Accessory Control | 48 |
| Smartphone Apps Setup | 49 |

Apple CarPlay (Optional)

| | |
|-------------------------------|----|
| Access to Apple CarPlay | 50 |
|-------------------------------|----|

Android Auto (Optional)

| | |
|-----------------------------|----|
| What is Android Auto | 50 |
| Activate Android Auto | 50 |

Radio/HD Radio™/RBDS

Radio Basic Operation

| | |
|---|----|
| Listening to the Radio | 52 |
| Presetting Stations Manually | 52 |
| Presetting Stations Automatically | 52 |

| | |
|--|----|
| Tuning to Preset Stations | 52 |
| Inputting Frequency Directly and Receiving the Radio Station | 53 |
| Receiving a Multicast (HD Radio™ Mode only) | 53 |
| Selecting the Receivable Program Type (RBDS FM Radio mode only) | 53 |
| Forced Analog Mode | 53 |
| Displaying Radio Text (RBDS FM Radio mode only) | 53 |
| Using Ballgame Mode (HD Radio™ Mode only) | 54 |
| About the Feature Logos | 54 |

USB Flash drive (Optional)

| | |
|--|----|
| Playback | 56 |
| Fast-forwarding/Fast-reversing (USB Video only) | 56 |
| Stopping Playback (USB Video only) | 56 |
| Repeat Play | 56 |
| Random Play (USB Audio only) | 56 |
| Searching for a Desired Song | 56 |
| Switching Display Modes (During Video File Play Back) | 57 |
| About USB Video format | 57 |

iPod/iPhone (Optional)

| | |
|----------------------------------|----|
| Playback | 59 |
| Searching for a Music File | 59 |
| Quick Search Mode | 59 |
| Full Search Mode | 59 |
| Alphabet Search Function | 60 |
| Repeat Play | 60 |
| Random Play (Shuffle) | 60 |

Pandora® Music (optional)

| | |
|--|----|
| Listening to Pandora® | 61 |
| “Thumbs” Feedback | 62 |
| Searching for a Desired Station | 62 |
| Shuffle | 62 |
| Creating a New Station | 62 |
| Bookmarking a Desired Track or Artist | 62 |
| Connecting a Bluetooth Device (Bluetooth Pandora® Only) | 63 |

| | |
|---|----|
| Disconnecting the Bluetooth Connection ... | 63 |
| Changing the connecting Bluetooth Device | 63 |

SiriusXM Satellite Radio Operation (Optional)

| | |
|---|----|
| Receiving Channels with the SiriusXM Tuner | 65 |
| Tuning Channels by Category | 65 |
| Changing the Display | 65 |
| Checking the SiriusXM Radio ID Number | 65 |
| Storing Channel Presets | 65 |
| Tuning Channels using Presets | 65 |
| SmartFavorites Functions | 66 |
| TuneStart™ Function | 66 |
| TuneScan™ Function | 66 |
| Search Function | 66 |
| Selecting the Channel Directly | 67 |
| Storing the desired Song/Artist | 67 |
| Receiving and Tuning to an Alert | 67 |
| Replay Function | 68 |
| Parental Lock Function | 68 |
| Using Jump Memory and Jump Recall function | 68 |

HDMI Device

| | |
|--------------------------------------|----|
| About HDMI selector (Optional) | 69 |
|--------------------------------------|----|

DVD Player Operation

| | |
|------------------------|----|
| DVD Player SETUP | 69 |
|------------------------|----|

CD/MP3/WMA/AAC/WAV

| | |
|--|----|
| Playback | 70 |
| Stopping Playback | 70 |
| Repeat Play | 70 |
| MIX (Random Play) | 70 |
| File/Folder Name Search (Concerning MP3/ WMA/AAC/WAV) | 70 |
| Selecting Folders (Concerning MP3/WMA/ AAC/WAV) | 70 |
| Info Mode Function | 70 |

DVD

| | |
|--------------------------------|----|
| Playing a Disc | 72 |
| If a Menu Screen Appears | 72 |

| | |
|---|----|
| Numeric Keypad Input Operations | 73 |
| Displaying the Top Menu Screen | 73 |
| Displaying the Menu Screen | 73 |
| Playing Still Frames (Pausing) | 73 |
| Stopping Playback | 73 |
| Fast-forwarding/Fast-reversing | 73 |
| Finding the Beginnings of Chapters/Tracks/ Files | 73 |
| Forward/Reverse frame-by-frame Playback | 74 |
| Repeat Playback | 74 |
| Searching by Title Number | 74 |
| Searching Directly by Chapter Number | 74 |
| Switching the Angle | 74 |
| Switching the Audio Tracks | 75 |
| Switching the Subtitles (Subtitle Language) ... | 75 |
| Info Mode Function | 75 |
| Switching Display Modes | 75 |

HDMI Operation

Bluetooth Operation

| | |
|----------------------------------|----|
| Setup Before Using | 77 |
| About Bluetooth | 77 |
| About the Hands-free Phone | 77 |
| Before Using Bluetooth | 77 |

Hands-free Phone Control

| | |
|---|----|
| Answering a Call | 78 |
| Hanging up the Telephone | 78 |
| Call Waiting Function | 78 |
| Calling | 79 |
| Calling by Favorite Function | 79 |
| Making a phone call using the Phone Menu | 79 |
| Using Voice Recognition function | 80 |
| Using Siri | 80 |
| Voice Dial Function | 80 |
| Operations During a Conversation | 81 |
| Adjusting the Speech Volume | 81 |
| Changing the Voice Output | 81 |
| DTMF (Touch-Tone) Function | 81 |
| Phone Book Function | 81 |
| Synchronizing the Phone Book | 81 |
| Adding the Phone Book | 81 |
| Deleting the Phone Book Entries | 82 |
| Searching in the Phone Book | 82 |

Bluetooth Audio

| | |
|---|----|
| Playback | 83 |
| Repeat Play | 83 |
| Random Play | 83 |
| Search Function | 83 |
| Connecting a Bluetooth Device | 84 |
| Disconnecting the Bluetooth Connection ... | 84 |
| Changing the connecting Bluetooth Device | 84 |

Auxiliary Device (Optional)

| | |
|--|----|
| Operating Auxiliary Devices (Optional) | 85 |
| Operating an AUX, AUX DVD or GAME | 85 |
| Operating an External DVD Player | 85 |

Camera Operation (Optional)

| | |
|--|----|
| Rear Camera Operation | 87 |
| Displaying the Rear Camera Image from the Menu screen | 87 |
| Displaying the rear view video while the car is in reverse | 87 |
| Switching the Image for the Rear Camera ... | 87 |
| Guide Display ON/OFF Setting | 87 |
| Adjusting the Caution Display Location | 88 |
| About the Rear Camera Guide | 88 |
| Front Camera Operation | 89 |
| Displaying the Front Camera image from the Menu screen. | 89 |
| Switching the Image Pattern for the Front Camera | 89 |
| About the adjustment of guide display ON/ OFF setting and adjustment of Caution display location | 90 |
| Side Camera Operation | 90 |
| Displaying the Side Camera image from the Menu screen. | 90 |
| Switching the Image Pattern for the Side Camera | 90 |
| Off-Road Camera Operation (X409 only) | 90 |
| Off-Road Rear Camera Operation | 90 |
| Off-Road Front Camera Operation | 91 |
| Off-Road Side Camera Operation | 91 |
| Changing the Camera Source | 92 |
| About the Off-Road Camera information ... | 92 |

iDataLink Operation

| | |
|--|----|
| Access to iDataLink Mode | 94 |
| About Parking Sensor screen | 95 |
| External Accessory Control Operation | 96 |

Information

| | |
|-----------------------------------|-----|
| Product Software Update | 97 |
| About the Supported Formats | 97 |
| About MP3/WMA/AAC/FLAC | 97 |
| About WAV (Disc) | 98 |
| In Case of Difficulty | 99 |
| If this Message Appears | 100 |
| Specifications | 102 |
| END USER LICENSE AGREEMENT | |
| (HERE) | 103 |

LIMITED WARRANTY

Operating Instructions

PRECAUTIONS

IMPORTANT INFORMATION

PLEASE READ CAREFULLY BEFORE USING THIS PRODUCT

This product is intended to provide turn by turn instructions to get you to a desired destination. Please make certain that all persons using this navigation system carefully read these precautions and the following instructions fully.

- This product is not a substitute for your personal judgment. Any route suggestions made by this navigation system may never supersede any local traffic regulations or your personal judgment and/or knowledge of safe driving practices. Do not follow route suggestions if the navigation system instructs you to perform an unsafe or illegal maneuver, places you in an unsafe situation, or routes you into an area which you consider unsafe.
- Glance at the screen only when necessary and safe to do so. If prolonged viewing of the screen is necessary, pull over in a safe and legal manner and location.
- Do not input destinations, change settings, or access any functions requiring a prolonged view of the monitor and/or remote control while you are driving. Pull over in a safe and legal manner and location before attempting to access the system.
- Do not use the navigation system to route you to emergency services. Not all locations of emergency services such as police and fire stations, hospitals and clinics are contained in the database. Please use your own judgment and ask for directions in these situations.
- The map database used in the navigation system is the most recent map data available at the time of production. Because of changes in streets and neighborhoods, there may be situations where the navigation system is not able to route you to your desired destination. In these cases, use your own judgment.
- The map database is designed to provide you with route suggestions and does not take into account the relative safety of a suggested route or of factors which may affect the time required to reach your destination. The system does not reflect road closures or construction, road characteristics (i.e. type of road surface, slope or grade, weight or height restrictions, etc.), traffic congestion, weather conditions, or any other factors which may affect the safety or timing of your driving experience. Use your own personal judgment if the navigation system is unable to provide you with an alternate route.
- There may be situations where the navigation system displays the vehicle's location erroneously. Use your own driving judgment in this situation, taking into account current driving conditions. Please be aware that in this situation the navigation system should correct the vehicle's position automatically. However, there may be times where you may have to correct the position yourself. If this is the case, pull over in a safe and legal manner and location before attempting operation.
- Make certain that the volume level of the navigation system is set to a level which still allows you to hear outside traffic and emergency vehicles.

If there is anything in the manual about the operation of the navigation system which you are uncertain about, please contact your local Alpine authorized navigation dealer or Alpine at 1-888-NAV-HELP (1-888-628-4357) before using the navigation system.

FCC COMPLIANCE STATEMENT

This equipment has been tested and found to comply with the limits for a Class B digital device, pursuant to part 15 of the FCC Rules. These limits are designed to provide more reasonable protection against harmful interference in a residential installation, and are more stringent than "outdoor" requirements.

Operation is subjected to the following two conditions: (1) This device may not cause harmful interference, and (2) this device must accept any interference received, including interference that may cause undesired operation.

This equipment generates, uses, and can radiate radio frequency energy and, if not installed and used in accordance with the instructions, may cause harmful interference to radio communications. However, there is no guarantee that interference will not occur in a particular installation. If this equipment does cause harmful interference to radio or television reception, which can be determined by turning the equipment off and on, you are encouraged to try to correct the interference by one of the following measures:

- Reorient or relocate the receiving antenna.
- Increase the separation between the equipment and the receiver.
- Connect the equipment into an outlet on a circuit different from that to which the receiver is connected.
- Consult an experienced radio/TV technician.

WARNING

Points to Observe for Safe Usage

- *Read this manual carefully before using this disc and the system components. They contain instructions on how to use this product in a safe and effective manner. Alpine cannot be responsible for problems resulting from failure to observe the instructions in this manual.*
- *This manual uses various pictorial displays to show you how to use this product safely and to alert you to potential dangers resulting from improper connections and operation. Following are the meanings of these pictorial displays. It is important to fully understand the meanings of these pictorial displays in order to use this manual and the system properly.*
- *This product may be used with software applications. Please follow all usage instructions and warnings when using this product at all times. Do not use this product or any software application in a manner which will hinder safe operation of your vehicle.*
- *This product may be used in conjunction with the Alpine KAC-001 External Accessory Control module, which works with various accessory products manufactured by third parties. Please review and follow all manufacturer's instructions and warnings for all accessory products.*



WARNING

- Operation of the system while driving is dangerous. Users should stop vehicle before operating the software.
- Road conditions and regulations take precedence over information contained on the map display: observe actual traffic restrictions and circumstances while driving.
- This software is designed for use exclusively in the unit. It cannot and may not be used in conjunction with other hardware.



WARNING

This symbol means important instructions. Failure to heed them can result in serious injury or death.

INSTALL THE PRODUCT CORRECTLY SO THAT THE DRIVER CANNOT WATCH TV/VIDEO UNLESS THE VEHICLE IS STOPPED AND THE EMERGENCY BRAKE IS APPLIED.

It is dangerous for the driver to watch TV/Video while driving a vehicle. Installing this product incorrectly enables the driver to watch TV/Video while driving. This may cause a distraction, preventing the driver from looking ahead, thus causing an accident. The driver or other people could be severely injured.

DO NOT WATCH VIDEO WHILE DRIVING.

Watching the video may distract the driver from looking ahead of the vehicle and cause an accident.

DO NOT OPERATE ANY FUNCTION THAT TAKES YOUR ATTENTION AWAY FROM SAFELY DRIVING YOUR VEHICLE.

Any function that requires your prolonged attention should only be performed after coming to a complete stop. Always stop the vehicle in a safe location before performing these functions. Failure to do so may result in an accident.

DO NOT FOLLOW ROUTE SUGGESTIONS IF THE NAVIGATION SYSTEM INSTRUCTS YOU TO PERFORM AN UNSAFE OR ILLEGAL MANEUVER, OR PLACES YOU IN AN UNSAFE SITUATION OR AREA.

This product is not a substitute for your personal judgement. Any route suggestions by this system should never supersede any local traffic regulations or your personal judgement or knowledge of safe driving practice.

KEEP THE VOLUME AT A LEVEL WHERE YOU CAN STILL HEAR OUTSIDE NOISES WHILE DRIVING.

Excessive volume levels that obscure sounds such as emergency vehicle sirens or road warning signals (train crossings, etc.) can be dangerous and may result in an accident. LISTENING AT LOUD VOLUME LEVELS IN A CAR MAY ALSO CAUSE HEARING DAMAGE.

MINIMIZE DISPLAY VIEWING WHILE DRIVING.

Viewing the display may distract the driver from looking ahead of the vehicle and cause an accident.

DO NOT DISASSEMBLE OR ALTER.

Doing so may result in an accident, fire or electric shock.

USE ONLY IN CARS WITH A 12 VOLT NEGATIVE GROUND.

(Check with your dealer if you are not sure.) Failure to do so may result in fire, etc.

KEEP SMALL OBJECTS SUCH AS SCREWS OUT OF THE REACH OF CHILDREN.

Swallowing them may result in serious injury. If swallowed, consult a physician immediately.

USE THE CORRECT AMPERE RATING WHEN REPLACING FUSES.

Failure to do so may result in fire or electric shock.

DO NOT BLOCK VENTS OR RADIATOR PANELS.

Doing so may cause heat to build up inside and may result in fire.

USE THIS PRODUCT FOR MOBILE 12V APPLICATIONS.

Use for other than its designed application may result in fire, electric shock or other injury.

MAKE THE CORRECT CONNECTIONS.

Failure to make the proper connections may result in fire or product damage.

BEFORE WIRING, DISCONNECT THE CABLE FROM THE NEGATIVE BATTERY TERMINAL.

Failure to do so may result in electric shock or injury due to electrical shorts.

DO NOT ALLOW CABLES TO BECOME ENTANGLED IN SURROUNDING OBJECTS.

Arrange wiring and cables in compliance with the manual to prevent obstructions when driving. Cables or wiring that obstruct or hang up on places such as the steering wheel, gear lever, brake pedals, etc. can be extremely hazardous.

DO NOT SPLICE INTO ELECTRICAL CABLES.

Never cut away cable insulation to supply power to other equipment. Doing so will exceed the current carrying capacity of the wire and result in fire or electric shock.

DO NOT DAMAGE PIPE OR WIRING WHEN DRILLING HOLES.

When drilling holes in the chassis for installation, take precautions so as not to contact, damage or obstruct pipes, fuel lines, tanks or electrical wiring. Failure to take such precautions may result in fire.

DO NOT USE BOLTS OR NUTS IN THE BRAKE OR STEERING SYSTEMS TO MAKE GROUND CONNECTIONS.

Bolts or nuts used for the brake or steering systems (or any other safety-related system), or tanks should NEVER be used for installations or ground connections. Using such parts could disable control of the vehicle and cause fire etc.

DO NOT INSTALL IN LOCATIONS WHICH MIGHT HINDER VEHICLE OPERATION, SUCH AS THE STEERING WHEEL OR GEARSHIFT.

Doing so may obstruct forward vision or hamper movement etc. and results in serious accident.



CAUTION

This symbol means important instructions. Failure to heed them can result in injury or material property damage.

HALT USE IMMEDIATELY IF A PROBLEM APPEARS.

Failure to do so may cause personal injury or damage to the product. Return it to your authorized Alpine dealer or the nearest Alpine Service Center for repairing.

HAVE THE WIRING AND INSTALLATION DONE BY EXPERTS.

The wiring and installation of this unit requires special technical skill and experience. To ensure safety, always contact the dealer where you purchased this product to have the work done.

USE SPECIFIED ACCESSORY PARTS AND INSTALL THEM SECURELY.

Be sure to use only the specified accessory parts. Use of other than designated parts may damage this unit internally or may not securely install the unit in place. This may cause parts to become loose resulting in hazards or product failure.

ARRANGE THE WIRING SO IT IS NOT CRIMPED OR PINCHED BY A SHARP METAL EDGE.

Route the cables and wiring away from moving parts (like the seat rails) or sharp or pointed edges. This will prevent crimping and damage to the wiring. If wiring passes through a hole in metal, use a rubber grommet to prevent the wire's insulation from being cut by the metal edge of the hole.

DO NOT INSTALL IN LOCATIONS WITH HIGH MOISTURE OR DUST.

Avoid installing the unit in locations with high incidence of moisture or dust. Moisture or dust that penetrates into this unit may result in product failure.

FOR MANUAL TRANSMISSION VEHICLES:

For best performance of your rear camera please ensure the vehicle gear shift is not in Reverse prior to starting your vehicle engine.



NOTICE

Security

- 1 This device saves some personal data, including destination data, routing information and phone book data (if your phone book is connected to the unit via Bluetooth).
- 2 Your personal data is not transmitted to any third parties. The only exception to this rule is if you provide the physical device to Alpine or some third party for repair purposes. If provided to Alpine, the personal data would only be used to the extent necessary to conduct the repairs.
- 3 If you wish to delete any and all personal data (for example prior to resale), please use the factory reset option.

Product Cleaning

Use a soft dry cloth for periodic cleaning of the product. For more severe stains, please dampen the cloth with water only. Anything else has the chance of dissolving the paint or damaging the plastic.

Temperature

Be sure the temperature inside the vehicle is between +45°C (+113°F) and 0°C (+32°F) before turning your unit on.

Maintenance

If you have problems, do not attempt to repair the unit yourself. Return it to your Alpine dealer or the nearest Alpine Service Station for servicing.

Protecting the USB connector

- Only an iPod/iPhone or USB flash drive can be connected to the USB connector on this unit. Correct performance using other USB products cannot be guaranteed.
- If the USB connector is used, be sure to use only the supplied connector cable with the unit. A USB hub is not supported.
- Depending on the connected USB flash drive, the unit may not function or some functions may not be performed.
- The audio file format that can be played back on the unit is MP3/WMA/AAC/FLAC.
- Artist/song name, etc., can be displayed. Certain, special characters may not be correctly displayed.



CAUTION

Alpine accepts no responsibility for lost data, etc., even if data, etc., is lost while using this product.

On Handling USB Flash drive

- This unit can control a memory storage device that supports the USB Mass Storage Class (MSC) protocol. Playable audio file formats are MP3, WMA, AAC and FLAC.
- USB Flash drive function is not guaranteed. Use USB flash drive according to the terms of agreement. Read the USB flash drive Owner's Manual thoroughly.
- Avoid usage or storage in the following locations:
 - Anywhere in the car exposed to direct sunlight or high temperatures.
 - Anywhere the possibility of high humidity or corrosive substances are present.
- Fix the USB flash drive in a location where driver operation will not be hindered.
- USB Flash drive may not function correctly at high or low temperature.
- Use only certified USB flash drive. Note that even certified USB flash drive, may not function correctly depending on its type or state.
- Depending on the settings of the USB flash drive type, memory state or encoding software, the unit may not play back or display properly.
- USB Flash drive may take time to start playback. If there is a particular file other than audio in the USB flash drive, it may take considerable time before the file is played back or searched.
- The unit can play back "mp3," "wma" or "m4a" file extensions.
- Do not add the above extensions to a file other than audio data. This non-audio data will not be recognized. The resulting playback may contain noise that can damage speakers and/or amplifiers.
- It is recommended to back up important data on a personal computer.
- Do not remove the USB device while playback is in progress. Change SOURCE to something other than USB, then remove the USB device to prevent possible damage to its memory.

- Windows Media and the Windows logo are trademarks, or registered trademarks of Microsoft Corporation in the United States and/or other countries.
- Apple, iPhone, iPod, iPod nano, iPod touch, and Siri are trademarks of Apple Inc., registered in the U.S. and other countries. Apple CarPlay is a trademark of Apple Inc.
- Use of the Made for Apple and Works with Apple badges means that an accessory has been designed to connect specifically to the Apple product(s) identified in the Made for Apple badge and to work specifically with the technology identified in the Works with Apple badge, and has been certified by the developer to meet Apple performance standards. Apple is not responsible for the operation of this device or its compliance with safety and regulatory standards.
Please note that the use of this accessory with an Apple product may affect wireless performance.
- Pandora®, the Pandora logo, and the Pandora trade dress are trademarks or registered trademarks of Pandora Media, Inc., used with permission. Pandora is currently available in the U.S. only.
- HD Radio Technology manufactured under license from iBiquity Digital Corporation. U.S. and Foreign Patents. For patents see <http://dts.com/patents>. HD Radio and the HD, HD Radio, and "ARC" logos are registered trademarks or trademarks of iBiquity Digital Corporation in the United States and/or other countries.
- Sirius, XM and all related marks and logos are trademarks of Sirius XM Radio Inc. All rights reserved.
- Google, Android, Android Auto, Google Play and other marks are trademarks of Google LLC.
- The Bluetooth® word mark and logos are registered trademarks owned by Bluetooth SIG, Inc. and any use of such marks by Alpine Electronics, Inc. is under license. Other trademarks and trade names are those of their respective owners.
- The terms HDMI and HDMI High-Definition Multimedia Interface, and the HDMI Logo are trademarks or registered trademarks of HDMI Licensing LLC in the United States and other countries.
- MPEG Layer-3 audio coding technology licensed from Fraunhofer IIS and Thomson. Supply of this product only conveys a license for private, non-commercial use and does not convey a license nor imply any right to use this product in any commercial (i.e. revenue-generation) real time broadcasting (terrestrial, satellite, cable and/or any other media), broadcasting/streaming via internet, intranets and/or other networks or in other electronic content distribution systems, such as pay-audio or audio-on-demand applications. An independent license for such use is required. For details, please visit <http://www.mp3licensing.com>
- ©1987-2018 HERE. All rights reserved.

Features

The screen design used in the Owner's Manual may differ from the actual screen.

Favorite Function

Frequently used functions can be easily recalled. For details, see “Favorite Function” (page 24).

Favorite screen example



- Frequently used functions and useful functions can be customized for your convenience.
- You can register up to 54 functions.
- You cannot register a function more than once.

About Swiping the Touch Screen

You can change the source icon display by swiping the touch screen horizontally with your finger. For details, see “Touch Screen Operation” (page 17).

Swipe the display with your finger lightly.



Switching the Audio Sources Screen to a Dedicated Screen

You can switch the Audio Sources screen to a dedicated screen by touching the icon on one of the three edges of the screen.

Shortcut Setup Screen (page 19)



You can set the Sound Setup or Rear Seat Entertainment System.

Dual Screen (page 14)



You can switch between the displayed screens on the Dual Screen.

<Audio Sources Screen>
(USB Audio)



Preset button or Quick Search mode Screen *



* The Search mode differs depending on the audio source. For details, see the operating instructions of the audio source.

About Dual Screen

Dual Screen allows you to display the Navigation and Audio/Visual screens simultaneously.

Audio full Screen



Dual Screen



Navigation full Screen

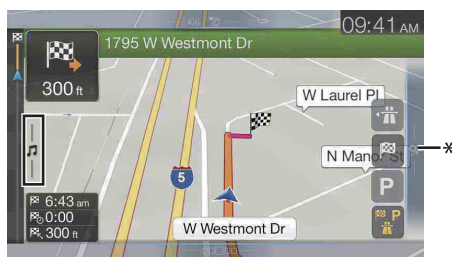

* Touch [🔍] to switch to the Navigation menu screen. For details of navigation operations, refer to "Navigation System OM" in the website at <http://www.alpine-usa.com>.

Dual Screen Display Position

You can switch the left/right positions of the Audio/Visual screen and Navigation screen. Each time you touch [📍], the positions of Audio/Visual screen and Navigation screen switch.

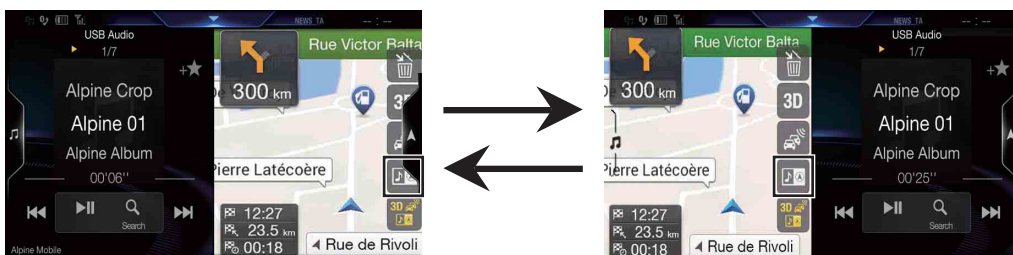

- When [📍] is not displayed, touch [🔍].

Getting Started

Location of Controls

For X308U/INE-W987HD

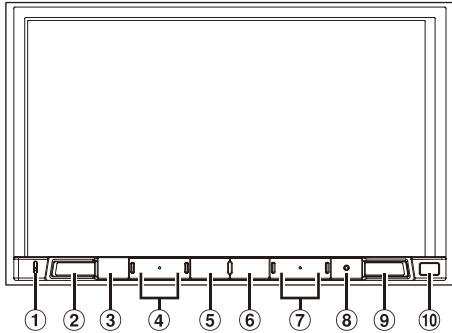

For X409

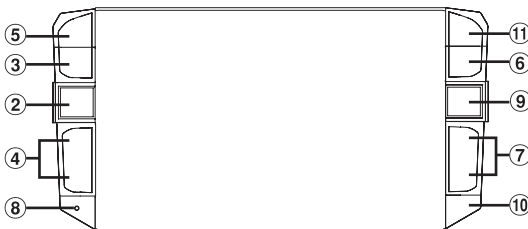

- ① **Microphone (X308U/INE-W987HD only)**
Used for Hands-free or Voice Control modes.
- ② **AUDIO button**
Displays the Audio/Visual screen. If the Audio/Visual screen is already displayed, changes the source.
- ③ **VOICE button**
Depending on the connected smartphone, press to recall Siri function or voice recognition mode.
- ④ **+ / - or ^ / v (UP/DOWN) button**
Press to adjust the volume.
- ⑤ **★ (Favorite) button**
Recalls the Favorite screen.
 - Press and hold this button for at least 2 seconds to switch to the iDataLink mode screen. (When connected to the optional iDataLink module.)
- ⑥ **MENU/ (Power Off) button**
Recalls the Menu screen.
Press and hold this button for at least 5 seconds to turn the power off.
- ⑦ **◀ / ▶ button**
Press to seek down/up a station in radio mode or down/up a track, chapter, etc., in other audio/visual sources.
- ⑧ **RESET switch**
The system of this unit is reset.

- ⑨ **▲ (NAV) button**
Recalls the navigation map screen.
Press again to switch to Navigation menu screen.
Press and hold this button for at least 2 seconds to change to Go Home route screen. (If Home is not set yet, it will change to the Home setting screen.)
When the Apple CarPlay or Android Auto is used, the operation may differ. Press ▲ (NAV) to change the map screen between smartphone and this unit.
For details of navigation operations, refer to "Navigation System OM" in the website at <http://www.alpine-usa.com>.
- ⑩ **Remote Sensor**
Point the remote control transmitter towards the remote sensor within a range of 2 meters.
- ⑪ **📷 (CAMERA) button (X409 only)**
Recalls the camera image screen.

Controllable with Remote Control

This unit can be controlled with an optional Alpine remote control. For details, consult your Alpine dealer. Point the optional remote control transmitter at the remote control sensor.

About the button descriptions used in this Owner's Manual

The buttons found on the face of the unit are expressed in bold (e.g. MENU). The buttons found on the touch-screen display are shown in bold within brackets, [] (e.g. [X]).

Turning Power On or Off

Some of this unit's functions cannot be performed while the vehicle is in motion. Be sure to stop your vehicle in a safe location and apply the parking brake, before attempting these operations.

1 Turn the ignition key to the ACC or ON position.

The system turns on.

- When turned on, the system displays the last screen that was displayed before the ignition key was turned off. For example, if the unit is in radio mode when ignition is turned off, it will remain in radio mode when ignition is turned back on.

2 Press and hold the MENU/ (Power Off) button for at least 5 seconds to turn the power off.

- The unit can be turned on by pressing any button.
- The unit is a precision device. Careful handling of the unit should provide you with years of trouble-free operation.

Turning the System On

When the system is used for the first time, the language selection menu is displayed. Swipe the Language list screen vertically, then touch your choice from the list of 23 languages.

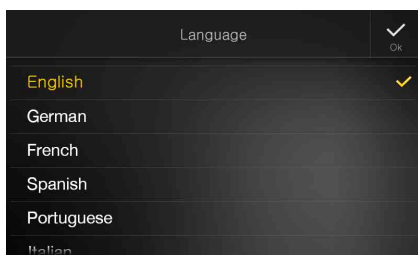

- For your driving safety, please read the warning prompt displayed on this unit carefully.
- Some of this unit's functions cannot be performed while the vehicle is in motion. Be sure to stop your vehicle in a safe location and apply the parking brake before attempting these operations.

Initial System Start-Up

Be sure to press the RESET switch when using the unit for the first time, after changing the car battery, etc.

1 Turn off the unit power.

2 Press the RESET switch with a ballpoint pen or similar pointed object.

For X308U/INE-W987HD

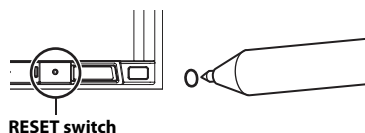

For X409

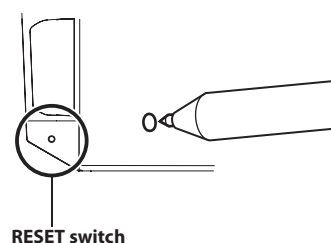

Adjusting the Volume

Adjust the volume by pressing ∇/\wedge or $-/+$.

Volume decreases/increases continuously by pressing and holding ∇/\wedge or $-/+$.

Volume: 0 - 35

Lowering Volume Quickly

Audio Mute function instantly lowers the volume level to 0.

1 Press ∇/\wedge or $-/+$ to display the Volume adjustment screen.

2 Touch the speaker icon to activate the MUTE mode and the speaker icon change to ∇ .

The audio level will be 0 and the MUTE indicator displays.



3 Press ∇/\wedge or $-/+$ to cancel the MUTE mode.

Touch Screen Operation

You can operate the system by using the touch panel on the screen.

- Be sure to touch the onscreen button lightly with the pad of your finger to avoid scratching the display.

Touch operation

Touch a button or list item on the screen lightly.



- If you touch a button and there is no reaction, remove your finger.
- Onscreen buttons that cannot be operated are dimmed.

Swipe operation

Move your finger lightly with a swipe.



Drag & Drop operation

Touch and hold the desired item, then drag it to its new location by moving your finger, then release your finger to place the item.



- It is not possible to narrow the screen with two fingers (pinch in) or spread the screen (pinch out). (Except Navigation map screen)

Switching Sources

Press the  (AUDIO) button to change the source.

Switching sources using the (AUDIO) button

During audio/visual playback, press the  (AUDIO) button repeatedly to switch to the desired source.

Radio → USB/iPod*1 → Factory Media (USB/iPod)*2 → HDMI/DVD*1,3 → Pandora*1 → Bluetooth Pandora*1,4 → SiriusXM*1 or Factory SiriusXM*2 → AUX*3,5 → Bluetooth Audio*1 → Apple CarPlay Music/Google Play Music*6 → Radio

- *1 When no USB flash drive/iPod/HDMI device/Smartphone/Bluetooth compatible device/SiriusXM Tuner is connected, this option is not available. When using Apple CarPlay, some option may not be available.
- *2 Not displayed when your car does not support the source or "Setting the Source Category" (page 47) is set to "Aftermarket." This is also not displayed when the iDataLink module is not connected.
- *3 The name set for "HDMI Setup" (page 44), "Setting the Auxiliary (AUX) Name" (page 43), is displayed.
- *4 When Bluetooth Pandora is set to "Off", this option is not available. (page 44)
- *5 When AUX is set to "Off" this option is not available. (page 43) When the iDataLink module (sold separately) is connected, the Auxiliary (AUX) mode is not available.
- *6 Available when Apple CarPlay is used/Android™ smartphone which installed Android Auto App is connected.

Switching Sources from the Menu screen

1 Press the MENU button.

The menu screen is displayed.

The Audio source selecting area



2 Touch your desired source in the Audio source selecting area.

- In the menu screen, you can change the Audio source directly or change the order in which sources change. For details, see "About the Menu Screen" (page 21).

Operating the Function Button on the Audio/Video Main Screen

Using the Function button on the Audio/Visual main screen.

Swipe to the right or left to change to the Function mode.

■ HD Radio main screen example

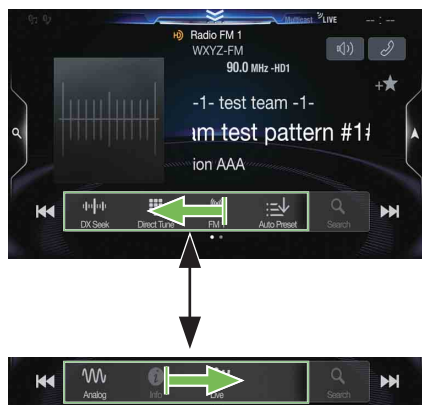

About Basic Operation for List Screen

Basic operations on the Setup list screen and the Search list screen.

How to display on the list screen differs depending on the selected item.

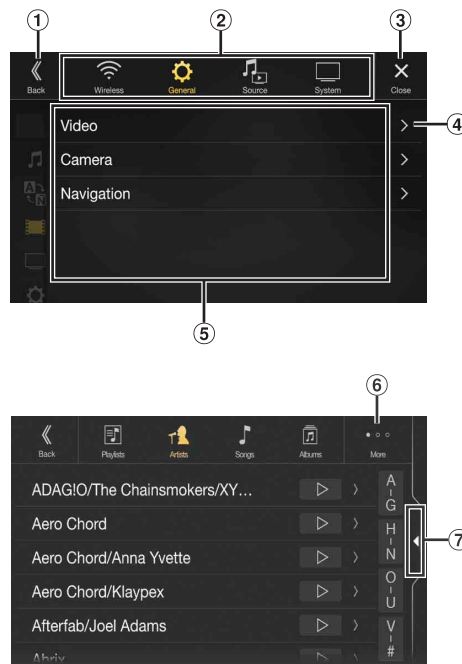

- ① Switches to the menu screen or the previous screen.
- ② Item select button
- ③ Closes the window.
- ④ Displays the next list page.
 - When the next selection item does not exist, the list item is not displayed.
- ⑤ Lists items for selection
 - When there are more than five list items, the page can be changed by swiping vertically.
- ⑥ Changes the page of the Item select button ② above.
 - “•” indicates the total number of pages, “◦” indicates the location of the current page.
- ⑦ List screen close button
 - Touch or swipe to the left on the search screen, etc. to close the list screen.

About the Shortcut Setup Screen

Displaying the Sound Setup screen, or the Shortcut Setup screen of the Rear Seat Entertainment System screen.

Touch the top part of the Audio source screen.



The Sound Setup screen or the Rear Seat Entertainment System Setup Screen is displayed.

Sound Setup screen (Tone Adjustment mode) example



- ① Close the window
- ② You can adjust the Navi voice interrupt volume (Navi Guide) and the Background Audio volume during Navi Guide.
Navi Volume : 1 -35
Background Audio : 0 -35
- ③ Button for Display Off *
- ④ Displays the registered Bluetooth Device List screen.
• See "Pairing a Bluetooth Device" (page 29).
- ⑤ Touch this to change to the currently playing source screen.
- ⑥ Displays the Hands-free Device Primary/Secondary setting screen.
• See "Hands-free Device Primary/Secondary Setting" (page 30).

* Display Off mode

- To cancel Display Off mode, touch the screen or press any button (except +/– or ^/∨ button).
- Display Off mode is canceled when the power or ACC is turned off.
- When the gear lever is shifted to the reverse (R) position and the rear camera is connected, the rear camera image is displayed.
- When a call is received on a Bluetooth-connected phone, the incoming call screen is displayed.

Sound Setup Function

■ Tone Adjustment mode

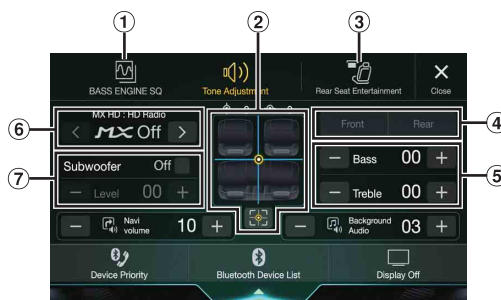

■ BASS ENGINE SQ mode



- ① Button for changing the BASS ENGINE SQ mode screen
- ② Balance/Fader Image area*¹
 - To reset to the initial settings (Balance: 0, Fader: 0), touch [EQ].
- ③ Rear Seat Entertainment Function screen switch button
 - When Setting the Rear Seat Entertainment is "Off", you cannot change the screen. For details on Rear Seat Entertainment setting, see "Rear Seat Entertainment Setup" (page 48).
- ④ Buttons for switching between Front/Rear when adjusting Bass/Treble*²
- ⑤ Buttons for adjusting Bass Level/Treble Level*^{3, 4}
- ⑥ Buttons for adjusting Media Xpander *^{1, 3, 5}
- ⑦ Buttons for adjusting Subwoofer On/Off and Subwoofer Level *^{1, 3}
- ⑧ Button for changing the Tone Adjustment mode screen
 - If changing to the Tone Adjustment mode, BASS ENGINE SQ mode will be disabled.
- ⑨ Buttons for adjusting the BASS ENGINE Level*⁴
- ⑩ Buttons for selecting the BASS ENGINE type *⁴

*¹ You can perform a more detailed set up in "Sound Setup" (page 31).

*² You cannot switch when Front/Rear Sync in "Adjusting the Parametric Equalizer Curve (Dual HD EQ)" (page 33) is "On."

*³ When you switch to the BASS ENGINE SQ mode, the value you have set is ignored.

*⁴ When the Defeat setting is "On," you cannot perform the set up.

*⁵ Not available during an interruption such as traffic announcement is broadcasting.

Adjusting Bass Level/Treble Level

Bass Level and Treble Level can be set independently set for Front and Rear speakers by touching [Front] or [Rear].

Setting item:

Bass / Treble

Setting contents:

-14 to +14 (Initial setting: 0)

- When "BASS ENGINE SQ" is selected in the Shortcut Setup, this setting is disabled.
- Adjustment cannot be performed when Defeat is set to "On."
- The Bass adjusted setting value is interlinked with Band2 of Dual HD EQ, and the Treble adjusted setting value is interlinked with Band8.

Setting the BASS ENGINE SQ

Setting the BASS ENGINE Type

Creating the ideal Bass impact for your musical taste using BASS ENGINE SQ.

Setting contents:

Standard (Initial setting) / Punch / Rich / Mid Bass / Low Bass

- | | |
|-----------|--|
| Standard: | Mild low-end boost with mid-range focus for front-center staging. |
| Punch: | Mid-bass punched up with mid-range impact. |
| Rich: | Accented highs and mid-bass giving outstanding balance for all types of music. |
| Mid Bass: | Strong high frequency emphasis with mid-bass boost for more low-end attack. |
| Low Bass: | Strong, low-bass boost with extended highs for a very dynamic sound. |

Adjusting the BASS ENGINE Level

You can adjust the BASS ENGINE Level.

Setting item:

BASS ENGINE Level

Setting contents:

0 to 6 (Initial setting: 3)

- The BASS ENGINE Level of the BASS ENGINE SQ is common to all the types.

About setup when the external power amplifier is connected

In order to optimize the BASS ENGINE SQ mode, we recommend the following procedure to set up the power amplifier.

Use your favorite music to make the following amplifier adjustment.

- 1) Set GAIN of the power amplifier to "MIN."
- 2) Set the Crossover Mode Selector switch to "OFF"
 - If the switch has no "OFF" position, set as near as possible to full range.
- 3) Set the BASS ENGINE Level to "03."
- 4) Play a song of the genre you frequently listen to, and adjust GAIN of the power amplifier.

Rear Seat Entertainment Function

The Rear Seat Entertainment function independently routes different sources to the front and the rear side of the car. For example, while listening to the radio or other audio sources in the front, HDMI can be enjoyed at the rear with optional rear monitors and headphones.

Rear Seat Entertainment System Setup screen

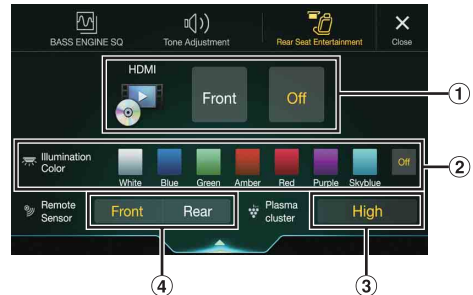

- ① Visual source selection area that is displayed on the Rear monitor.*1
Touch the source icon displayed on the Rear monitor.
Front: The image and sound of the same visual source as the unit are output.
Off: Stops output to the Rear monitor.
- ② Illumination Color button
The color coordination select button of the Rear monitor:
White/Blue/Green/Amber/Red/Purple/Skyblue/Off
(This function is depended on Over Head Monitor)
- ③ Plasmacluster air volume adjustment button*2
Whenever you touch the button, you can change the air volume.
Off → Low → Mid → High → Off
 - While the plasmacluster is operating, the indicator is displayed on the Audio source screen.
- ④ Remote Sensor
You can set whether the sensor on Rear monitor receives remote control operation, or the unit receives it.

*1 The visual source that can be output to the Rear monitor is "HDMI/DVD." When the unit plays back the visual source, you can only select the same visual source as the unit.

*2 When the Plasmacluster in "Setting the Rear Seat Entertainment System" (page 48) is set to "Off," the Plasmacluster air volume adjustment button is not displayed.

- If the same visual source is being output to both the unit and the Rear monitor when an incoming/outgoing call is made, the visual/audio output to the Rear monitor is interrupted temporarily depending on the source.
If different visual sources are being output to the unit and the Rear monitor, visual/audio output to the Rear monitor continues without interrupting playback.

About the Menu Screen

In the menu screen, you can select the audio source and perform various setups or operations on the unit.

Press the MENU button.

The menu screen is displayed.

Menu screen example

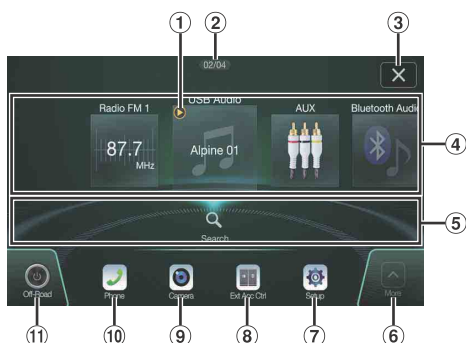

- ① Displays the currently playing audio source.
- ② Displays the total number of the audio sources that can be selected. Also displays the current position, counting from the leftmost audio source.
- ③ Touch to return to previous source screen.
- ④ Audio source select area
 - Touch your desired source icon to change the audio source.
 - *Swiping to the right or left in the Audio source select area, you can change the audio source.*
 - *The source icon displayed in the Audio source select area is the one checked on the Edit menu screen. For details on how to display/ hide the source icon, see "Edit Menu" (page 21).*
- ⑤ Displays Preset No, and information of the Search mode, etc., located in the middle of the Audio source select area.
 - *Touch the desired preset number or the Search mode to change the audio source directly.*
 - *The displayed information differs depending on the audio source. Some sources are not displayed.*
- ⑥ Touch to display more icons. (Displayed only when icons' number over 5.)
- ⑦ Setup button
 - Displays the Setup screen. (page 28)
- ⑧ External Accessory Control button
 - Is displayed when the optional External Accessory Control module is connected and "Setting the External Accessory Control" is set to "On" (page 48).
 - *You can operate the external accessories from this unit. For details, see "External Accessory Control Operation" (page 96).*
- ⑨ Camera button*1
 - Displays camera images. (page 87)
- ⑩ Phone button*2
 - Displays the Phone menu screen. (page 77)
- ⑪ Off-Road button*3
 - Activate/Deactivate Off-Road Mode.
 - *Depending on the setting and connected devices, the displayed icons and orders may differ. Touch ⑥ to display more icons such as [Android Auto]*4, [Apple CarPlay]*5 and [Vehicle Info]*6.*

*1 Displays when the Camera Select is set to "Front," "Rear," or "Other." (page 45)

*2 Displays when the Bluetooth setting is set to "On." (page 29)

*3 X409 only

*4 Displays the Android Auto screen, displayed when an Android Smartphone installed Android Auto App is connected. (page 50)

*5 Displays the Apple CarPlay screen, displayed when an iPhone 5 or later is connected. (page 50)

*6 Displays the iDataLink mode screen. (page 94)

Edit Menu

You cannot operate the Edit Menu screen while driving.

Your vehicle must be parked with the ignition key in the ACC or ON position. For details, see "To display the Setup Menu screen" in "Setup Operation" (page 28).

In the Edit Menu screen, you can change the audio source order or set the display/hidden settings.

1 Touch the desired source icon in the Menu screen for at least 2 seconds.

A checkbox (or) is displayed on the upper left area of the source icon and switches to the edit mode.



- *The source icon displayed in the Edit Menu screen is displayed only when usable setup and conditions of each Audio source are fulfilled. For details on setup and conditions of each audio source, see "Switching Sources" (page 17).*

Changing the order of Audio source

Drag and drop the source icon to the desired location.

Hiding/Displaying Audio source

Place a check in the checkbox () to display the Audio source icon. Uncheck the checkbox () to hide it.

- *You cannot hide the icon of a source that is currently playing.*

2 Touch [Done].

The editing content is confirmed, and returns to the menu screen.

- *Editing here is reflected in the order of (AUDIO) button touching and change of the Audio source. (page 17)*

About the Shortcut Key

There are two shortcut keys on Audio source screen (Radio, USB Audio, etc.). You can quickly switch to Sound Setup screen or Phone Menu screen by touching the shortcut key.



- ① Sound setup shortcut button
Touch to display Bal./Fad. Screen of Sound setup. Refer to "Setting the Balance/Fader/Screen of Sound setup" (page 32).
- ② Phone shortcut button
Touch to display Phone Menu screen. Refer to "Hands-free Phone Control" (page 77).

About the Indicator Display

The Indicator Bar at the bottom of the screen displays various types of information, like the current time.



- ① Lights up when connected to a Bluetooth compatible device. (Does not display when connection is set to OFF.)
 : Bluetooth connection to audio device
 : Bluetooth connection to Hands Free Phone
 Blinks while reconnecting.
- ② Indicates the battery level of the connected Bluetooth device*.

| Battery Level | Level 3 | Level 2 | Level 1 | No Battery |
|---------------|---------|---------|---------|------------|
| Icon | | | | |

This may not be displayed depending on the connected Bluetooth device. Whenever one battery level decreases, the alarm sounds.

- ③ Indicates the signal strength level of the connected Bluetooth compatible device*.
Displayed when Bluetooth setting is ON.

| 0 | 1 | 2 | 3 | No Service |
|---|---|---|---|------------|
| | | | | |

- ④ Plasmacluster indicator
Indicates the setting value (Low/Mid/High) selected in "Plasmacluster air volume adjustment."
- ⑤ The clock display
You can switch between the 12 hour display and 24 hour display options.
For details of the clock display settings, refer to "Navigation System OM" in the website at <http://www.alpine-usa.com>.
- ⑥ Bluetooth devices Name*

* When you connect two Hands-Free Phones, the information of the Bluetooth device set to Primary is displayed.

Opening screen Customization

You can set a BMP image that is stored on a USB flash drive as the opening screen. This setting requires the following image format, folder name and file name.

Usable file format:

- BMP image
- Image size: 800 × 480 pixels (RGB 24 bit or less/number of color bit: 24, 8, 1 bit)
- Compression format: non-compressed
- Folder name*¹: **OPENINGFILE**
- File name*²: **openingfile.bmp**

- 1 Connect the USB flash drive to the USB extension cable.**
A message confirming the opening screen change is displayed.
- 2 Touch [OK].**
An update indicator "⌂" (Loading)" is displayed, and update for the opening screen starts.
- 3 After the update is complete, the following message is displayed.*³**
"The logo has been updated successfully! Please remove Flash Memory and press OK."
- 4 After removing the USB flash drive, touch [OK].**
The opening screen setting is complete.

*¹ Be sure to save the folder to the first layer of the USB flash drive.

*² Only one BMP image can be set as the opening screen.

*³ If "Customization failed," is displayed, touch [OK] and then check that the folder name, file name and file format are correct.

- Do not perform the following actions during the update.
 - Do not turn off the ACC to the car.
 - Do not unplug the USB flash drive.
 - Do not turn off or operate the unit.
- To return the opening screen to its original image, you must Clear All Settings. Be careful of this operation, as your other settings are also initialized. For details, see "Initializing the System" (page 40).

How to Input Characters and Numbers (Keypad)

The displayed screens and procedures may vary slightly depending on the function used, but the basic input method is the same.

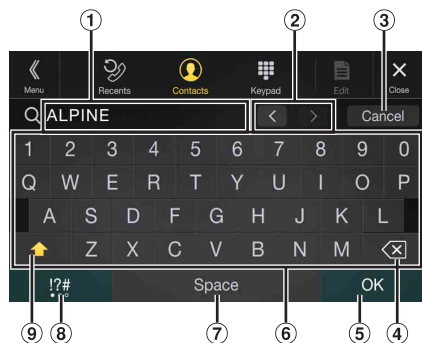

- ① Input screen area.
- ② Cursor position alteration switch
- ③ Cancel
- ④  (Delete)
Keypad mode finishes.
Returns to the previous character and erases it.
Touching here for more than 2 seconds will erase all input characters.
- ⑤ Input number is confirmed.
- ⑥ Character keypad
- ⑦ Space
- ⑧ Special character selector switch
Switches the Alphanumeric/Special characters/Symbols character type.
- ⑨ Uppercase letter switching key

Favorite Function

Using the Favorite Function

This unit enables you to recall functions easily by registering frequently used items such as the Audio source, the navigation search function, etc. to the Favorite screen. You can recall any of these items easily.

1 Press the ★ (Favorite) button.

The Favorite screen is displayed.

Favorite screen example



- ① Changes to the Edit screen used for registering items or changing names.
- ② Close the Favorite screen
- ③ Favorite registration item
Swipe to left or right to change the pages. You can add up to 6 pages.
- ④ Indicates the location of the currently displayed Favorite screen.

2 Touch your desired Favorite registered item.

The desired item is displayed.

- When making a phone call by choosing shortcut dialing, after the message of confirmation of outgoing phone calls is displayed, touch [Call]. For details, see "Calling by Favorite Function" (page 79).

Editing the Favorite Screen

You cannot edit the Favorites screen while driving.

Your vehicle must be parked with the ignition key in the ACC or ON position. For details, see "To display the Setup Menu screen" in "Setup Operation" (page 28).

1 Touch [Edit] (Edit).

A checkbox is displayed on the upper left area of the registration icon and it changes to Edit mode.

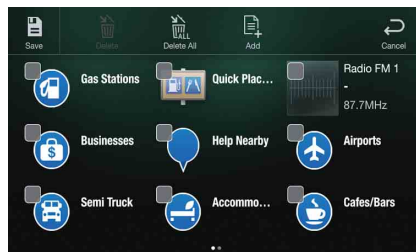

Setting item:

Item registration / Item name change / Icon change / Layout change / Item deletion

2 After editing is complete, touch [Save] (Save).

3 After the caption for the confirmation is displayed, touch [Yes].

4 Editing is complete.

- If you touch [Cancel] while editing, a confirmation prompt will appear. Touch [Yes], the edits are reset and the screen returns to the previous Edit screen.

Registering Items

1 Touch [] (Add).

The items to be added (categories) are displayed.

2 Touch the desired item to be added (category).



3 Choose the desired item to be added.

- You can add up to 54 items.
- You cannot register an item more than once.

Audio/Visual

[Radio]*1 / [USB/iPod] / [Factory Media (USB/iPod)]*2 / [HDMI/DVD] / [Pandora] / [Bluetooth Pandora] / [SiriusXM]*3 or [Factory SiriusXM]*2, 3 / [AUX]*4 / [Bluetooth Audio] / [Apple CarPlay]*5 / [Android Auto]*5

- *1 Choose a frequency from Preset 1 - 12 in any of the tuner preset bands.
- *2 Not displayed when your car does not support the source or "Setting the Source Category" (page 47) is set to "Aftermarket." This is also not displayed when the iDataLink module is not connected.
- *3 You can choose a channel registered to Presets 1 - 18.
- *4 When "AUX" is selected, the source name set in "Setting the Auxiliary (AUX) Name" (page 43) is also displayed in the Favorite screen. When the iDataLink module (sold separately) is connected, the Auxiliary (AUX) mode is not available.
- *5 You can register now playing Apple CarPlay Music or Google Play Music depending on the connected Smartphone.

- When using Apple CarPlay, some option may not be available.
- You can also register directly by touching [+★] in the Audio source screen.



However, if it is already registered, [+★] is not displayed.

Navigation

[Specific Place]:

You can display places registered in Favorite and set your destination.

[Quick Place Search]:

Displays the address search keypad.

[Help Nearby]:

Displays the nearby search screen.

[Place Categories]:

Displays the selected Place Categories list.

- For details of navigation operations, refer to "Navigation System OM" in the website at <http://www.alpine-usa.com>.

Phone (Shortcut Dialing)*6

You can register the user's shortcut dialing stored in the Phone Book.

- If multiple phone numbers are stored, select a number you want to register.
- You can register directly by touching [+★] of the Contacts list. (page 77)
- You can change the icon you registered. (page 25)

*6 You can only select Phone when a mobile phone is connected. For details on how to register a mobile phone and downloading Phone Book, see "Bluetooth Operation" (page 77).

Changing Item Names

1 Touch the text area of the registered item.

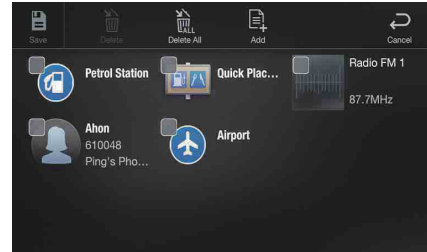

The Input User Name screen (Keypad) is displayed.

2 Input the name and touch [OK].

- For details on how to input characters using the keypad, see "How to Input Characters and Numbers (Keypad)" (page 23).

Changing Icons (only the Shortcut Dialing and Navigation icons)

You can change the icons of Shortcut Dialing and Navigation category. The following example explains how to change the Shortcut Dialing icon. Perform the same procedure to change the Navigation category icon.

1 Touch the icon that you want to change.

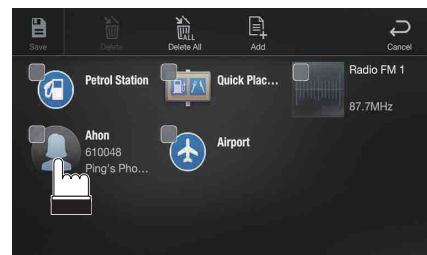

The icon list is displayed.

2 Touch the icon you want to change from the icon list.

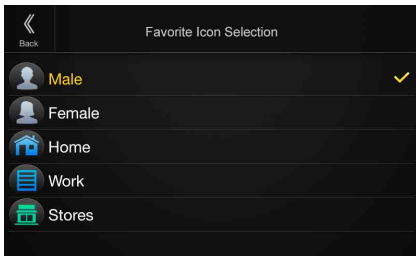

The icon is changed to the selected icon.

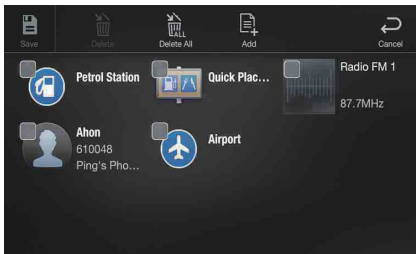

Changing the Layout

Drag and drop the item to the desired location.



The item location is changed.

- When you move to other pages, switch pages, or when you make a new page and move to another, drag to the end of the screen, and lift your finger after the page changes.

Deleting Items

When deleting a selected item

1 Touch the checkbox at the left of the item you want to delete and place a check (✓) in it.

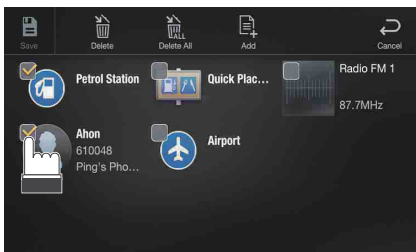

2 Touch [🗑️] (Delete).

The selected item will be deleted.

When deleting all items

Touch [🗑️] (Delete All).



All items are deleted.

Applying Alpine Tunelt App

This unit's sound tuning is programmable from a connected Smartphone. It is also possible to download specific parameters for certain vehicles from Alpine's Tunelt database stored in the Cloud. Using the Alpine Tunelt App, customized parameters can also be uploaded for others to share and rate.

Through this unit, it is also possible to receive and respond to information from Alpine's Social Network Service (SNS) available through the connected Smartphone.

The installed Alpine Tunelt App should be launched on the Smartphone before connection to the head unit.

Alpine Tunelt App, is downloadable from Apple's App Store; the Android user can download it from Google Play™. For details, consult your Alpine dealer.

Before these operations, set Tunelt to USB (iPhone) or Bluetooth (Android) depending on the connected Smartphone. For details, see "Smartphone Apps Setup" (page 49).

- The application program and related specifications and data may be deleted or terminated without notice.
- Some Alpine Tunelt App functions may not be available if the Smartphone is not in a service area or receives no signal.

Adjusting the sound via the Smartphone

After setting the above procedure, you can adjust the unit's sound function on the Smartphone.

- 1 Make sure the unit is powered on.**
- 2 Launch the Alpine Tunelt App on the Smartphone. Adjust the unit's sound accordingly on the Smartphone.**

- The setting cannot be done on both the Smartphone and this unit at the same time. While the sound function of this unit is set via Smartphone, the sound function settings on the unit will be displayed as "Sound APP Connected."
- In some situations, such as the unit is powered off or during a call, etc., sound setting cannot be done via the Smartphone.
- This function may not be available depending on the paired Smartphone.
- Please obey all local traffic laws while using this function.
- When "Setting the External Audio Processor" (page 48) "On," this function is not available.

Off-Road Mode (X409 only)

X409 Off-Road Mode adds Off-Road Navi and Off-Road Camera (page 90). The key features include: vehicle inclinometer, Tracking Distance/Time, and Super Wide-angle Camera which improve visibility to enhance Off-Road driving. Off-Road Mode must be turn on from the radio [Menu] button screen.

Turning on Off-Road Mode

- 1 Press the MENU button.**
The Menu screen is displayed.



[Off-Road] button

- 2 Touch [Off-Road].**
Off-Road Mode is turned on and the Off-Road button turns green.
Touch [Off-Road] again to turn Off-Road Mode off. The button color will turn gray.
- The background image and menu theme will change when Off-Road Mode is turned on, see "Setting the Display Color (Off-Road on/off) (X409 only)" (page 39).
 - When Off-Road Mode is turned on additional vehicle information (Pitch/Roll, Tire Pressure, Battery Voltage, Latitude/Longitude, and Heading) will be displayed on the Camera screen and Off-Road Navigation screen.

Setup

Setup Operation

To display the Setup Menu screen:

Your vehicle must be parked with the ignition key in the ACC or ON position. To do this, follow the procedures below.

- 1 Bring your vehicle to a complete stop at a safe location. Engage the parking brake.
- 2 Release the parking brake. (For safety, release the parking brake while depressing the foot brake pedal).
- 3 Engage the parking brake again.

- For automatic transmission vehicles, place the transmission lever in the Park position.

Now, the locking system for the Setup operation has been released. Engaging the parking brake can reactivate the Setup Menu, as long as the car's ignition has not been turned off. It is not necessary to repeat the above procedure (1 through 3) of "To display the Setup Menu screen."

Each time the ignition is turned OFF, perform the procedure of "To display the Setup Menu screen."

1 Press the MENU button.

The Menu screen is displayed.



[Setup] button

- Touch [X] will return to previous source screen.

2 Touch [Setup].

The Setup main screen is displayed.



3 Touch the required setting icon on the upper part of the Setup main screen or swipe the list area vertically, then touch the setting item.

Setting items:

Wireless: See "Wireless (Bluetooth) Setup" (page 28).

General: See "General Setup" (page 31).

Source: See "Source Setup" (page 41).

System: See "System Setup" (page 44).

Wireless (Bluetooth) Setup

[Wireless] is selected on the Setup main screen in step 3. See "Setup Operation" (page 28).

■ Wireless Setup Menu screen

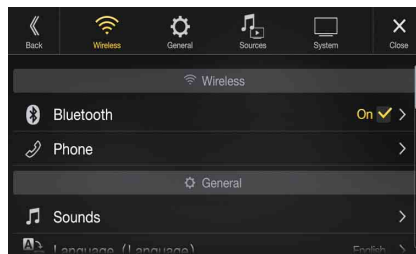

<Setting items>

| Bluetooth | |
|---|--|
| Bluetooth Information*1/2 | |
| Set Bluetooth Device*1/2 | |
| Hands-free Device Priority*1/2 | |
| iPhone Auto Pairing*1/2 | |
| Device | |
| Passcode Change | |
| Default Phone Book Format | |
| Phone Speaker | |
| Microphone Select (X308U/INE-W987HD olny) | |

*1 This setting is only available when "Bluetooth" is set to "On" (☑).

*2 Cannot be adjusted when Apple CarPlay is used/Android smartphone which installed Android Auto App is connected.

The following steps 1 to 3 are common to each "Setting item" of Wireless Setup. See each section for details.

1 Select the desired item.

2 To switch the setting, touch [⟨], [⟩], [+], [−], or mark the checkboxes "Off" (☐) or "On" (☑).

- If ">" appears, there is a further hierarchy. Touch the desired item.

3 Touch [X] to return to the main source screen.

- To return to the previous List screen, touch [⟨] in the previous page. For details, see "About Basic Operation for List Screen" (page 18).

Bluetooth Setup

[Bluetooth] is selected on the Wireless Setup Menu screen in step 1. See “Wireless (Bluetooth) Setup” (page 28). You can register and set up Bluetooth compatible devices.



Setting item:

Bluetooth

Setting contents:

Off / On (Initial setting)

- Off: Bluetooth function is not used.
- On: Turn ON to begin phone pairing process.

- Cannot be adjusted when Apple CarPlay is used/Android smartphone which installed Android Auto App is connected.

Displaying Bluetooth Information

Make sure the “Bluetooth” setting is “On” (☑). You can display the Bluetooth device name and device address of this unit.

Setting item:

Bluetooth Information

Pairing a Bluetooth Device

Make sure the “Bluetooth” setting is “On” (☑). See “Bluetooth Setup” (page 29). Search for Bluetooth compatible devices.

Setting item:

Set Bluetooth Device

1 Touch [Q] (Search) of “No Device.”

The Bluetooth devices can be searched are displayed in a list.



2 Touch [🎵] (Audio), [📞] (Hands-free) or [📞/🎵] (Both) of the device you want to connect from the list.

- Audio: Device is used as an Audio device.
- Hands-free: Device is used as a Hands Free Device.
- Both: Device is used as both an Audio device and Hands Free Device.

- You can register up to 5 Bluetooth compatible mobile phones.
- You can connect three Bluetooth Devices; two exclusively for Hands-Free Phone and one exclusively for Bluetooth Audio.
- When you register a Hands-Free Phone for the first time, Primary is set automatically. When you connect two Hands-Free Phones, select “Hands-free” or “Both.” You can then set the priority on the Primary/Secondary setting screen. For details, see “Hands-free Device Primary/Secondary Setting” (page 30).

3 When the device registration is complete, a message appears and the device returns to normal mode.

- The Bluetooth registration process differs depending on the device version and SSP (Simple Secure Pairing). If a 4 or 6 character Passcode appears on this device, enter the Passcode using the Bluetooth compatible device. If a 6 character Passkey appears on this device, make sure the same passkey is displayed on the Bluetooth compatible device and touch “Yes.”
- If all 5 devices have been registered, you cannot register a 6th device. To register another device, you need to delete one of the other 5 devices first.

Setting the Bluetooth Device

Select one of 5 paired Bluetooth compatible devices that you previously registered.

Touch [🎵] (Audio) or [📞] (Hands free) of the device you want to connect from the Paired Device list.



Deleting a Bluetooth Device from the list

You can delete the information of a previously connected Bluetooth compatible device.

1 Touch [🗑️] (Delete) of the Bluetooth compatible device to delete from the Paired Device list.

2 Touch [OK].

- Touching [Cancel] will cancel the setting.

Hands-free Device Primary/Secondary Setting

Make sure the “Bluetooth” setting is “On” (☑). See “Bluetooth Setup” (page 29).

When you connect two Hands-Free Phones, set the priority of the operation and the setting of incoming-outgoing calls.

Setting item:

Hands-free Device Priority

Setting contents:

Primary / Secondary

Touch the checkbox for Primary/Secondary of the device names that are registered to the unit to set them.

- When connected to two hands-free phones, operating restrictions apply to the hands-free phone registered to Secondary. For details, see “Hands-free Phone Control” (page 77).

iPhone Auto Pairing Setting

Make sure the “Bluetooth” setting is “On” (☑). See “Bluetooth Setup” (page 29).

When an iPhone is connected via USB and it is not on the Registered Device list, it will be paired automatically.

Setting item:

iPhone Auto Pairing

Setting contents:

On / Off (Initial setting)

On: Performs iPhone Auto Pairing setting.
Off: Does not perform iPhone Auto Pairing setting.

- This setting supports iPhones with iOS Ver.5.5 or later.
- When more than 5 Bluetooth devices are registered, Auto Pairing does not start.

Device Setup

[Device] is selected on the Wireless Setup Menu screen in step 1. See “Wireless (Bluetooth) Setup” (page 28).

You can make various settings for a Bluetooth compatible device.



Setting the Passcode

You can set the code for connecting with a Bluetooth compatible device.

Setting item:

Passcode Change

- 1 Enter a 4-digit passcode (old), and then touch [OK].**
 - The initial number is 0000.
 - For details on how to input the numeric keypad, see “Numeric Keypad Input Operations” (page 73).
- 2 Enter a 4-digit passcode (new), and then touch [OK].**

- 3 Enter the passcode that you entered in step 2 again, and then touch [OK].**

Changing the Character Code of the Phone Book

You can select the character code that is used when transferring the phone book or history from a mobile phone. If unreadable characters appear in the transferred data, select the correct character code.

Setting item:

Default Phone Book Format

Setting contents:

Latin-1 / Latin-9 (Initial setting) / Russian / Chinese / Thai / Arabic / UTF-8 / UTF-16LE / UTF-16BE

| | |
|----------|-------------|
| Latin-1: | ISO 8859-1 |
| Latin-9: | ISO 8859-15 |
| Russian: | ISO 8859-5 |
| Chinese: | GB18030 |
| Thai: | CP874 |
| Arabic: | CP1256 |
| UTF-8 | |
| UTF-16LE | |
| UTF-16BE | |

Selecting the Output Speaker

You can select which speaker in the car will output the audio from the phone.

Setting item:

Phone Speaker

Setting contents:

All (Initial setting) / Front Left / Front Right / Front Left + Right

| | |
|---------------------|---|
| All: | The sound is output from all speakers in car. |
| Front Left: | The sound is only output from the front left speaker. |
| Front Right: | The sound is only output from the front right speaker. |
| Front Left + Right: | The sound is output from the front left and front right speakers. |

- The setting cannot be adjusted during a phone call. Adjust the setting before placing a call.
- This option is not available when “External Audio Processor” (page 48) is set to On.

Setting the Microphone Select (X308U/INE-W987HD only)

You can select the built-in microphone or the supplied microphone as a Hands-Free Microphone.

Setting item:

Microphone Select

Setting contents:

Built-in / Add-on (Initial setting)

| | |
|-----------|--|
| Built-in: | Use the built-in microphone. (see location on page 15) |
| Add-on: | Use the supplied microphone. |

General Setup

[General] is selected on the setup main screen in step 3. See "Setup Operation" (page 28).

General Setup Menu screen

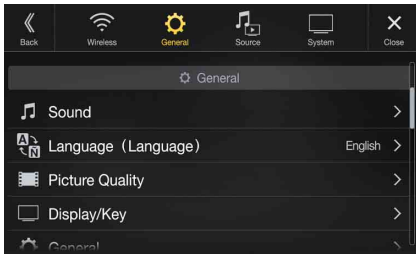

<Setting item>

| |
|--|
| Sound |
| Balance / Fader*1 |
| Rear Speaker*2 |
| Subwoofer*2 |
| Subwoofer Level*1, 2, 3, 5 |
| Subwoofer Phase*2, 3 |
| MX HD*1, 4, 5 |
| EQ Presets*4, 5 |
| Dual HD EQ*4, 5 |
| X-Over*5 |
| Time Correction (TCR) |
| Defeat |
| Source Volume Setup |
| Caller Level*6 |
| Microphone Level*6 |
| Ring Tone Level*6 |
| Key Sound Feedback |
| Mute While Backing Up |
| Microphone EC/NR |
| Default Sound Settings |
| Language (Language) |
| Picture Quality |
| Video*7 |
| Camera*8 |
| Navigation |
| Display/Key |
| Screen/Lighting |
| Screen Color (X308U/INE-W987HD only) |
| Illumination Color (X308U/INE-W987HD only) |
| Screen Color (Off-Road on/off) (X409 only) |
| Text Scroll |
| Artwork Position |
| General |
| Format |
| About |
| Demo Mode |
| Off-Road SWRC Settings*9 (X409 only) |

| |
|----------------------------|
| Vehicle |
| Steering wheel |
| Installation Status |
| Inclinometer*9 (X409 only) |

- *1 You can make this setting in the Sound Setup screen of the Shortcut Setup. For details, see "Sound Setup Function" (page 19).
- *2 You can also make the setting in the Bal./Fad. screen. For details on how to adjust, see "Setting the Balance/Fader/Rear Speaker/Subwoofer" (page 32).
- *3 This setting is only available when "Subwoofer" is set to "On" (☑).
- *4 When the Defeat setting is "On", you cannot perform the set up.
- *5 When "BASS ENGINE SQ" is selected in the Shortcut Setup, this setting is disabled.
- *6 Not displayed when Apple CarPlay is used/Android smartphone which installed Android Auto App is connected.
- *7 "Video" can be selected while a video is playing.
- *8 The camera names are not displayed when Camera Select (page 45) is set to "Off".
- *9 Not displayed when Off-Road Mode is set to Off.

The following steps 1 to 3 are common to each "Setting item" of General Setup. See each section for details.

- 1 Select the desired item.
- 2 To switch the setting, touch [⟨], [⟩], [+], [-], or mark the checkboxes "Off" (☐) or "On" (☑).
 - If ">" appears, there is a further hierarchy. Touch the desired item.
- 3 Touch [X] to return to the main source screen.
 - To return to the previous List screen, touch [⟨] in the previous page. For details, see "About Basic Operation for List Screen" (page 18).

Sound Setup

[Sound] is selected on the General Setup Menu screen in step 1. See "General Setup" (page 31).

You can set up items related to the sound quality.

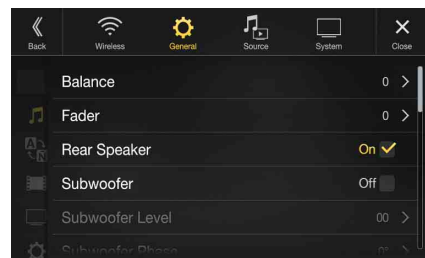

- X409 is designed exclusively for a certain car model. The Initial setting for sound setup items may differ from the description of Owner's Manual.

Setting the Balance/Fader/Rear Speaker/ Subwoofer

Set Balance/Fader/Rear Speaker/Subwoofer/Subwoofer Level/ Subwoofer Phase in the Bal./Fad. screen.

Setting item:

Balance*1 / Fader*1 / Rear Speaker / Subwoofer*2 / Subwoofer Level*1, 2 / Subwoofer Phase*1

*1 When selecting either of the above setting items, the Bal./Fad. screen is displayed.

*2 When "BASS ENGINE SQ" is selected in the Shortcut Setup, this setting is disabled.

- This setting can also be activated by touching Sound Setup shortcut key on Audio source screen. Refer to "About the Shortcut Key" (page 22).

■ Fad./Bal. screen

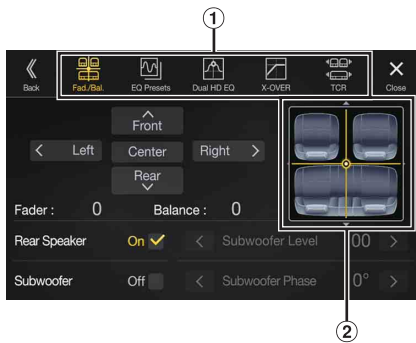

- Enables you to change to each setting screen.
- Balance/Fader Image area

Setting the Balance/Fader

Touch the desired point within the image area. Or touch [∨][∧][<][>].

Balance:

L15 to R15

Fader:

F15 to R15

- To reset to the initial setting (Balance: 0, Fader: 0), touch [Center].

Rear Speaker Setting

You can set the rear speaker output to "Off".

Setting item:

Rear Speaker

Setting contents:

On (Initial setting) / Off

Turning Subwoofer ON/OFF

If an optional subwoofer is connected to the unit, make the following setting.

Setting item:

Subwoofer

Setting contents:

On / Off (Initial setting)

Adjusting the Subwoofer Level

You can set the Subwoofer level when a Subwoofer is connected.

Setting item:

Subwoofer Level

Setting contents:

0 to 15 (Initial setting: 0)

- This setting is only available when "Subwoofer" is set to "On" (☑).

Setting the Subwoofer Phase

The subwoofer output phase is toggled Subwoofer Normal (0°) or Subwoofer Reverse (180°).

Setting item:

Subwoofer Phase

Setting contents:

0° (Initial setting) / 180°

- This setting is only available when "Subwoofer" is set to "On" (☑).

Setting the Media Xpander (MX HD)

Media Xpander (MX HD) makes vocals or instruments sound distinct regardless of the music source. The HD-Radio Technology (FM)/ SiriusXM, USB Flash drive and iPod/iPhone, will be able to reproduce the music clearly even in cars with a lot of road noise.

Setting item:

MX HD

- When the Defeat setting is "On," you cannot perform the set up.
- When "BASS ENGINE SQ" is selected in the Shortcut Setup, this setting is disabled.
- The MX HD setting can be performed only when a source is currently selected.

■ Adjustable source (media) and setting value

HD-Radio™ (FM)/SiriusXM: Off (Initial setting) / Level1 / Level2 / Level3

The medium to high frequencies become more clear, and produces well balanced sound in all the bands.

Compressed Media/Factory Audio: Off (Initial setting) / Level1 / Level2 / Level3

This corrects information that was omitted at the time of compression. This reproduces a well-balanced sound close to the original.

HDMI/AUX: Off (Initial setting) / Compressed Media / Movie / Music

Choose the MX HD mode (Compressed Media, Movie, or Music) that corresponds to the media connected.

(Movie)

The dialog portion of the video is reproduced more clearly

(Music)

This file contains a large quantity of data such as music clip. MX uses this data to reproduce the sound accurately.

- The effect increases as the MX HD setting value increases Level1 → Level2 → Level3.
- You can set this for each source.
- iPod/iPhone/USB Audio/USB Video/Bluetooth Audio/Pandora/Bluetooth Pandora/Apple CarPlay Music/Google Play Music correspond to Compressed Media.
- Factory Media (USB/iPod)/Factory SiriusXM correspond to Factory Audio.

Equalizer Presets

10 typical equalizer settings are preset at the factory for a variety of musical source material.

Setting item:

EQ Presets

Setting contents:

FLAT (Initial setting) / POP / ROCK / NEWS / JAZZ / ELECTRONIC / HIP HOP / EASY LISTENING / COUNTRY / CLASSICAL

- Only one type can be set to ON.
- When Equalizer Presets is set, the linked Dual HD EQ settings are also changed. We recommend storing Dual HD EQ settings in a Preset in advance.
- The Equalizer Presets setting can be configured when Defeat is "Off."

Adjusting the Parametric Equalizer Curve (Dual HD EQ)

Parametric Equalizer (Dual HD EQ) can adjust the center frequency/Q Factor (bandwidth)/level for the front and rear speakers independently. You can adjust only to the approximate frequency zone, but can then compensate by performing advanced correction of the sound.

Setting item:

Dual HD EQ

- When the Defeat setting is "On," you cannot perform the set up.
- When "BASS ENGINE SQ" is selected in the Shortcut Setup, this setting is disabled.

1 Adjust the Dual HD EQ to your preference.

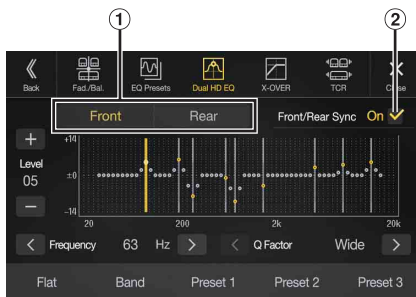

- ① Front/Rear speaker switching button
Not displayed when Front/Rear Sync is "On" ()
- ② Front/Rear speaker interlock button

- On: When you want the Front and Rear speakers to have the same setting, set to "On" ()
Off: When you want to set the Front and Rear speakers independently, set to "Off" ()

Adjusting the Band

Touch **[Band]** to select the band to be adjusted.

Band1 → Band2 → ... → Band8 → Band9 → Band1

- You can select a band directly by touching the screen.

Adjusting the Frequency

Touch [**<**] or [**>**] of "Frequency" to adjust the frequency of the selected band.

Adjustable frequency bands:

20 Hz to 20 kHz (in 1/3 octave steps)

| | |
|--------|------------------------|
| Band1: | 20 Hz~100 Hz (63 Hz) |
| Band2: | 63 Hz~315 Hz (125 Hz) |
| Band3: | 125 Hz~500 Hz (250 Hz) |
| Band4: | 250 Hz~1 kHz (500 Hz) |
| Band5: | 500 Hz~2 kHz (1 kHz) |
| Band6: | 1 kHz~4 kHz (2 kHz) |
| Band7: | 2 kHz~7.2 kHz (4 kHz) |
| Band8: | 5.8 kHz~12 kHz (8 kHz) |
| Band9: | 9 kHz~20 kHz (16 kHz) |

Adjusting the Level

Touch [**-**] or [**+**] of "Level" to adjust the level of selected band.

Setting contents:

-14 to +14 (Initial setting: 0)

Setting the Bandwidth

Touch [**<**] or [**>**] of "Q Factor" to select the bandwidth.

Setting contents:

Wide (Initial setting) / Medium / Narrow

2 To adjust another band, repeat step 1, and adjust all bands.

3 To store the adjusted setting value, touch and hold [Preset 1], [Preset 2], or [Preset 3] for at least 2 seconds.

- Band2 and Band8 are the same as the Bass and Treble controls.
- For details on setting Bass and Treble, see "Adjusting Bass Level/Treble Level" (page 20).
- Settings exceeding the frequency of adjacent bands are not available.
- While adjusting the Dual HD EQ, you should consider the frequency response of the connected speakers.
- When the Dual HD EQ is adjusted, the Equalizer Presets are overridden.
- When Equalizer Presets is set, the linked Dual HD EQ settings are also changed. We recommend storing Dual HD EQ settings in a Preset in advance.
- Touch **[Flat]** to initialize all values.

Calling the Dual HD EQ adjusted value

Calling the pre-set Dual HD EQ adjusted value.

Touch [Preset 1], [Preset 2], or [Preset 3] on the Dual HD EQ screen.

The setting stored in the Preset will be recalled.

Adjusting the Crossover Settings (X-Over)

Before performing the following procedures, see “About the Crossover” (page 36).

Setting item:

X-Over

- When “BASS ENGINE SQ” is selected in the Shortcut Setup, this setting is disabled.

1 Touch [Channel] to select the channel.

Each time you touch, the channel switches.



- The channel being adjusted is displayed in red.
Front HPF → Rear HPF → Subw. LPF → Front HPF

2 Adjust the crossover to your preference.

Selecting the Cut-Off Frequency

Touch [<] or [>] of “Frequency,” and then select the cut-off frequency.

Setting contents:

20 / 25 / 31.5 / 40 / 50 / 63 / 80 (Initial setting) / 100 / 125 / 160 / 200 Hz

Adjusting the Slope

Touch [<] or [>] of “Slope,” and then adjust the HPF or LPF slope.

Setting contents:

0 (Initial setting) / 6 / 12 / 18 / 24 dB/oct.

Adjusting the Level

Touch [–] or [+] of “Level,” and then adjust the HPF or LPF level.

Setting contents:

-12 to 0 dB (Initial setting: 0)

3 Repeat steps 1 to 2 to make adjustment to the other channels.

4 To store the adjusted setting value, touch and hold [Preset 1], [Preset 2], or [Preset 3] for at least 2 seconds.

- Touch [Flat] to initialize all values.
- If the Rear Speaker setting is “Off,” the Rear Speaker setting cannot be edited (page 32).
- If the Subwoofer setting is “Off,” the Subwoofer setting cannot be edited (page 32).
- While adjusting the X-Over you should consider the frequency response of the connected speakers.

Calling the X-Over adjusted value

Calling the pre-set X-Over adjusted value.

Touch [Preset 1], [Preset 2], or [Preset 3] on the X-Over screen.

The setting stored in the Preset will be recalled.

Adjusting the Time Correction (TCR)

Before performing the following procedures, see “About Time Correction” (page 36).

Setting item:

Time Correction

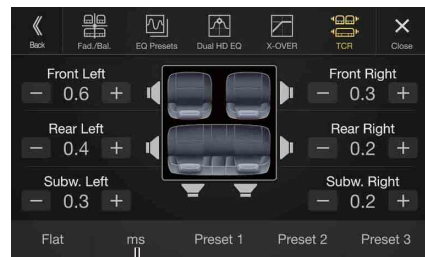

Correction mode

1 Touch the Correction mode button.

The pop up screen for selecting the correction mode is displayed.

2 Touch [ms], [cm] or [inch] to select the mode for making adjustments.

The selected mode is displayed on the Correction mode button.

3 Touch [–] or [+] for each speaker to adjust the time or distance.

0.0 msec to 9.9 msec (0.1 msec/step)

0.0 cm (0.0 inch) to 336.6 cm (132.7 inch) (3.4 cm/step)

All speaker setting values are adjustable in the range of 15 ms or 510 cm.

4 To store the adjusted setting value, touch and hold [Preset 1], [Preset 2], or [Preset 3] for at least 2 seconds.

- Touch [Flat] to set all values to 0.0.
- If the Rear Speaker setting is “Off,” the Rear Speaker setting cannot be edited (page 32).
- If the Subwoofer setting is “Off,” the Subwoofer setting cannot be edited (page 32).

Calling the Time Correction Value

Calling the pre-set time correction value.

Touch [Preset 1], [Preset 2], or [Preset 3] on the time correction screen.

The setting stored in the Preset will be recalled.

Setting Defeat

If Defeat is “On,” MX HD, Equalizer Presets and Dual HD EQ functions are turned Off. This disables any settings made for these functions.

Setting item:

Defeat

Setting contents:

Off (Initial setting) / On

Setting the Volume for Each Source

Setting item:

Source Volume Setup → Radio / SiriusXM / Compressed Media*¹ / iPod Music / AUX*² / HDMI*^{2,3} / Bluetooth Audio / Factory Audio*⁴ / Apple CarPlay*⁵ / Android Auto*⁵

Setting contents*⁶:

-14 to +14 (Initial setting: 0)

*¹ Compressed Media is the music data and video data in a USB flash drive (MP3/WMA/AAC/FLAC/AVI/MKV/MP4).

*² The source name set in "HDMI Setup" (page 44) and "Setting the Auxiliary (AUX) Name" (page 43) is displayed.

*³ Not displayed when an HDMI device is not connected.

*⁴ Not displayed when an iDataLink module is not connected.

*⁵ Available when an iPhone 5 or later/Android smartphone which installed Android Auto App is connected.

*⁶ Except for Apple CarPlay/Android Auto mode.

- Settable source differs depending on the connected device and settings.

Setting the Volume for Apple CarPlay

When an iPhone 5 or later is connected, after touching [Apple CarPlay], you can adjust Media, Phone Calls, Ringtones & Alerts level, Notifications & Guidance level, Siri and Microphone Level for Apple CarPlay mode.

Setting item:

Media / Phone Calls / Ringtones & Alerts / Notifications & Guidance / Siri / Microphone Level

Setting contents for Media:

-14 to +14 (Initial setting: 0)

Setting contents for Ringtones & Alerts:

1 to 6 (Initial setting: 3)

Setting contents for other items:

1 to 11 (Initial setting: 5)

Setting the Volume for Android Auto

When an Android Smartphone is connected, after touching [Android Auto], you can adjust Media, Phone Calls, Ringtones & Alerts level, Notifications & Guidance level, Voice Recognition and Microphone Level for Android Auto mode.

Setting item:

Media / Phone Calls / Ringtones & Alerts / Notifications & Guidance / Voice Recognition / Microphone Level

Setting contents for Media:

-14 to +14 (Initial setting: 0)

Setting contents for Phone Calls:

1 to 35 (Initial setting: 10)

Setting contents for Ringtones & Alerts:

1 to 6 (Initial setting: 3)

Setting contents for other items:

1 to 11 (Initial setting: 5)

Adjusting the Caller Level

You can adjust the volume of the incoming call.

Setting item:

Caller Level

Setting contents:

1 to 35 (Initial setting: 10)

Adjusting the Microphone Level

You can adjust the transmit volume, during the call.

Setting item:

Microphone Level

Setting contents:

1 to 11 (Initial setting: 5)

Adjusting the Ring Tone Level

You can adjust the receive volume, during the call.

Setting item:

Ring Tone Level

Setting contents:

1 to 6 (Initial setting: 3)

Key Sound Volume Setting

You can change the volume of the sound heard when a button is touched.

Setting item:

Key Sound Feedback

Setting contents:

0 to 6 (Initial setting: 3)

Setting Audio Mute On/Off while Backing up

The sound can be muted when the shift gear lever is set to the reverse (R) position enabling you to easily hear sensors, etc., while reversing your car.

Setting item:

Mute While Backing Up

Setting contents:

Off / On (Initial setting)

Off: Does not mute.

On: Mutes when the shift gear lever is set to the reverse (R) position.

Setting the Microphone Effect

Set this item when an iPhone 5 or later/Android smartphone with Android Auto App is connected.

You can turn on or off the Microphone Effect.

This setting influences Apple CarPlay/Android Auto mode.

Setting item:

Microphone EC / NR

Setting contents:

On (Initial setting:) / Off

Default Sound Settings

You can restore the Dual HD EQ*/X-Over*/Time Correction*/MX HD Level/Rear Speaker/Subwoofer/Subwoofer Level/Subwoofer Phase to factory settings.

Setting item:

Default Sound Settings

Touch **[Set]**, and the confirmation message appears.

To initialize, touch **[OK]**.

* The setting values that are stored in Preset 1 to Preset 3 cannot be initialized.

About the Crossover

Crossover (X-Over):

This unit is equipped with an active crossover. The crossover limits the frequencies delivered to the outputs. Each channel is controlled independently. Thus, each speaker pair can be driven by the frequencies for which they have been optimally designed.

The crossover adjusts the HPF (high pass filter) or LPF (low pass filter) of each band, and also the slope (how fast the filter rolls off the highs or lows).

Adjustments should be made according to the reproduction characteristics of the speakers. Depending on the speakers, a passive network may not be necessary. If you are unsure about this point, please consult your authorized Alpine dealer.

| | Cut-off frequency (1/3 octave steps) | | Slope | | Level |
|---------------------|--------------------------------------|----------------|--------------------------|--------------------------|-------------|
| | HPF | LPF | HPF | LPF | |
| Subwoofer (LPF) | ---- | 20 Hz - 200 Hz | ---- | 0, 6, 12, 18, 24 dB/oct. | 0 to -12 dB |
| Rear speaker (HPF) | 20 Hz - 200 Hz | ---- | 0, 6, 12, 18, 24 dB/oct. | ---- | 0 to -12 dB |
| Front speaker (HPF) | 20 Hz - 200 Hz | ---- | 0, 6, 12, 18, 24 dB/oct. | ---- | 0 to -12 dB |

Low range

High range

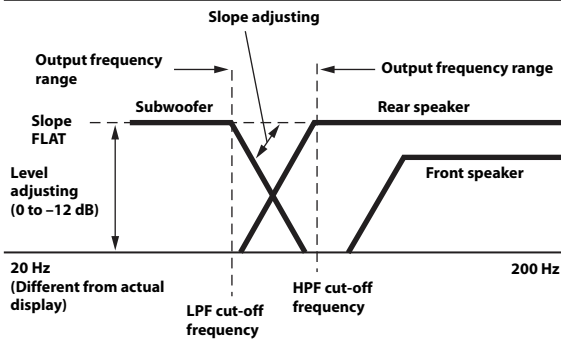

- **HPF (high pass filter):** Cuts the lower frequencies and allows the higher frequencies to pass.
- **LPF (low pass filter):** Cuts the higher frequencies and allows the lower frequencies to pass.
- **Slope:** The level change (in dB) for a frequency change of one octave.
- The higher the slope value, the steeper the slope becomes.
- Adjust the slope to FLAT to bypass the HP or LP filters.
- Do not use a tweeter without the HPF on or set to a low frequency, as it may cause damage to the speaker due to the low frequency content.
- Adjustment should be made according to the recommended crossover frequency of the connected speakers. Determine the recommended crossover frequency of the speakers. Adjusting to a frequency range outside that recommended may cause damage to the speakers. For the recommended crossover frequencies of Alpine speakers, refer to the respective Owner's Manual.

We are not responsible for damage or malfunction of speakers caused by using the crossover outside the recommended value.

About Time Correction

The distance between the listener and the speakers in a car vary widely due to the complex speaker placement. This difference in the distances from the speakers to the listener creates a shift in the sounds image and frequency characteristics. This is caused by the time delay between the sound reaching the listener's right versus the left ear.

To correct this, this unit is able to delay the audio signal to the speakers closest to the listener. This effectively creates a perception of increased distance for those speakers. The listener can be placed at an equal distance between the left and right speakers for optimum staging. The adjustment will be made for each speaker in 3.4 cm steps.

Example 1. Listening Position: Front Left Seat

Adjust the time correction level of the front left speaker to a high value and the rear right to zero or a low value.

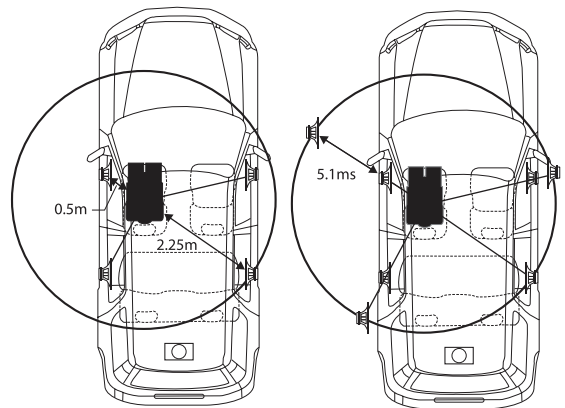

The sound is not balanced because the distance between the listening position and the various speakers is different. The difference in distance between the front left speaker and the rear right speaker is 1.75 m (68-7/8").

Here we calculate the time correction value for the front left speaker in the diagram on the above.

Conditions:

Farthest Speaker – listening position : 2.25 m (88-9/16")

Front left speaker – listening position : 0.5 m (19-11/16")

Calculation: $L = 2.25 \text{ m} - 0.5 \text{ m} = 1.75 \text{ m}$ (68-7/8")

Time correction = $1.75 \div 343^* \times 1,000 = 5.1 \text{ (ms)}$

* Speed of sound: 343 m/s (765 mph) at 20°C

In other words, giving the front left speaker a time correction value of 5.1 ms makes it seem as if its distance from the listener is the same as the distance to the farthest speaker.

Time correction eliminates the differences in the time required for the sound to reach the listening position.

The time of the front left speaker is corrected by 5.1 ms so that its sound reaches the listening position at the same time as the sound of other speakers.

Example 2. Listening Position: All Seats

Adjust the time correction level of each speaker to almost the same level.

1 Sit in the listening position (driver's seat, etc.) and measure the distance (in meters) between your head and the various speakers.

2 Calculate the difference between the distance correction value to the farthest speaker and the other speakers.

$$L = (\text{distance to farthest speaker}) - (\text{distance to other speakers})$$

These values are the time correction values for the different speakers. Setting these values to make each sound reach the listening position at the same time as the sound of other speakers.

Time Correction Value List

| Time Difference (msec) | Distance (cm) | Distance (inch) | Time Difference (msec) | Distance (cm) | Distance (inch) |
|------------------------|---------------|-----------------|------------------------|---------------|-----------------|
| 0.0 | 0.0 | 0.0 | 5.1 | 173.4 | 68.3 |
| 0.1 | 3.4 | 1.3 | 5.2 | 176.8 | 69.7 |
| 0.2 | 6.8 | 2.7 | 5.3 | 180.2 | 71.0 |
| 0.3 | 10.2 | 4.0 | 5.4 | 183.6 | 72.4 |
| 0.4 | 13.6 | 5.4 | 5.5 | 187.0 | 73.7 |
| 0.5 | 17.0 | 6.7 | 5.6 | 190.4 | 75.0 |
| 0.6 | 20.4 | 8.0 | 5.7 | 193.8 | 76.4 |
| 0.7 | 23.8 | 9.4 | 5.8 | 197.2 | 77.7 |
| 0.8 | 27.2 | 10.7 | 5.9 | 200.6 | 79.1 |
| 0.9 | 30.6 | 12.1 | 6.0 | 204.0 | 80.4 |
| 1.0 | 34.0 | 13.4 | 6.1 | 207.4 | 81.7 |
| 1.1 | 37.4 | 14.7 | 6.2 | 210.8 | 83.1 |
| 1.2 | 40.8 | 16.1 | 6.3 | 214.2 | 84.4 |
| 1.3 | 44.2 | 17.4 | 6.4 | 217.6 | 85.8 |
| 1.4 | 47.6 | 18.8 | 6.5 | 221.0 | 87.1 |
| 1.5 | 51.0 | 20.1 | 6.6 | 224.4 | 88.4 |
| 1.6 | 54.4 | 21.4 | 6.7 | 227.8 | 89.8 |
| 1.7 | 57.8 | 22.8 | 6.8 | 231.2 | 91.1 |
| 1.8 | 61.2 | 24.1 | 6.9 | 234.6 | 92.5 |
| 1.9 | 64.6 | 25.5 | 7.0 | 238.0 | 93.8 |
| 2.0 | 68.0 | 26.8 | 7.1 | 241.4 | 95.1 |
| 2.1 | 71.4 | 28.1 | 7.2 | 244.8 | 96.5 |
| 2.2 | 74.8 | 29.5 | 7.3 | 248.2 | 97.8 |
| 2.3 | 78.2 | 30.8 | 7.4 | 251.6 | 99.2 |
| 2.4 | 81.6 | 32.2 | 7.5 | 255.0 | 100.5 |
| 2.5 | 85.0 | 33.5 | 7.6 | 258.4 | 101.8 |
| 2.6 | 88.4 | 34.8 | 7.7 | 261.8 | 103.2 |
| 2.7 | 91.8 | 36.2 | 7.8 | 265.2 | 104.5 |
| 2.8 | 95.2 | 37.5 | 7.9 | 268.6 | 105.9 |
| 2.9 | 98.6 | 38.9 | 8.0 | 272.0 | 107.2 |
| 3.0 | 102.0 | 40.2 | 8.1 | 275.4 | 108.5 |
| 3.1 | 105.4 | 41.5 | 8.2 | 278.8 | 109.9 |
| 3.2 | 108.8 | 42.9 | 8.3 | 282.2 | 111.2 |
| 3.3 | 112.2 | 44.2 | 8.4 | 285.6 | 112.6 |
| 3.4 | 115.6 | 45.6 | 8.5 | 289.0 | 113.9 |
| 3.5 | 119.0 | 46.9 | 8.6 | 292.4 | 115.2 |
| 3.6 | 122.4 | 48.2 | 8.7 | 295.8 | 116.6 |
| 3.7 | 125.8 | 49.6 | 8.8 | 299.2 | 117.9 |
| 3.8 | 129.2 | 50.9 | 8.9 | 302.6 | 119.3 |
| 3.9 | 132.6 | 52.3 | 9.0 | 306.0 | 120.6 |
| 4.0 | 136.0 | 53.6 | 9.1 | 309.4 | 121.9 |
| 4.1 | 139.4 | 54.9 | 9.2 | 312.8 | 123.3 |
| 4.2 | 142.8 | 56.3 | 9.3 | 316.2 | 124.6 |
| 4.3 | 146.2 | 57.6 | 9.4 | 319.6 | 126.0 |
| 4.4 | 149.6 | 59.0 | 9.5 | 323.0 | 127.3 |
| 4.5 | 153.0 | 60.3 | 9.6 | 326.4 | 128.6 |
| 4.6 | 156.4 | 61.6 | 9.7 | 329.8 | 130.0 |
| 4.7 | 159.8 | 63.0 | 9.8 | 333.2 | 131.3 |
| 4.8 | 163.2 | 64.3 | 9.9 | 336.6 | 132.7 |
| 4.9 | 166.6 | 65.7 | | | |
| 5.0 | 170.0 | 67.0 | | | |

Language Setting

The Setup menu, feedback information, etc. for this unit can be changed to appear in the selected language.

Setting item:

Language*1 (Language*2)

Setting contents:

English / Deutsch / Français / Español /
Português / Italiano / Nederlands / Suomi /
Norsk / Svenska / Dansk / русский язык /
Slovenčina / Polski / Český / Magyar / Ελληνικά /
עברית / العربية / Türkçe / 中文 /
Bahasa Indonesia

*1 Display in the currently selected language.

*2 Always display in English.

Picture Quality Setup

[Picture Quality] is selected on the General Setup Menu screen in step 1. See "General Setup" (page 31).

You can set up items related to an image.



Settable items differ depending on the application.

[Video] (Video media)*3:

Visual EQ / Brightness / Color / Tint / Contrast / Sharpness

[Camera]*4:

Brightness / Color / Contrast

[Navigation]:

Brightness / Contrast

*3 "Video" can be selected while a video is playing.

*4 The camera names are not displayed when "Off" is set (page 45).

Selecting the Visual EQ Mode (Factory's setting)

You can select a mode suitable for the subject image.

Setting item:

Visual EQ

Setting contents:

Off (Initial setting) / Night / Soft / Sharp / Contrast

Off: Initial Setting

Night: Suitable for movies in which dark scenes frequently appear.

Soft: Suitable for CGs and animated films.

Sharp: Suitable for old movies where images are not clearly shown.

Contrast: Suitable for recent movies.

• To return to the default video settings, set this function to Off. Any Visual EQ selection or changes made are reset their initial settings.

Adjusting Brightness

Setting item:
Brightness

Setting content:
-15 to +15 (Initial setting: 0)

You can adjust the brightness between MIN (-15) and MAX (+15). When it reaches the minimum or maximum point, the display shows "MIN" or "MAX" respectively.

Adjusting Color of Picture

Setting item:
Color

Setting content:
-15 to +15 (Initial setting: 0)

You can adjust the color between MIN (-15) and MAX (+15). When it reaches the minimum or maximum point, the display shows "MIN" or "MAX" respectively.

Adjusting Tint of Picture

Setting item:
Tint

Setting content:
R15 to G15 (Initial setting: 0)

Adjust the Color from R15 to G15.

Adjusting Image Contrast

Setting item:
Contrast

Setting content:
-15 to +15 (Initial setting: 0)

You can adjust the contrast between MIN (-15) and MAX (+15). When it reaches the minimum or maximum point, the display shows "MIN" or "MAX" respectively.

Adjusting Picture Quality

Setting item:
Sharpness

Setting content:
-5 to +5 (Initial setting: 0)

Picture quality adjustment range is -5 to +5. "SOFT" and "HARD" appear as the minimum and maximum values specified.

Saving and calling the adjusted picture quality

When adjusting audio (video media), you can store the settings made for "Adjusting Brightness, Color, Tint, Contrast and Sharpness."

Setting item:
Preset 1 / Preset 2

1 After completing "Adjusting Brightness, Color, Tint, Contrast and Sharpness" (page 38), touch and hold [Preset 1] or [Preset 2] to save the settings.

2 Touch [Preset 1] or [Preset 2] to call the saved settings.

Display/Key Setup

[Display/Key] is selected on the General Setup Menu screen in step 2. See "General Setup" (page 31).

You can set up the brightness, color, display, etc., of the screen.

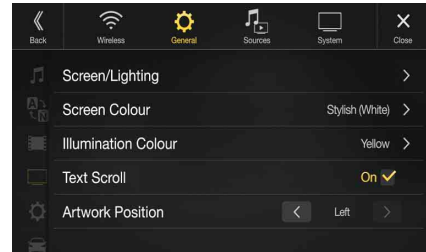

Screen/Lighting Customize

1 Touch [Screen/Lighting] in the Display/Key Setup Menu screen.

The Screen/Lighting setup screen appears.

Setting item:
Dimmer / Key Illumination Level / Screen Dimmer Level

Setting the Brightness of the Backlighting

Backlighting is provided by LEDs light built into the liquid crystal panel. The illumination control adjusts the brightness of the backlighting based on the car ambient lighting for easier viewing.

Setting item:
Dimmer
Setting contents:
Auto (Initial setting) / On / Off

- Auto:** Adjust the brightness of the background illumination of the monitor automatically to the brightness of the car interior.
- On:** Keep the background illumination of the monitor dark.
- Off:** Deactivate Auto Dimmer mode to keep the background illumination of the monitor bright.

- When "On" is set, the setting is also applied for the button lighting in "Adjusting the Dimmer of Button Lighting at Night" (page 38), and "Adjusting the Minimum Level of Backlight" (page 39).

Adjusting the Dimmer of Button Lighting at Night

You can adjust the brightness of the button lighting at night with the dimmer.

Setting item:
Key Illumination Level
Setting level:
-2 to +2 (Initial setting: 0)

- This setting is only available when "Dimmer" is set to "On" or "Auto."

Adjusting the Minimum Level of Backlight

You can adjust the brightness of the backlight. This function could be used, for instance, to change the screen brightness while traveling at night.

Setting item:

Screen Dimmer Level

Setting contents:

-15 to +15 (Initial setting: 0)

You can adjust the level between MIN (-15) and MAX (+15). When it reaches the minimum or maximum point, the display shows "MIN" or "MAX" respectively.

- This setting is only available when "Dimmer" is set to "On" or "Auto."

Switching the Display Color (X308U/INE-W987HD only)

You can choose from 8 different display colors.

Setting item:

Screen Color

Setting contents:

Glass Blue / Glass Green / Glass Light Blue / Glass Red / Steel White / Steel Green / Steel Light Blue / Steel Red

Switching the Illumination Color (X308U/INE-W987HD only)

You can choose the color of the Front Panel button from one of 7 colors.

Setting item:

Illumination Color

Setting contents:

Blue (Initial setting) / Light Blue / Aqua / Red / Green / Amber / Yellow

Setting the Display Color (Off-Road on/off) (X409 only)

You can select what display color (background image and menu theme) to display for Off-Road on and off modes individually. There are 8 different display colors to choose from.



Setting item:

Screen Color

Setting contents:

Street Blue / Street Green / Street Light Blue / Street Red / Off-Road White / Off-Road Green / Off-Road Light Blue / Off-Road Red

- The initial setting for Off-Road on mode is "Off-Road Green", and for Off-Road off mode is "Street Green".

Setting the Text Scroll

Scroll display is available if folder name, file name or tag information is entered.

Setting item:

Text Scroll

Setting contents:

Off (Initial setting) / On

Off: Turns off the scroll mode.

On*: Turns on the Auto scroll mode. Scroll display is repeated as long as the mode is turned on.

- * The text scroll is not available while driving.

Switching the Artwork Position

You can set the artwork position to the center or the left.

Setting item:

Artwork Position

Setting contents:

Center / Left (Initial setting)

General Setup

[General] is selected on the General Setup Menu screen in step 1. See "General Setup" (page 31).

You can set up items related to the language, etc.



Format settings

The character code to be used for tag text information displayed on the screen can be selected from 7 character codes.

Setting item:

Format

Setting contents:

Latin-1 / Latin-9 (Initial setting) / Russian / Chinese / Thai / Arabic / Hebrew

Latin-1: ISO 8859-1

Latin-9: ISO 8859-15

Russian: ISO 8859-5

Chinese: GB18030-2005

Thai: CP874

Arabic: CP1256

Hebrew: CP1255

About X409/X308U/INE-W987HD

[**About**] enables you to check the Serial No., Firmware Version, Model Name, and to initialize various settings.

Displaying the Product Information

You can view the version information of this product. Make note of this information and refer to it whenever you contact Alpine Tech Support or an Alpine-authorized dealer.

Setting contents:

Serial No. / Firmware Version / Model Name

Initializing the System

You can initialize all data, to restore the factory settings. Remove the USB flash drive, etc. from the system before operation

Setting item:

Clear All Settings

- 1 Touch [Reset] of "Clear All Settings."**
- 2 After the confirmation message appears, touch [OK].**
The confirmation screen appears again.
- 3 Touch [OK].**
The system starts initialization.

- Do not turn on/off the power, change the ignition key position or remove the screen panel until system restart is completed.

Setting Demo mode to Off/On

This unit has a Demonstration feature for the display. If the unit is in Demo mode, set Demo mode to OFF to turn it OFF.

Setting item:

Demo mode

Setting contents:

Off (Initial setting) / On

- If you perform an operation during the Demo mode, the demonstration is temporarily stopped.

Off-Road SWRC Settings (X409 only)

Two operations can be assigned to the SWRC SOURCE button.

Setting item: (only available when Off-Road Mode is turned on)

Off-Road SWRC Settings

Setting contents:

Source / Camera (Initial setting)

- | | |
|---------|---|
| Source: | Pressing the [Source/Camera View] button once will change the radio source. |
| Camera: | Pressing the [Source/Camera View] button once will activate camera mode. |
- When camera mode is activated pressing the [Source/Camera View] button once will cycle the camera view mode (Panorama/Back/Top/Corner), if an Alpine multi-view camera is connected.
 - When the Alpine multi-camera selector (KCX-C250MC) is connected pressing and holding the [Source/Camera View] button for at least 2 seconds will cycle the camera source (Front Camera/Rear Camera/Side Camera).
 - Off-Road Steering Wheel Remote Control (SWRC) settings are applicable to vehicles with steering wheel media buttons. This setting is assigned to the [Source/Camera View] button, located between Volume + / Volume - on the back right side of the steering wheel.

Vehicle Setup

[**Vehicle**] is selected on the General Setup Menu screen in step 1. See "General Setup" (page 31).

Steering wheel Setting

Set this item when an iPhone 5 or later/Android smartphone with Android Auto App is connected.

This setting influences Apple CarPlay/Android Auto mode.

Setting item:

Steering wheel

Setting contents:

Left (Initial setting) / Right

Installation Setup

Vehicle Setup enables you to check the installation status of Reverse Lead/Parking Brake Lead/Speed Signal/GPS Status/GPS Reception/VP Learning/Sensor Diagnosis, etc.

Setting item:

Installation Status

The Installation check screen is displayed.

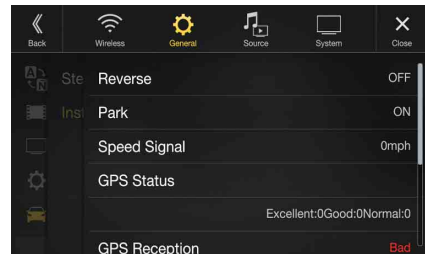

- Depending on your vehicle, some installation status may not be checked via this function.

Inclinometer Setup (X409 only)

You can set the Inclinometer (Roll/Pitch) alarm angle preferences. The alarm displays visually in the Off-Road vehicle information interface on the Off-Road Navi screen and Off-Road Camera screen. The angle display changes from green to yellow for Low Alarm, then to red for High Alarm.

Setting item: (only available when Off-Road Mode is turned on)

Inclinometer

Setting contents:

Roll Low Alarm: 0 ~ 84 (initial setting: 30)
Roll High Alarm: 0 ~ 85 (initial setting: 40)
Pitch Up Low Alarm: 0 ~ 89 (initial setting: 40)
Pitch Up High Alarm: 0 ~ 90 (initial setting: 60)
Pitch Down Low Alarm: 0 ~ -89 (initial setting: -40)
Pitch Down High Alarm: 0 ~ -90 (initial setting: -60)

- The upper limit alarm value must be greater than lower limit alarm value.

Source Setup

[Source] is selected on the Setup main screen in step 3. See “Setup Operation” (page 28).

■ Source Setup Menu screen



<Setting items>

| |
|---------------------|
| Radio |
| FM Tuner Setting |
| FM Frequency Step |
| SiriusXM*1 |
| Alert Setup |
| Alert |
| Alert Delete All |
| Favorite Team Setup |
| Parental Lock |
| Signal Indicator |
| AUX*2, 5 |
| AUX Name*3 |
| Signal*3 |
| HDMI*4 |
| Bluetooth Pandora |

*1 This setting can be set when the SiriusXM source is being selected.

*2 This setting cannot be changed while the AUX source is being selected.

*3 This setting is only available when “AUX” is set to “On” (☑).

*4 This setting cannot be changed while the HDMI source is being selected.

*5 This setting cannot be set when the iDataLink module (sold separately) is connected.

*6 This setting cannot be adjusted when an iPod/iPhone is connected or Apple CarPlay/iPod/Pandora source is being selected.

The following steps 1 to 3 are common to each “Setting item” of Source Setup. See each section for details.

1 Select the desired item.

2 To switch the setting, touch [<], [>], [+], [-], or mark the checkboxes “Off” (☐) or “On” (☑).

- If “>” appears, there is a further hierarchy. Touch the desired item.

3 Touch [X] to return to the main source screen.

- To return to the previous List screen, touch [<<] in the previous page. For details, see “About Basic Operation for List Screen” (page 18).

Radio Setup

[Radio] is selected on the Source Setup Menu screen in step 1. See “Source Setup” (page 41).

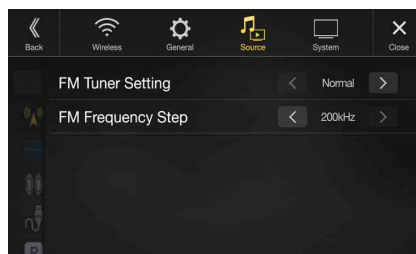

Setting the TUNER (FM) Tone Quality (Tuner Condition)

This unit can set your preferred tone quality for FM radio source.

Setting item:

FM Tuner Setting

Setting contents:

Normal (Initial setting) / HiFi / Stable

Normal: Standard setting

HiFi: High-quality setting

Stable: Control noise

- Noise may be more noticeable when HiFi is set, depending on the reception status. In this case, the Normal setting is recommended.

Setting the TUNER (FM) Frequency Step

During manual tuning, you can select the frequency step for FM analog radio station searching.

Setting item:

FM Frequency Step

Setting contents:

200kHz (Initial setting) / 100kHz

SiriusXM Setup

[SiriusXM] is selected on the Source Setup Menu screen in step 1. See “Source Setup” (page 41).

The following operations can be performed to manage the stored Songs, Artists and Sports Teams information. (To learn about how to store the information, see “Storing the desired Song/Artist” on page 67 and “Setting the Favorite Sports Team Alerts” on page 42.)

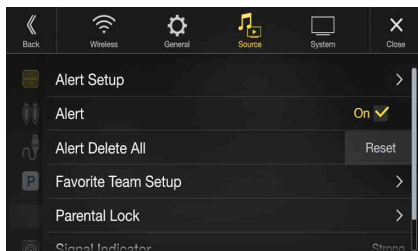

Setting the Alert individually for an Artist/Song/Favorite Team

This menu option allows you to enable the Artist/Song/Team alert for individual Artists/Songs/Teams (On or Off) or to delete individual stored Artist/Song/Team alerts (Delete).

Setting item:

Alert Setup



Set to “On” (☑) to enable the alert for the Artist/Song or Team.
Set to “Off” (☐) to disable the alert for the Artist/Song or Team.

- To delete the list, touch [🗑️] (Delete), and then touch [OK].

Setting ON/OFF of all Songs/Artists/Games Alert

This menu option allows you to temporarily disable the Artist/Song/Game Alerts for all Artists/Songs/Games. When the Alerts are re-enabled, individual Artist/Song/Game Alert disabled in the Alert List menu setting remain disabled.

Setting item:

Alert

Setting contents:

On / Off

If “On” (☑) is set, the alert for all stored Artists/Songs/Games is enabled.

If “Off” (☐) is set, the alerts for all stored Artists/Songs/Games are disabled.

Deleting all stored Alert

This operation will delete all alerts (artists, songs and teams) stored in memory.

Setting item:

Alert Delete All

1 Touch [Reset] of “Alert Delete All”

A message is displayed.

2 Touch [OK] to clear the information of all stored Artist, Song, and Game alert items.

Touch [Cancel] to cancel.

Setting the Favorite Sports Team Alerts

This menu option allows you to select your favorite teams, organized by leagues, so that you will be alerted later when your favorite teams are playing on other channels. Once selected, you will be alerted when games that those teams are playing in can be heard on a SiriusXM channel.

Setting item:

Favorite Team Setup

Setting contents:

On / Off

1 Touch [Favorite Team Setup].

A sports league list is displayed.

2 Select the desired league.

The display changes to the team list of the selected league.

3 Touch the checkboxes on the Team list to set teams to “☑” (registered) or “☐” (released).

- When “☑” (registered) is set, scrolling text of the Team name, Total registrations, and Remaining number of registration slots is displayed for two seconds, then the team is registered as a Favorite Team.
- When you set a team that is registered as an Alert to “☐” (released), scrolling text for confirmation is displayed. Touch [OK] to cancel the registration.
- The maximum number of registered Teams, Artists, and Songs is 50. For details on how to register an Artist alert or Song alert, see “Storing the desired Song/Artist” (page 67).

When the number of registered Teams, Artist, and Songs exceeds 50

If the total number of registered Teams, Artists, and Songs is already at 50 when “☑” (registered) is set, then scrolling text is displayed, asking whether you want to replace a registered Artist/Song/Team with the new one. If you want to replace one, go to step 4.

4 Touch [OK].

The list of registered Artists/Songs/Teams is displayed.

- If you want to cancel the registration of your Favorite Team, then touch [Cancel], and return to step 3.

5 Touch the Artist, Song, or Team name that you want to replace.

Scrolling text of the Team name, Total registrations, and Remaining number of registration slots is displayed for 2 seconds, then the team is registered as a Favorite Team.

- For details on deleting a registered Artist, Song, or Team beforehand, to secure a registration slot in advance, see “Setting the Alert individually for an Artist/Song/Favorite Team” (page 42).

Setting the Parental Lock

You can lock out channels with passcode protection. Channels that are locked cannot be accessed without entering the passcode. You can unlock a channel or change the passcode using this menu option.

Setting item:

Parental Lock

- 1 Touch [Parental Lock].**
A passcode input screen is displayed.
- 2 Touch the numeric keypad to input a 4-digit passcode.**
The initial default 4-digit passcode is set to 0000. After entering the digit, it is displayed as "*" (asterisk).
 - Touch [] to delete an entered number.
 - Touch [Delete All] to delete all entered numbers.
- 3 Touch [Enter].**

Setting the Lock status of individual channels

- 4 Touch [Locked Channels].**
The channels list screen is displayed.
- 5 Touch the checkboxes "On" () or "Off" () of the channels list to set the Parent Lock Off/On.**

Clearing the Lock of ALL the locked Channels

- 4 Touch [Clear All Locked Channels].**
- 5 Touch [OK] to clear the lock of all the locked channels.**
Touch [Cancel] to cancel.

Changing the Lock Passcode

- 4 Touch [Edit Code].**
The numeric keypad screen is displayed.
- 5 Use the keypad to enter the current (old) 4-digit passcode.**
The initial passcode is set to 0000.
 - Touch [] to delete an entered number.
 - Touch [Delete All] to delete all entered numbers.
- 6 Touch [Enter] to confirm the entry.**
- 7 Now use the keypad to enter the new 4-digit passcode.**
- 8 Touch [Enter].**
- 9 Then use the keypad to enter the new 4-digit passcode a second time to verify it.**
- 10 Touch [Enter].**
 - Remember to keep a note of the passcode in a safe place in case you forget the code.

Signal Strength Information

While listening to a SiriusXM Channel, the Signal strength of the current channel will be displayed.

Setting item:

Signal Indicator

This menu item displays the SiriusXM signal strength as Strong, Good, Weak or No Signal.

- If the Signal Indicator reports Weak or No Signal and your vehicle is parked outside with no obstructions to the southern sky, then your SiriusXM antenna may not be properly installed or may have become damaged.

AUX Setup

[AUX] is selected on the Source Setup Menu screen in step 1. See "Source Setup" (page 41).

You can set up the items related to the Auxiliary device.

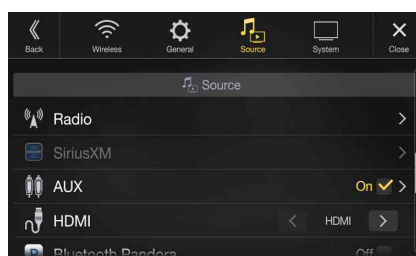

Setting item:

AUX

Setting contents:

Off / On (Initial setting)

Off: AUX source is not displayed.

On: AUX source is displayed.

■ Usable 4-pole mini AV plug

The unit accepts the following 4-pole mini AV plug pin-out:

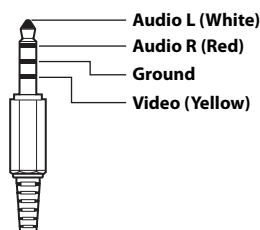

- Please check pin-out carefully before use of this product. Depending on the cable, there may be no picture and/or sound.

Setting the Auxiliary (AUX) Name

Make sure the AUX is set to "On" (). See "AUX Setup" (page 43).

Setting item:

AUX Name

Setting contents:

AUX (Initial setting) / AUX DVD / GAME / External DVD / DVD Changer* / DVB-T* / TV*

* Not used for this unit.

Switching the Visual Input Signal System

You can make this setting only when AUX is set to “On” (☑). See “AUX Setup” (page 43).

Setting item:

Signal

Setting contents:

Auto (Initial setting) / NTSC/PAL

Auto: The video input signal type (NTSC or PAL) will be automatically selected.

NTSC/PAL: Choose the video input signal type manually.

HDMI Setup

[HDMI] is selected on the Source Setup Menu screen in step 1. See “Source Setup” (page 41).

You can set the name of an external device connected via HDMI.



Setting item:

HDMI

Setting contents:

HDMI (HDMI 1*) (Initial setting) / DVD

HDMI: Set when a smartphone is connected via HDMI.

(HDMI 1):

DVD: Set when an external DVD player is connected.

* When the HDMI selector is set to “On,” “HDMI 1” is displayed in the Setting contents. For details on setting the HDMI selector, see “Setting the HDMI Selector On/Off” (page 48).

Setting the Bluetooth Pandora®

[Bluetooth Pandora] is selected on the Source Setup Menu screen in step 1. See “Source Setup” (page 41).

To use Bluetooth Pandora, set the Bluetooth Pandora setting to “On.”

Setting item:

Bluetooth Pandora

Setting contents:

Off / On (Initial Setting)

- When “On” is set, the Bluetooth Pandora® source is displayed on the Menu screen.
- When the current source is Bluetooth Pandora, this setting cannot be adjusted.

System Setup

[System] is selected on the Setup main screen in step 3. See “Setup Operation” (page 28).

System Setup Menu screen

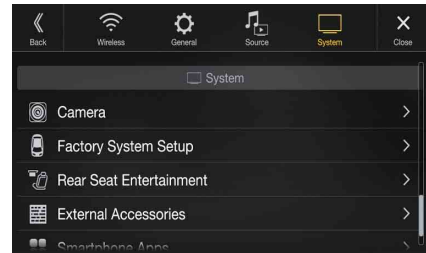

<Setting items>

| | |
|-------------------------|---------------------------------|
| Camera*1 | Camera Select |
| | Camera Signal*2 |
| | Guide Adjustment*3 |
| | Camera Interrupt (Power Mode)*4 |
| Factory System Setup | USB/iPod / SiriusXM |
| | Default Vehicle Screen |
| | Maestro Module |
| Rear Seat Entertainment | Rear Seat Entertainment |
| | Remote Sensor |
| External Accessories | External Audio Processor |
| | HDMI selector |
| | External Accessory Ctrl |
| Smartphone Apps | Alpine TuneIt App*5 |

*1 When you select “Camera Selector” in “Camera Select”, the setting item is different. For details, see “Setting Multi Camera to On/Off” (page 47).

*2 When Camera Select is set to “Off”, you cannot select this item.

*3 You can select this item only when Camera Select is “Front” or “Rear.”

*4 You can select this item only when Camera Select is “Rear.”

*5 Set this setting after closing the Alpine TuneIt App.

The following steps 1 to 3 are common to each “Setting item” of System Setup. See each section for details.

- 1 Select the desired item.
- 2 To switch the setting, touch [⟨], [⟩], [+], [–], or mark the checkboxes “Off” (☐) or “On” (☑).
 - If “>” appears, there is a further hierarchy. Touch the desired item.
- 3 Touch [×] to return to the main source screen.
 - To return to the previous List screen, touch [⟨] in the previous page. For details, see “About Basic Operation for List Screen” (page 18).

Camera Setup

[Camera] is selected on the System Setup Menu screen in step 1. See “System Setup” (page 44). You can set up items related to the Camera.



Setting the Camera Input

Setting item:

Camera Select

Setting contents:

Off (Initial setting) / Front / Rear / Other / Camera Selector

Front: Front camera

Rear: Rear camera

Other: Side camera, Room camera, etc.

Camera Selector*: Front Camera/Rear Camera/Side Camera connected to the optional Multi Camera Interface module.

* When selecting Camera Selector, you can set the Front Camera/Rear Camera/Side Camera to On/Off. For details, see “Setting Multi Camera to On/Off” (page 47).

Setting the Camera Signal Input

When the camera is connected, the video input signal type can be chosen.

Further setting item:

Camera Signal

Setting contents:

NTSC (Initial setting) / PAL

Switching Video Source for Multi View Camera

The video source can be changed when connected to Multi View Camera.

When Camera Select is set to “Off” or “Other,” you cannot select this item.

Setting item:

Guide Adjustment

1 Touch [Guide Adjustment].

The camera guide adjustment screen is displayed.

Multi View compatible Side Camera

2 Touch [Front] or [Rear].

The view will change to the selected view.

Multi View compatible Front Camera/Rear Camera

2 Touch [Back], [Panorama], [Corner], or [Top].

The view will change to the selected view.

- [Back] will not appear for the Front camera.

- For an explanation of video patterns, see the camera Owner’s Manual.

Adjusting the Rear/Front/Side Camera Guide

You can adjust the camera guide position.

Setting item:

Guide Adjustment

1 Touch [Guide Adjustment].

The camera guide adjustment screen is displayed.

- If the video pattern is set to “Corner (Rear/Front Camera only),” the camera guide will not be displayed.
- When you connect a Multi View compatible camera, select a Video Pattern to make a guide adjustment.
- To adjust the guide position of the Rear Camera, touch [Hitch Guide On] or [Hitch Guide Off] to display/hide the Hitch Guide. You can adjust the Hitch Guide to mark the position of the junction between your vehicle and your trailer.
- When you connect a Multi View compatible Side Camera, after selecting the Video Pattern, touch [Left steering] or [Right steering] to make the guide adjustment that matches the position of the steering wheel in your vehicle.

2 Touch [Adjust].

- If [Adjust] does not appear, proceed to step 3.

3 Touch the guide you intend to adjust.

Guide line can also be selected by touching [▼] [▲].

■ Rear Camera screen example

When Hitch Guide is set to Off

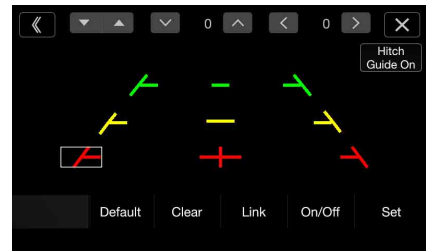

- You cannot adjust the position of the yellow guide line “—” in the center independently. It is controlled by a system to be the center of the two yellow guide lines “—” and “—” on the left and right, or the central green line “—” and red guide line “—”.

When Hitch Guide is set to On

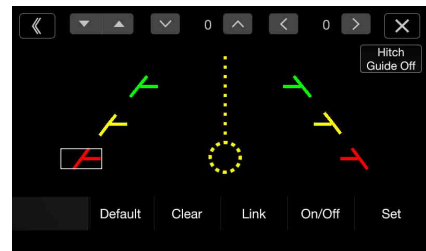

- You can adjust the Hitch Guide to mark the position of the junction between your vehicle and your trailer.

■ Front Camera screen example

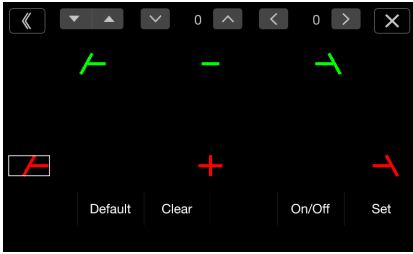

■ Side Camera screen example

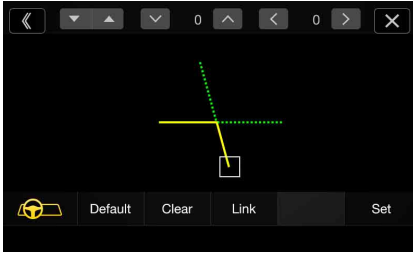

4 Touch [∨], [∧], [⟨] or [⟩] to adjust the position of the guide.

- Touching [Clear] clears adjustments and returns to the setting before guide line alteration.

5 After the adjustment is completed, touch [Set].

Adjusting Guides Simultaneously (for Rear/Side Camera only)

<Rear Camera>

1 Touch [Link].

The 3 vertical guides of the currently-selected guide link together, allowing them to be adjusted simultaneously.

■ When Hitch Guide is set to Off

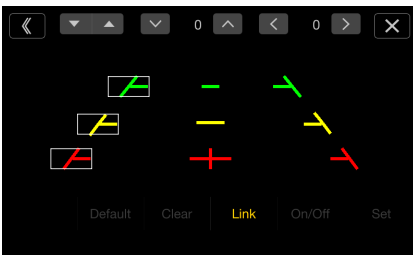

- Note on the yellow guide line “—” in the center
The yellow guide line “—” in the center is controlled by a system that locates it in the center of the two yellow guide lines, “∨” and “∧” on the left and right, or the green line “—” on the top and red guide line “+” below. Therefore you cannot move it manually.

■ When Hitch Guide is set to On

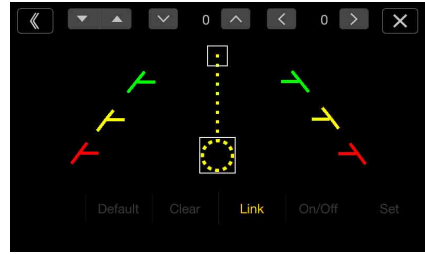

<Side Camera>

1 Touch [Link].

The 2 vertical guides of the currently-selected guide link together, allowing them to be adjusted simultaneously.

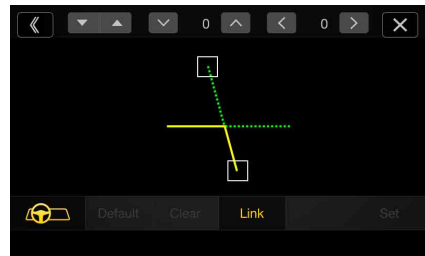

Turning Guide Display On/Off (Rear/Front Camera only)

Turning the selected guide off.

1 Touch [On/Off].

The currently selected guide will turn off.

2 To turn the guide on, touch [On/Off] again.

- Guides that are turned off are still adjustable.

Returning Guides to Default

1 Touch [Default].

A message window will appear.

2 Touch [OK].

Adjusted values will return to default settings.

Camera Interrupt Setting (Power OFF Mode) (Rear Camera Only)

You can set whether to display the rear camera image when the gear lever is moved to the reverse (R) position while the unit is turned off. You can select this item only when Camera Select is “Rear.”

Setting item:

Camera Interrupt (Power Mode)

Setting contents:

On (Initial setting) / Off

On: The rear camera image is displayed

Off: The rear camera image is not displayed

Setting Multi Camera to On/Off

When connecting the optional Multi Camera Interface module, you can connect up to 3 cameras as Front Camera/Rear Camera/Side Camera.

- When using the optional Multi Camera Interface module, select "Camera Selector" to set the "Front Camera /Rear Camera/Side Camera" to "On" (☑)/"Off" (☐).



Setting item:

Front Camera / Rear Camera / Side Camera / Default Camera*

Setting contents:

Off (Initial setting) / On

| | |
|--------------------------------|--|
| Camera Signal: | See "Setting the Camera Signal Input" (page 45) |
| Guide Adjustment: | See "Adjusting the Rear/Front/Side Camera Guide" (page 45) |
| Camera Interrupt (Power Mode): | See "Camera Interrupt Setting (Power OFF Mode) (Rear Camera Only)" (page 46) |

* You can change the Default Camera only when you set more than one camera for Front Camera/Rear Camera/Side Camera to "On." For details, see "Setting a Default Camera" (page 47).

Setting a Default Camera

When connecting an optional Multi View Camera, you can set which camera image is displayed when you touch the Camera button on the Menu screen or press the  (CAMERA) button (X409 only).

Setting item:

Default Camera

Setting contents:

Front / Rear / Side

- The initial setting differs depending on the cameras set to "On" in "Setting Multi Camera to On/Off."

Factory System Setup

[Factory System Setup] is selected on the System Setup Menu screen in step 1. See "System Setup" (page 44).



Setting the Source Category

You can set whether the following source icon in the Menu screen is available.

Setting item:

USB/iPod (Initial setting: Both) / SiriusXM (Initial setting: Aftermarket)

Setting contents:

Both / Factory / Aftermarket

| | |
|--------------|--|
| Both*: | Both the sources listed above from this unit and iDataLink module are available. |
| Factory: | Only the source listed above from iDataLink module is available. |
| Aftermarket: | Only the source listed above from this unit is available. |

* USB/iPod only.

- The iDataLink source icons not displayed on the Menu screen when no iDataLink module is connected even though "Both" or "Factory" is set.
- You cannot set the source that is currently being played.

Setting the Default Vehicle Screen

Press and hold the ★ (Favorite) button for at least 2 seconds or touch the Menu screen (page 21) to display the Info mode screen, and then set the following.

Setting item:

Default Vehicle Screen

Setting contents:

Climate / Vehicle Info. / Gauges / Parking Assist / Last mode (Initial setting)

- Depending on the car, some setting contents or this setting item may not be displayed.

Setting the Maestro Module

You can change the setting of the connected iDataLink module.

Setting item:

Maestro Module

- Depending on the iDataLink module, the setting contents may differ.

Rear Seat Entertainment Setup

[Rear Seat Entertainment] is selected on the System Setup Menu screen in step 1. See “System Setup” (page 44).

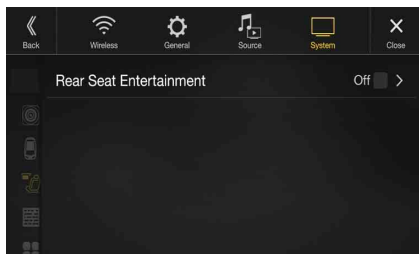

When a Rear monitor equipped with HDMI input is connected to this unit, change this setting to “On.” You can output images to the Rear monitor. For details, see “Rear Seat Entertainment Function” (page 20).

Setting item:

Rear Seat Entertainment

Setting contents:

Off (Initial setting) / On

Setting the Rear Seat Entertainment System

Make sure the Rear Seat Entertainment is set to “On” (☑). See “Rear Seat Entertainment Setup” (page 48).

Setting item:

Plasmacluster/Illumination Color

Setting contents:

Off (Initial setting) / On

- For details on adjusting Plasmacluster/Illumination, see “Rear Seat Entertainment Function” (page 20).
- When the Rear Seat Entertainment setting is set to “Off,” you cannot select this item.
- Set the coordination color and Plasmacluster controls on the Rear monitor to “Navi.” When set to “Rear monitor,” you cannot operate them from this unit.

Remote Sensor Setting

Make sure the Rear Seat Entertainment is set to “On” (☑). See “Rear Seat Entertainment Setup” (page 48).

For remote control operation, the remote sensor of the external device (Rear monitor, etc.) can be switched, as you prefer.

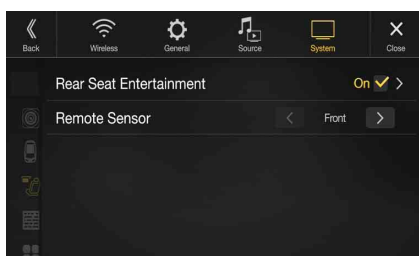

Setting item:

Remote Sensor

Setting contents:

Front (Initial setting) / Rear

Front: The remote sensor of this unit is effective.

Rear: The remote sensor of Rear monitor is effective.

- You can also control this setting from the Rear Seat Entertainment System Setup screen. For details, see “Rear Seat Entertainment Function” (page 20).

External Accessories Setup

[External Accessories] is selected on the System Setup Menu screen in step 1. See “System Setup” (page 44).



Setting the External Audio Processor

When using an external audio processor, set to “On” (☑).

Setting item:

External Audio Processor

Setting contents:

Off (Initial setting) / On

- When this setting is “On,” the Volume level is fixed at 10. Also, Balance/Fader/Subwoofer Level/Subwoofer Phase/Bass/Treble/MX HD/EQ Presets/Dual HD EQ/X-Over/Time Correction/Defeat/Phone Speaker/Default Sound Settings are set to “Off” or “Flat” and cannot be adjusted.
- Use the External Audio Processor to adjust volume.

Setting the HDMI Selector On/Off

If you connect an HDMI selector, you can connect two HDMI devices. When using an HDMI selector, set to “On” (☑).

Setting item:

HDMI selector

Setting contents:

Off (Initial setting) / On

- For details on switching the HDMI source when two HDMI devices are connected, see “HDMI Operation” (page 75).

Setting the External Accessory Control

When you have connected the optional External Accessory Control module, set this setting to “On” to turn the headlights ON/OFF or adjust the air suspension from this unit.

Setting item:

External Accessory Ctrl

Setting contents:

Off (Initial setting) / On

- When set to “On,” the [Ext Acc Ctrl] icon is displayed on the Menu screen.
- For details on the External Accessory screen and its operation, see “External Accessory Control Operation” (page 96).

Smartphone Apps Setup

[**Smartphone Apps**] is selected on the System Setup Menu screen in step 1. See “System Setup” (page 44).



Set Alpine TuneIt App to USB (iPhone) when an iPhone is connected, or set to Bluetooth (Android) when an Android Smartphone is paired.

Setting item:

*Alpine TuneIt App**1

Setting contents:

*Off / USB (iPhone) (Initial setting) / Bluetooth (Android)**2

Off: No Smartphone is connected.

USB (iPhone): When an iPhone is connected to the unit's USB port, you can program the unit's sound tuning parameters, or communicate with SNS.

Bluetooth (Android): Set this when an Android Smartphone is paired with this unit via Bluetooth technology. And after Bluetooth Audio is connected, you can program the unit's sound tuning parameters, or communicate with SNS.

- For this function to work properly, specific applications must be installed on your Smartphone before connection. Consult your Alpine dealer or the Alpine website for details.
- Only the iPhone and certain Android Smartphones support this function.

*1 Set this setting after closing the Alpine TuneIt App.

*2 Not displayed when Bluetooth is set to Off. For details, see “Bluetooth Setup” (page 29).

Apple CarPlay (Optional)

Apple CarPlay is a smarter, safer way to use your iPhone in the car. Apple CarPlay takes the things you want to do with your iPhone while driving and puts them right on the unit. You can get directions, make calls, send and receive messages, and listen to music, all in a way that allows you to stay focused on the road. Just plug in your iPhone to the unit and go.

- Before using this function plug in your iPhone using Lightning to USB Cable (Supplied with iPhone) to the unit.
- Some functions may not be available while driving.
- About iPhone models usable with this unit, see "iPod/iPhone (Optional)" (page 58). Only an iPhone 5 or later compatible with Apple CarPlay function.

Access to Apple CarPlay

1 Press the MENU button.

The Menu screen is displayed.

2 Touch [Apple CarPlay].

The Apple CarPlay mode is activated.

Touch the desired App icon on the unit, or use Siri function by pressing  or VOICE button.

- When an iPhone 5 or later is reconnected, the pop-up message-“Apple CarPlay connected.” may be displayed, touch it within 5 seconds to access to Apple CarPlay screen, or you can ignore prompt by touching [X] on the top right.
- The App must be Apple CarPlay compatible in order to appear in the Home screen.

Android Auto (Optional)

What is Android Auto

Android Auto is designed to make it easier to use apps from your phone while you're on the road. Navigate with Google Maps, listen to playlists or podcasts from your favorite apps, and more.

Activate Android Auto

Download the Android Auto App from the Google Play store before continuing.

Just plug in your smartphone to the unit's USB connector, then follow the prompt to pair your smartphone with the unit.

- The connected smartphone with Android Auto will disconnect other phone's Bluetooth connection and pair to the unit.

1 Press the MENU button.

The Menu screen is displayed.

2 Touch [Android Auto].

The Android Auto screen is displayed.

- When a used smartphone is reconnected, touch the pop-up message-“Android Auto connected” within 5 seconds to access to Android Auto screen, or you can ignore prompt by touching [X] on the top right.
- You can make a call, use voice recognition function and Android Auto's compatible navigation app, etc..
- Only Google approved apps with necessary driver-safety measures in place can be used.

Radio/HD Radio™/ RBDS

The unit can receive HD Radio broadcasting signals based on digital radio broadcast standards, in addition to analog radio broadcasts using RBDS.

HD Radio broadcasting signals are broadcast in the service areas of the current AM/ FM broadcasters where they provide digital audio distribution and data services. This unit receives the above digital broadcasts for your high-quality sound enjoyment.

Depending on the signal strength in TUNER mode, the unit will automatically switch between digital signals if they can be received, and analog radio using RBDS if digital signals cannot be received. For details, please see “Switching between Digital and Analog,” “Forced Analog Mode.”

- RBDS mode is only available during FM broadcast reception.

This unit is able to receive signals based on the terrestrial digital radio broadcasting standard.

When current AM/FM broadcasters are transmitting digital audio and data services, HD Radio broadcasting signals are on-the-air in their service area. You can receive their digital broadcast and enjoy high quality sound.

If there is no HD Radio broadcasting signal in the current area, after 10 seconds, this unit will switch to receive the RBDS Radio signal automatically. However, the display is still HD Radio Technology mode screen.

■ HD Radio main screen example

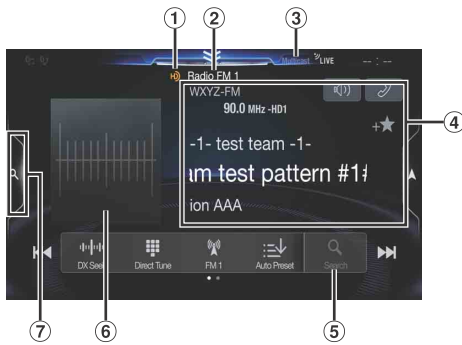

Function mode



- ① HD Radio Indicator *1
- ② Band display
Displays the band of the signal currently being received.
- ③ Multicast Indicator*2
Lights during multicast reception.

- ④ Info area
RBDS
Station Info. mode:
Program Type /Frequency and PS Name/Artist Name/Song Name/Album Name
Radio Text mode:
Frequency/ Radio Text
 - For details on switching the display of the Radio text, see “Displaying Radio Text (RBDS FM Radio mode only)” (page 53).
 HD Radio Technology
Station Info. mode:
Short Station Name/Frequency/Artist Name/Song Name/ Album Name
- ⑤ Program Type list button (RBDS FM Radio mode only)
Touch when you use the Program Type list screen.
- ⑥ Artwork etc./Station Logo display*1
- ⑦ Preset mode button
Touch when you use the Preset mode screen.

*1 HD Radio™ mode only.

*2 Lights during multicast reception. (Displays the LIVE Indicator when the Ballgame Mode is set to “On”.)



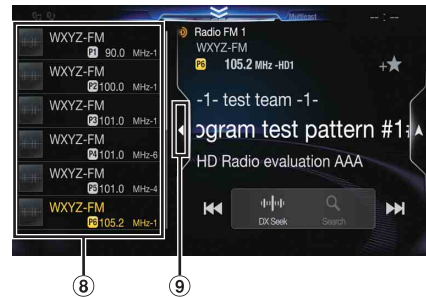

■ Preset mode screen example









- ⑧ Preset button
Swipe vertically in the list to change pages.
- ⑨ Touch to close Preset mode screen

Radio Basic Operation







Listening to the Radio

- 1 Press the  (AUDIO) button to select radio mode.**
The display shows the radio mode screen.
 - You can select and change the source from the Menu screen (page 21) or the Favorite screen (page 24).
- 2 Touch .**
The radio band select pop up screen is displayed.
 -  button displays the current selected band. (e.g. [FM1])
- 3 Select the desired band from FM1/FM2/AM.**
- 4 Touch .**
The tuning mode selection popup is displayed.
 -  button displays the current selected mode. (e.g. [DX Seek])
- 5 Touch the desired tuning mode.**
The radio frequency up or down button changes depending on the tuning mode.

| DX Seek | Local Seek | D.DX Seek | D.Local Seek |
|---|---|---|---|
|  |  |  |  |
| Manual | Program Type | | |
|  |  | | |

 - There are two modes you can select for auto tuning, DX and Local:
 - DX Seek (Distance) mode*;
Both strong and weak stations will be tuned in.
 - Local Seek mode*;
Only strong stations will be tuned in.
The initial setting is DX.
 - D (Digital).DX Seek mode;
Automatically receives a receivable digital broadcast.
 - D (Digital).Local Seek mode;
Automatically receives a strong digital broadcast only.
 - Manual mode;
The frequency is manually tuned in steps
 - Program Type Seek mode (RBDS FM Radio mode only);
The currently selected program type station will be tuned.

- During Forced Analog mode, digital broadcasts cannot be received.
- * Depending on the signal, a digital or analog broadcast is received.

- 6 Touch ,  or ,  to change the radio frequency up or down respectively.**
In manual mode, touch and hold to change the frequency continuously.
 - The ,  buttons provide the same functions above.

Presetting Stations Manually

- 1 Tune in a desired radio station you wish to store in the preset memory by manual or automatic seek tuning.**
- 2 Touch the Preset number you want to store, for at least 2 seconds.**
The selected station is stored.
- 3 Repeat the procedure to store up to 11 other stations onto the same band.**
To use this procedure for other bands, simply select the desired band and repeat the procedure.
A total of 36 stations can be stored in the preset memory (12 stations for each band; FM1, FM2, or AM).
 - For details on switching to the Preset mode screen, see ⑦ in “HD Radio main screen example” (page 51).
 - If a preset memory has already been set in the same preset number, it will be cleared and the new station will be memorized.

Presetting Stations Automatically



The tuner can automatically seek and store 12 strong stations in the selected band.

Select the desired band then touch and hold (Auto Preset).

- The tuner automatically seeks and stores 12 strong stations into the preset buttons in ascending order of frequency. When automatic storing has completed, the station stored in the preset 1 is selected.
- If no stations are stored, the tuner will return to the original station you were listening to before the automatic storing procedure began.
 - You can cancel this process by touching  (Auto Preset) while the tuner is automatically seeking stations. Canceling will return the tuner preset to the previous setting.

Tuning to Preset Stations

You can tune in the preset stations in memory on either band using its preset number.

- 1 Touch .**
The radio band select pop up screen is displayed.
 -  button displays the current selected band. (e.g. [FM1])
- 2 Select the desired band from FM1/FM2/AM.**
- 3 Touch any one of the Preset numbers you have already stored in the Preset mode screen.**
The preset station is received.
 - For details on switching to the Preset mode screen, see ⑦ in “HD Radio main screen example” (page 51).

Inputting Frequency Directly and Receiving the Radio Station

You can input a frequency of the same band directly and receive the radio station.

1 Touch [] (Direct Tune).

The numeric keypad input mode screen appears.

2 Touch a desired number.

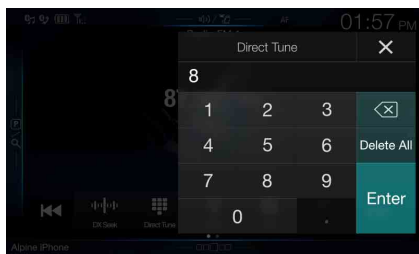

Touch [] to delete an entered number.

Touch [**Delete All**] to delete all entered numbers.

3 Touch [**Enter**] on the numeric keypad mode screen to confirm your selection.

Touch [] to hide the keypad display.

Receiving a Multicast (HD Radio™ Mode only)

Multicasting is the ability to broadcast multiple program streams over a single FM frequency. This increases the amount and diversity of content choices. A maximum of 8 multicast station channels can be selected on this unit.

- “Multicast” indicator appears when signal reception is possible.
- The station number of the current broadcast station appears behind the frequency (ex. 90.3 MHz-HD5 means there are 5 stations on 90.3 MHz).

Touch [], [] or [], [].

The sub channel of the received radio station is changed.

- If reception is lost during SPS broadcasting due to weak or no signal, the screen will display “HDx Signal loss.”

Selecting the Receivable Program Type (RBDS FM Radio mode only)

You can select and receive the currently receivable stations in the Program Type list screen.

■ Program Type list screen example





- For details on switching to the Program Type list screen, see ⑤ in “Preset mode screen example” (page 51).

Select the desired program type in the Program Type list screen.

Program Type Seek starts and the receivable program type is received.



If no Program Type station is found, “No program type available.” will be displayed.

- Touch [] or [] to select the same program type station as the currently selected program type after switching the tuning mode to Program Type (Program Type Seek) mode.

Forced Analog Mode

Activate the Compulsory Analog Radio mode to receive only analog radio signals.

Touch [] (Analog).

The [] (Analog) button is highlighted. To cancel Compulsory Analog Radio mode, touch [] (Analog) again.

- During Forced Analog mode, only analog broadcasts will be received even when digital broadcasts become available.

Displaying Radio Text (RBDS FM Radio mode only)

Text messages from a radio station can be displayed.

1 Tune in a radio station that transmits text messages.

2 Touch [] (Info) in the FM radio mode repeatedly to switch to the desired display.

Station Info.Mode → Radio Text Mode → Station Info.Mode

Station Info. Mode

Program Type /Frequency and PS Name/Artist Name/Song Name/Album Name

Radio Text Mode

Frequency/Radio Text

Using Ballgame Mode (HD Radio™ Mode only)

In live broadcast, such as sportscasts, etc., a time lag occurs between digital sound and analog sound. Therefore, when live broadcasts are received, a time lag between the real broadcast may occur and the unit can change to analog broadcasting automatically.

Touch [→📶] (Live) to switch On/Off.



The LIVE Indicator is displayed when Ballgame Mode is set to "On."

- When receiving a live broadcast while the Ballgame mode is on, the LIVE indicator is highlighted.

📶LIVE → 📶LIVE (During live broadcast)

About the Feature Logos

Digital Sound

- Digital, CD-quality sound. HD Radio Technology enables local radio stations to broadcast a clean digital signal. AM sounds like today's FM and FM sounds like a CD.

PSD

- Program Service Data: Contributes to the superior user experience of HD Radio Technology. Presents song name, artist, station IDs, HD2/HD3 Channel Guide, and other relevant data streams.

HD2/HD3

- Adjacent to traditional main stations are extra local FM channels. These HD2/HD3 Channels provide new, original music as well as deep cuts into traditional genre.

Artist Experience

- Visual information related to content being played on your HD Radio receiver, such as Album Art, historical photographs, still art from live broadcasts, among other related content.

USB Flash drive (Optional)

You can play back music files (MP3/WMA/AAC/FLAC) and video files (AVI/MKV/MP4) stored in a USB flash drive on the internal player of this system.

⚠ WARNING

It is dangerous for the driver to watch video while driving the vehicle. The driver may be distracted from looking ahead and an accident could occur.

Install the unit correctly so that the driver cannot watch a video unless the car is stopped and the parking brake is applied.

If the unit is not installed correctly, the driver will be able to watch a video while driving and may be distracted from looking ahead and cause an accident. The driver or other people could be severely injured.

■ USB Audio main screen example



Function mode



■ USB Video main screen example

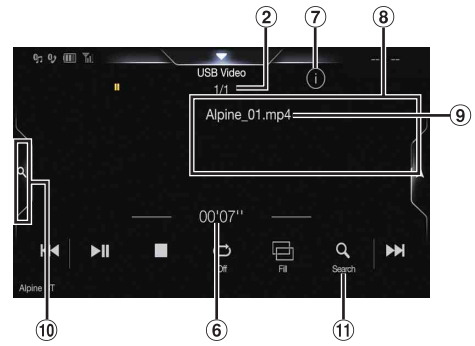

- ① Artwork display
 - You can change the artwork position. For details, see "Switching the Artwork Position" (page 39).
- ② Current track no./Total song no.
- ③ Artist title
- ④ Song title
- ⑤ Album title
- ⑥ Elapsed time
- ⑦ Info mode switching button
- ⑧ Info mode display
- ⑨ File Name
- ⑩ Quick Search button
Touch to use the Quick Search mode.
- ⑪ Full Search mode button
Touch when you use the Full Search mode screen.

■ Quick Search mode screen example

Swipe right vertically in the list to change pages.



- ⑫ Touch to close the Quick Search mode.

The USB Video operation screen display during video file playback

Touch the screen while the USB Video playback screen is displayed.

The USB Video operation screen is displayed.

- The operation screen changes to the visual screen in the USB Video mode for 5 seconds after an operation has been performed.
- For your safety, video is not displayed and only audio can be heard while driving.

Playback

- 1 Press the  (AUDIO) button to select USB mode.**
The display shows the USB mode screen.
 - You can select and change the source in the Menu screen (page 21) or Favorite screen (page 24).

- 2 Touch [] or [] to select the desired track (file).**

Returning to the beginning of the current (or previous) track (file):

Touch [].

Fast reverse :



Touch and hold [].

Advancing to the beginning of the next track (file) :

Touch [].



Fast forward :

Touch and hold [].

- The ,  buttons provide the same functions above.



- 3 To pause playback, touch [].**

Touching [] again will resume playback.

During playback, the [] indicator is displayed in Audio main screen. During a pause, the [] indicator is displayed in the Audio main screen.

- The playback time may not be correctly displayed when a VBR (Variable Bit Rate) recorded file is played back.
- If there is tag information, artist name/album name/track name is displayed.
- ID3 tag/WMA tag
If an MP3/WMA/AAC/FLAC file contains ID3 tag/WMA tag information, the ID3 tag/WMA tag information is displayed. (e.g., song name, artist name, and album name)

Fast-forwarding/Fast-reversing (USB Video only)

- 1 During playback, touch and hold [] (Fast-reverse) or touch and hold [] (Fast-forward).**
Touch and hold for more than 1 second to forward/reverse at 8x speed. Keep touching to switch the speed to 16x and 32x.

- 2 Release [] or [] to return to normal playback.**

- No sound is played back during fast-forwarding/fast-reversing.

Stopping Playback (USB Video only)

Touch [] during playback.

“STOP” indicator is displayed, and playback stops.

- Playback starts from the beginning when [] is touched while playback is stopped.

Repeat Play

- 1 Touch [].**

The Repeat mode select pop up screen is displayed.

- The [] button displays the currently selected mode.

- 2 Select your desired Repeat mode.**

Folder : Only files in a folder are repeatedly played back.

File : Only the file currently playing is repeatedly played back.

OFF : Repeat mode Off.

Random Play (USB Audio only)

- 1 Touch [].**

The Random Play mode select pop up screen is displayed.

- The [] button displays the currently selected mode.

- 2 Select your desired Random Play mode.**

ALL : All songs in the USB flash drive are played back in random sequence. Any one song does not play back again until all songs have been played back.

Folder : A Folder is selected randomly and songs in the Folder are played back in order. After all songs are played in a Folder, the next Folder is selected randomly.

File : All songs in the Folder (Folder/File) including the song currently being played are played back in random sequence.

OFF : Random mode Off.

- If you select a track by using the search mode, the Random Play mode will be canceled.

Searching for a Desired Song

You can search for your desired song by using one of two modes; the Quick Search mode and the Full Search mode.

Quick Search mode

Touch your desired Folder name or File name.

The selected Folder*¹ or File is played.

*¹ The first file in the selected folder is played back.

- For details on switching to the Quick Search mode, see ⑩ in “USB Audio main screen example” (page 55).

Full Search mode

1 Touch [Audio] or [Video] to switch whether the search list displays music files or video files.

2 Touch your desired Folder name*2 or File name.

When you select a File name, the selected song is played.

When you select a Folder name, repeat the same procedure to select another Folder name or File name.

*2 When you touch the [▶] by a Folder name, the unit plays from the first song in the Folder.

- For details on switching to the Full Search mode, see ⑪ in “Quick Search mode screen example” (page 55).
- To switch the displayed list or return to the previous page in the Full Search mode, see “About Basic Operation for List Screen” (page 18).

Switching Display Modes (During Video File Play Back)

You can switch the Display Mode while playing a Video File.

Touch [].

Each time you touch, the Display Mode is switched.

Fit → Fill → Fit

- The [] button displays the currently selected mode. (e.g. [Fit])
- You cannot operate them while driving.

Fit mode



The mode displays a picture while holding its aspect ratio.

- Black bands appear at the top/bottom or right/left side of the screen depending on the picture.

Fill mode



The mode displays a picture to fit its size vertically and horizontally with the monitor size.

About USB Video format

The video formats (USB Flash drive) supported by the unit are as follows.

- Supported Container: AVI, MKV, MP4
- Supported Video Coding: H.264/MPEG-4 AVC
- Supported Audio Coding: MP3, ACC, MPEG2 audio
- MAX File Size: 4GB

iPod/iPhone (Optional)

A separately sold Lightning to USB cable (KCU-471i), etc., is required. When the unit is connected by the above cable, the controls on the iPod are disabled.

- This unit does not support video playback from iPod/iPhone which connected to this unit via USB Connector.
- Internet or telephone functions, etc., of the iPhone or iPod touch are not controllable from the unit, but these functions can be controlled using the iPhone or iPod touch itself.

About iPod/iPhone models usable with this unit

- The following devices have been tested and shown to work with this unit. Correct function of earlier versions cannot be guaranteed.

iPhone XS: Ver.12.1
 iPhone XS Max: Ver.12.1
 iPhone XR: Ver.12.1
 iPhone X: Ver.12.1
 iPhone 8: Ver.12.1
 iPhone 8 Plus: Ver.12.1
 iPhone 7: Ver.12.1
 iPhone 7 Plus: Ver.12.1
 iPhone SE: Ver.12.1
 iPhone 6s Plus: Ver.12.1
 iPhone 6s: Ver.12.1
 iPhone 6 Plus: Ver.12.1
 iPhone 6: Ver.12.1
 iPhone 5s: Ver.12.1
 iPhone 5c: Ver.10.1.1
 iPhone 5: Ver.10.1.1
 iPhone 4s: Ver.9.3.5
 iPod touch (6th generation): Ver.12.1
 iPod touch (5th generation): Ver.9.3.5
 iPod nano (7th generation): Ver.1.0.4

■ iPod/iPhone main screen example

Audio mode



Function mode



- ① Artwork display
 - You can change the artwork position. For details, see "Switching the Artwork Position" (page 39).
- ② Current song no./Total song no.
- ③ Artist title/Release Date*1
- ④ Song title/Episode title*1
- ⑤ Album title/Podcast title*1
- ⑥ Total time for playing
- ⑦ Full Search button
Touch when using Full Search mode.
- ⑧ Elapsed time
- ⑨ Quick Search button*2
Touch when using Quick Search mode.

*1 Podcast mode.

*2 If you have never used Search mode with the currently connected iPod/iPhone, pressing the Quick Search button switches the screen to the Full Search mode screen.

■ Quick Search mode screen example

Swipe vertically in the list to change pages.





- ⑩ Touch to close the Quick Search mode

Playback

- 1 **Press the  (AUDIO) button to select iPod mode.**
The display shows the iPod mode screen.
 - You can select and change the source in the Menu screen (page 21) or Favorite screen (page 24).



- 2 **Touch [] or [] to select the desired track (file).**

Returning to the beginning of the current (or previous) track (file):
Touch [].



Fast reverse the current track :
Touch and hold [].

Advancing to the beginning of the next track (file) :
Touch [].

Fast forward the current track :
Touch and hold [].

- The ,  buttons provide the same functions above.

- 3 **To pause playback, touch [].**

- If a song is playing on the iPod/iPhone before it is connected to the unit, it will continue playing when it is connected.
- An episode may have several chapters. The chapter can be changed by touching [] or [].
- If the artist, album or song name, created in iTunes, has too many characters, songs may not be played back when connected to the unit. Therefore, a maximum of 64 characters is recommended. The maximum number of characters for the unit is 64.
- Some characters may not be correctly displayed.

Searching for a Music File

An iPod/iPhone can contain thousands of songs. For this reason, this unit can make various searches using the search function as shown below.

Using the Playlist/Artist/Album/Podcast/Audiobook/Genre/Composer/Song/iTunes Radio search mode's individual hierarchy, you can narrow down your search as shown in the table below.

<MUSIC Search Menu>

| Hierarchy 1 | Hierarchy 2 | Hierarchy 3 | Hierarchy 4 |
|--------------|-------------|-------------|-------------|
| Playlists | Songs | — | — |
| Artists | Albums | Songs | — |
| Albums | Songs | — | — |
| Songs | — | — | — |
| Podcasts | Episodes | — | — |
| Genres | Artists | Albums | Songs |
| Composers | Albums | Songs | — |
| Audiobooks | — | — | — |
| iTunes Radio | — | — | — |

Quick Search Mode

In Quick Search mode, the list from the previous search mode is displayed. For example, if the last time you searched for songs was in Albums, the Album list is displayed. If you have not used the search mode, the list is not displayed in the Quick Search mode. In this case, go to the Full Search mode.

In Quick Search mode, touch the desired list (for example, Album list).

The selected Album is played.

- To switch into Quick Search mode, see ⑨ in "iPod/iPhone main screen example" (page 58).
- To search within an Album, go to the Full Search mode.
- Depending on the connected iPod/iPhone, this function may not available.

Full Search Mode

For example: Searching by Artist name

The following example explains how an Artists search is performed. Another search mode can be used for the same operation, although the hierarchy differs.

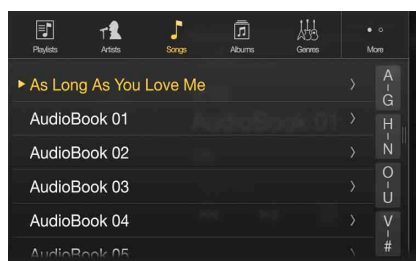

- 1 **Touch [Artists] in the Full Search mode screen.**

The Artists search screen is displayed.

- To switch into Full Search mode, see ⑦ in "Quick Search mode screen example" (page 58).

- 2 **Select the desired artist.**

To play back the Artist directly

- 1 Touch [] of the artist's name.
All songs of the selected artist are played back.

To search for the Album of the Artist

- 1 Touch the selected artist name.
The Albums search screen of the selected artist is displayed.
- 2 Touch [] of the desired album's name.
All songs of the selected album are played back.

To search for a Song in the Album of the Artist

- 1 Touch the desired artist's name.
All albums of the selected artist are displayed.

- 3 **Touch the desired album's name.**

All songs of the selected album are displayed.

- 4 **Touch the desired song's name.**

The selected song is played back.

- An alphabet skip function is available. See "Alphabet Search Function" (page 60).
- To switch the displayed list or return to the previous page in the Full Search mode, see "About Basic Operation for List Screen" (page 18).

Alphabet Search Function

The unit is provided with an alphabet search function for effective searching. When you use this function in the search mode, you can quickly search an artist or a song, etc.

This is an example of how to search Artist Name for names beginning with “R”.

1 Touch “O-U” of the alphabet group.



“O P Q R S T U” of the alphabet group “O - U” is displayed.

2 Touch “R” you want to search.

Artist names beginning with “R” are displayed.

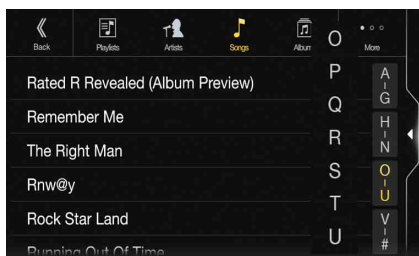

3 Touch your desired artist name.

- If there are no names in the list beginning with that letter, the next letter of the alphabet is searched.

For example: If there are no names beginning with “R,” the search list begins with “S.”

Repeat Play

1 Touch [].

The Repeat mode select pop up screen is displayed.

- [] displays the currently selected mode.

Repeat All / Track Repeat / OFF

Random Play (Shuffle)

1 Touch [].

The Random Play mode select pop up screen is displayed.

- The [] button displays the currently selected mode.

2 Select your desired Random Play mode.

The selected Random Play mode changes the button.

- Album : The songs on each album are played back in proper order. Upon completing of all the songs on the album, the next album is selected randomly. This continues until all albums have been played.
- Songs : Song shuffle randomly plays back songs within a selected category (playlist, album, etc.). The songs within the category are played just once until all songs have been played.
- OFF : Random mode Off.

- The action depends on the connected iPod.

Pandora® Music (optional)

Pandora® Music is your own FREE personalized radio now available to stream music on your Smartphone (which runs Android OS or iOS). Just start with the name of one of your favorite artists, songs or classical composers and Pandora® will create a “station” that plays their music and more music like it.

The unit enables you to interact with your Pandora® account by connecting an iPhone or Android smartphone that has the latest version of the Pandora® application installed.

- You can also enjoy Pandora® from Apple CarPlay screen.
- If no sound is output when you connect an iPhone with a “Set Bluetooth Device” setting of both “Hands-free” and “Bluetooth Audio” to the unit’s USB port and change the Audio source from Bluetooth Audio, set “Alpine TuneIt App” to “USB (iPhone)” or “Off.” For more details, see “Pairing a Bluetooth Device” (page 29) and “Smartphone Apps Setup” (page 49).

■ iPhone Pandora main screen example



Function mode



■ Bluetooth Pandora main screen example



Function mode

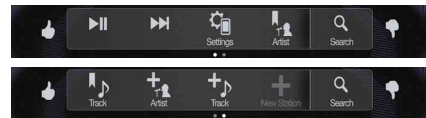

- ① Station name
- ② Artist Name
- ③ Song Name
- ④ Album Name
- ⑤ Playing time
- ⑥ Artwork display

Listening to Pandora®

1 Launch the Pandora® on the smartphone.

2 Press the **🎵 (AUDIO)** button to select Pandora® or Bluetooth Pandora® mode.

The display shows the Pandora mode screen.

- You can select and change the source in the Menu screen (page 21) or Favorites screen (page 24).

3 To pause playback, touch **[▶ ||]**.

4 To skip to the next song, touch **[▶▶]**.

- The operation to replay a previous song is not available.
- Pandora® limits the number of skips allowed on their service. If you attempt to skip songs beyond the limit, “Our content licenses limit the number of tracks you may skip.” is displayed.
- Even if you reconnect an iPhone without launching Pandora Application while the power is off, Pandora mode (not iPod mode) is displayed when power is turned back on.
- Depending on the signal status, song may be stopped during playback.
- While receiving an advertisement, you cannot operate any buttons other than **[▶ ||]** (play/pause) and **[Q]** (Search).
- The playback time may not be correctly displayed.
- The display content varies when ads are received.

“Thumbs” Feedback

You can personalize your stations with “Thumbs Up” or “Thumbs Down” feedback, which the system takes into account for future music selections.

During playback, touch [👍] for thumbs up, or touch [👎] for thumbs down.

- 👍: The “👍” indicator appears in the display. Pandora® will add similar music to your station.
- 👎: The “👎” indicator is displayed. Pandora® will ban that song from your station, and the current song is skipped. If the number of skips allowed has reached its limit, the current song continues to play back.

- In some situations, “Thumbs” feedback may not be available.

Searching for a Desired Station

You can display your station list and select stations directly from the unit.

1 Touch [🔍] (Search) to activate the Search mode.

Alphabet Search

2 Touch [By A-Z].

The “By A-Z” search mode is activated and the station names are listed alphabetically.

3 Touch the desired station.

Pandora will play that station.

Search by Date Added

2 Touch [By Date].

The “By Date” search mode is activated and the station names are listed by the date they were added to the account.

3 Touch the desired station.

Pandora will play that station.

Shuffle

Use Shuffle to create a playlist based on two or more of your Pandora stations. Edit your Shuffle station selections on the Pandora Compatible Application for iPhone when it is not connected to the unit.

1 Touch [🔍] (Search) to activate the Search mode.

The “By A-Z” or “By Date” search mode is activated and the station name is displayed.

2 Touch [🔀] (Shuffle).

- The 🔀 indicator lights, and the songs from the created stations are played back in random sequence.

Creating a New Station

Based on the currently playing song or artist, a personalized Pandora station can be created. The new station will play more music like it.

Free word

1 During playback, touch [➕] (New Station).

The Key Pad screen is displayed. You can enter a keyword and search for Artist/Song.

2 Enter a keyword and touch [OK].

3 Touch the desired list.

The new station is automatically applied.

- For details of how to input characters from the keypad, refer to “How to Input Characters and Numbers (Keypad)” (page 23).
- You cannot operate them while driving.

Artist/Track

During playback, touch [👤] (Artist) or [🎵] (Track).

- The created station is saved to your station list.
- When the Smartphone is not connected to this unit, you can create personalized Pandora® stations using the Pandora® Application on your Smartphone. You can also create stations on the web at www.pandora.com.
- In some situations, creating a new station may not be available.

Bookmarking a Desired Track or Artist

The currently playing song or artist can be bookmarked and saved to your Pandora account.

During playback, touch [👤] (Artist) or [🎵] (Track).

The current track or artist is bookmarked. “🎵” icon or “👤” icon is displayed.



- Your bookmarks can be viewed on your “Profile” page at www.pandora.com.
- In some situations, bookmarks may not be available.

Connecting a Bluetooth Device (Bluetooth Pandora® Only)

Registering a Bluetooth device in the unit enables automatic connection. If it does not connect automatically, run through the connection procedure again.

- 1 Touch [📶] (Phone Setting).**
The Device Setting select pop up screen is displayed.
- 2 Touch [Reconnect].**
Bluetooth connection will start.

Disconnecting the Bluetooth Connection

- 1 Touch [📶] (Phone Setting).**
The Device Setting select pop up screen is displayed.
- 2 Touch [Disconnect].**
The Bluetooth connection is disconnected.

Changing the connecting Bluetooth Device

If multiple Bluetooth devices are registered in this device, you can change the connection among the registered devices.

- 1 Touch [📶] (Phone Setting).**
- 2 Touch [Change Phone].**
- 3 Touch [🎵] (Audio) or [📞] (Hands-free) of the selected device.**
The connection will transfer to the selected device.

SiriusXM Satellite Radio Operation (Optional)

SiriusXM Tuner operation:

When an optional SiriusXM Tuner is connected to this unit, the following operations may be performed.

■ SiriusXM main screen example (Song Info. Mode)



Function mode

The Function mode switch is different depending on TuneStart mode and Replay mode.

< When TuneStart mode is not active >



< When TuneStart mode is active >



< During Replay mode >



- ① Signal Indicator
Indicates the signal strength of SiriusXM.
- ② Info area
Channel Info. Mode*:
Channel No/Long Channel Name/Category Name
Song Info.Mode:
Artist Name/Song Name/Content Info
- ③ Search mode button
Touch when you use the Search mode screen.
- ④ Album Art
The image that corresponds with the channel currently being received is displayed.
 - You can change the artwork position. For details, see "Switching the Artwork Position" (page 39).
- ⑤ Preset mode button
Touch when you use the Preset mode screen.

* In Channel Info. Mode, the Channel logo currently being received is displayed on the left side of the Long Channel Name.

■ Preset mode screen example

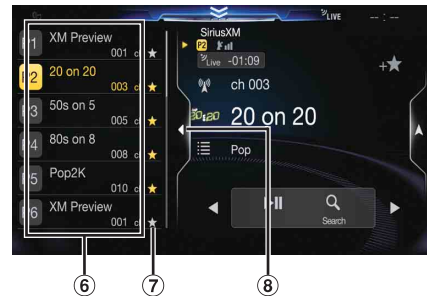

- ⑥ Preset buttons
Swipe vertically in the list to change pages.
- ⑦ SmartFavorites (★) button
"★" is a symbol of SmartFavorites channel. When a preset channel is stored, it will be designated as a SmartFavorites channel and the ★ button lights up. Touch this button to cancel the SmartFavorites channel and ☆ is displayed.
- ⑧ Touch to close Preset mode screen

Receiving Channels with the SiriusXM Tuner

About SiriusXM Satellite Radio

Only SiriusXM® brings you more of what you love to listen to, all in one place. Get over 140 channels, including commercial-free music plus the best sports, news, talk, comedy and entertainment. Welcome to the world of satellite radio. A SiriusXM Vehicle Tuner and Subscription are required. For more information, visit www.siriusxm.com.

After you have found the SiriusXM Radio ID, you can activate your radio. See section “Checking the SiriusXM Radio ID Number”



In the USA, you can activate online or by calling SiriusXM Listener Care:

- Visit www.siriusxm.com/activatenow
- Call SiriusXM Listener Care at 1-866-635-2349

For Canadian Subscriptions, please contact:

- Visit www.siriusxm.ca/activatexm
- Call XM Customer Care at 1-877-438-9677
- The SiriusXM Satellite Radio controls on this unit are available only when a SiriusXM Tuner is connected.

- 1 Press the  (AUDIO) button to select SiriusXM mode.**
The display shows the SiriusXM mode screen.
 - You can select and change the source in the Menu screen (page 21) or Favorites screen (page 24).

- 2 Touch [] or [] to select the desired channel. Touching and holding either button will rapidly browse through the channels.**

- Refer to the SiriusXM Tuner User Guide for details on how to install the SiriusXM Tuner.

Tuning Channels by Category

Channels are grouped into categories based on the type of content heard on the channels.

- 1 Touch [] (Category) on the SiriusXM main screen to activate the category browsing mode.**
The channels within the category of the current channel are listed.

Category browsing mode screen example

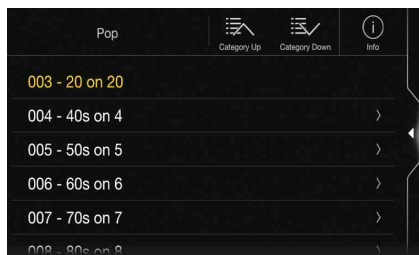

- Touching [] (Info) changes the display of information for the channels in the category with the following three options.
Channel No./Channel Name → Channel No./Artist Name →
Channel No./Song Title → Channel No./Content Info →
Channel No./ Channel Name

- 2 Touch [] (Category Up) or [] (Category Down) on the category browsing mode screen to select a desired category.**

The Category Name is shown at the top of the display.

- 3 Select the desired channel.**

Changing the Display

Text information, such as the channel name, artist name/feature, and song/program title, is available with SiriusXM. The unit can display this text information as explained below.

Touch [] (Info).

Each time you touch this button, the Channel Info. mode and the Song Info. mode switch alternately. For displayed contents, see “SiriusXM main screen example (Song Info. Mode)” (page 64).

Checking the SiriusXM Radio ID Number

To subscribe to the SiriusXM Satellite Radio service, it is necessary to locate and identify the Radio ID of your SiriusXM Tuner. You can check the Radio ID on the bottom surface of the SiriusXM Tuner box. You can also check it from this unit by performing the following procedure.

- 1 While receiving SiriusXM Radio, touch [] or [] to select channel “0”.**

The unit displays the Radio ID number.

- 2 To cancel the Radio ID number display, change the channel to a channel other than “0”.**

- The SiriusXM Radio ID does not contain the letters I, O, S, or F.

Storing Channel Presets

You can store 18 of your favorite SiriusXM channels for easy recall with Preset buttons.

- 1 Press the Preset number you want to store, for at least 2 seconds to store the channel.**
The selected channel is designated as a SmartFavorites channel.

- 2 Repeat the procedure to store up to 17 other channels.**
A total of 18 channels can be stored in the preset memory.

- For details about SmartFavorites channels, see “SmartFavorites Functions” (page 66).
- To switch to the Preset mode screen, see  in “SiriusXM main screen example (Song Info. Mode)” (page 64).
- If you store a new channel into a preset which already has a channel assigned, the current channel will be cleared and replaced with the new one.

Tuning Channels using Presets

Touch any one of the Preset numbers you have already stored in the Preset mode screen.

The preset channel is received.

- To switch to the Preset mode screen, see  in “SiriusXM main screen example (Song Info. Mode)” (page 64).

SmartFavorites Functions

SmartFavorites allow you to rewind and replay any missed programming from your current Band of Preset channels. Miss a music, news, talk or sports segment? No Problem, because you can rewind and replay when you tune to one of your SmartFavorites channels and hear what you missed. Note that buffering starts 5 seconds after changing the band. It takes 5 seconds for SmartFavorites to start buffering the preset channels in the new band. TuneScan and TuneStart functions are enabled by the above-mentioned SmartFavorites functionality.

TuneStart™ Function

With the TuneStart™ feature turned ON, you will hear the beginning of the song when you tune to one of your SmartFavorites channels. It may take a minute or two for the feature to work after power up or after changing preset bands.

1 Touch and hold [⏮] (TuneStart) for at least 2 seconds to activate or deactivate the TuneStart function.

When the TuneStart function is activated, [⏮] (TuneStart) is highlighted.

2 On the Preset Mode screen, touch the Preset number. TuneStart mode will begin.

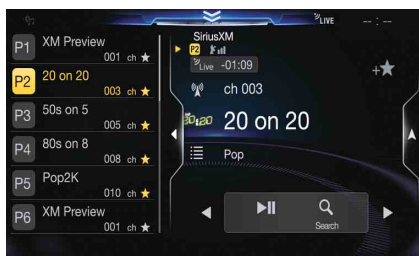

During TuneStart mode, the time difference between the play point and Live radio is displayed by the "P Live -01:24" indicator.

- To switch to the Preset mode screen, see ⑤ in "SiriusXM main screen example (Song Info. Mode)" (page 64).
- The number of preset channels that TuneStart can access differs depending on the SiriusXM Tuner Box.
- Touching [▶▶] (Track Up) or [◀◀] (Track Down) will move a track up/down.
- To fast reverse, touch and hold [◀◀] (Track Down) and to fast forward, touch and hold [▶▶] (Track Up).
- When you touch [→🎵] (Live) or [⏮] (TuneStart) during TuneStart, the program currently selected in TuneStart mode changes to the program currently being broadcast.
- This function is available only when SiriusXM Tuner-SXV200 or later is connected. When Tuner-SXV200 is connected, this function is available only for Preset channels 1-6. When Tuner-SXV300 is connected, this function is available for all Preset channels.
- Preset channels that play other than music-type content will start playing the channel from the current live play point when selected.

TuneScan™ Function

If you've got more than one Favorites music channel, you've got a lot of choices every time you tune in. Instead of pushing every preset button and hearing the live song, you can simply use the TuneScan function to get a short preview of songs that you have missed on each of your SmartFavorites music channels.

1 Touch [⏮] (TuneScan).

The [⏮] (TuneScan) icon is highlighted during TuneScan mode.

2 Touch [⏮] (TuneScan) during scan playback, TuneScan mode will be canceled and the selected track will be played back normally.

Touch and hold [⏮] (TuneScan) for at least 2 seconds during scan playback to cancel TuneScan mode. The tuner returns to the channel before TuneScan was initiated.

- This function is available only when SiriusXM Tuner-SXV200 or later is connected. When Tuner-SXV200 is connected, this function is available only for Preset channels 1-6. When Tuner-SXV300 is connected, this function is available for all Preset channels.
- If no operation is performed during the scanning process, when scanning finishes, the next mode depends on the SiriusXM Tuner.
- During TuneScan mode, the artist and song name will be displayed.
- The SiriusXM Tuner scans through the songs from the preset music channels on the current band only, scanning from oldest to newest.
- The number of Preset channels and the play times that can perform TuneScan differ depending on the SiriusXM Tuner box.

Search Function

1 Touch the ③ Search mode button.

The Search list screen appears.

Search item:

All Channels / Category Name*1 / My Music / My Games / Featured*2

*1 The Category name for the channel currently being received is displayed.

*2 Displayed only when the SiriusXM Tuner-SXV200 or later is connected.

- You can switch the category by touching [≡] (Category Up) or [≡/✓] (Category Down) on the List screen after selecting a Search item other than Featured.
- You can switch the display format by touching [i] (Info) in the List screen after selecting a Search item.
Channel No./Channel Name → Channel No./Artist Name → Channel No./Song Title → Channel No./Content Info → Channel No./Channel Name

Searching by Channel

2 Touch [All Channels].

All Channels will be displayed in a list.

3 Touch the selected channel.

The channel you selected is received.

Searching by Category

2 Touch Category Name.

The channels within the category of the current channel are listed.

3 Touch the selected channel.

The channel you selected is received.

Searching by My Music

2 Touch [My Music]*.

The artist names and song titles that you have stored and are currently playing will be displayed in a list.

* Displayed only when the stored song or artist is broadcasting.

3 Touch the desired artist/song.

The channel of the selected artist/song being broadcast is received.

Searching by My Games

2 Touch [My Games]*.

When the sports teams that you have stored are currently playing a game that is being broadcast, they will be displayed in a list.

* Displayed only when the game of stored team is broadcasting.

3 Touch the desired team.

The channel of the selected game being broadcast is received.

Searching by Featured Favorites

1 Touch [Featured]*.

The Category that SiriusXM recommends will be displayed in a list.

* Displayed only when the SiriusXM Tuner-SXV200 or later is connected.

2 Touch the desired category.

3 Touch the desired channel within the selected category.

The channel you selected is received.

Selecting the Channel Directly

You can directly select the channel number by using the numeric keypad.

1 Touch [⌨] (Direct Tune).

The numeric keypad input screen is displayed.

2 Touch to input the channel number.

3 Touch [Enter].

The selected channel is received.

Storing the desired Song/Artist

While listening to SiriusXM Satellite Radio, you can be alerted when your favorite songs or artists are playing on other channels. The radio will display an Alert message when a matching artist or song is found on another channel. Then you can choose if you want to tune to that favorite or you can ignore the alert and stay on your current channel. Information on setting up the Artist and Song Alerts is described in "Receiving and Tuning to an Alert".

1 Touch [⏸] (Set Alert) on the SiriusXM mode screen.

The Memory type selection screen is displayed.

2 Touch the "Artist Saved" or "Song Saved" to choose to store the Artist or the Song.

Total registrations and Remaining number of registration slots is displayed for 2 seconds, then the Artist or Song is registered as an Artist alert or Song alert.

- The maximum number of registered Teams, Artists, and Songs is 50. For details on how to register a Favorite Team, see "Setting the Favorite Sports Team Alerts" (page 42).
- "Artist /Song Unavailable" appears on the display if both the artist and song is not available to be stored.
- "Artist (Song) Unavailable" is displayed if just the artist (song) is not available to be stored.
"Artist (Song) Saved" is displayed if this Artist (Song) was previously stored.
- If there is no memory space, "Alert Memory Full" is displayed, and then you are asked whether you want to replace a stored item. If you select "OK" then the list of stored alert items is displayed. Touch the item that you want to replace.

Receiving and Tuning to an Alert

Whenever a stored sports team, artist, or song is playing on another channel, an interruption Alert appears on the unit display. To tune to the game, artist or song identified by the alert, follow the steps below:

1 When stored information is broadcast, after displaying "Song Alert," "Artist Alert" or "Game Alert," a Pop up screen is displayed.

2 Touch [Tune] to receive.

Touch [Dismiss] to skip.

- Touch [ⓘ] (Info) on the My Music list/My Games list screen, the information of the broadcasting channels will be changed. Each time you touch the [ⓘ] (Info), the display changes as below.
My Music list:
Artist name → Song Title → Content Info → Channel name → Artist name
My Games list:
League Short Name → Team Abbrev/Team Nickname → Content Info → Channel name → League Short Name

Replay Function

In SiriusXM mode, you can pause, rewind and replay live Satellite Radio.

■ Replay mode screen example



- ① Buffer usage
- ② Current Replay point
- ③ Replay status indicator (|| or ▶)
- ④ Replay range
- ⑤ Time to live

1 Touch [▶ ||] to Pause playing of the channel content.
The "|| (Pause)" indicator and replay progress bar is displayed.

2 Touch [▶ ||] again to resume playing the content.
The "▶ (Play)" indicator lights up and offset playback commences.

3 Touch [→ 📶] (Live) to exit Instant Replay and listen to live content.

- To fast reverse, touch and hold [⏮] and to fast forward, touch and hold [⏭].
- Touching [⏮] or [⏭] will move a track up/down.
- If you change channels while in Replay mode, the contents of the replay buffer are emptied.
- The allowed recording time differs depending on the SiriusXM Tuner box.

Parental Lock Function

The Parental Control feature allows you to limit access to any SiriusXM channels, including those with mature content. When enabled, the Parental Control feature requires you to enter a passcode to tune to the locked channels. For information on setting the Parental Control passcode, see "Setting the Parental Lock" (page 43).

When a locked channel is selected, "Channel <xxx> Locked" is displayed and then the numeric keypad appears for you to enter the passcode.

Input the 4-digit passcode you set in "Setting the Parental Lock" (page 43).

The initial number is 0000.

- If you input a wrong passcode, "Incorrect Pass Code entered" is displayed.
- After entering the correct passcode, you can access all locked channels without entering the passcode again until the unit is powered off and then back on.

Using Jump Memory and Jump Recall function

The Jump Channel is a special channel that you can jump to with the press of a dedicated button and then jump back to the previous channel. This channel is often used to select your favorite SiriusXM traffic and weather report channel.

- 1 To store the Jump channel in memory, touch and hold [→] (Jump) for at least 2 seconds.**
- 2 Touch [→] (Jump) to recall and tune to the saved Jump channel.**
- 3 Touch [→] (Jump) again to receive the previous channel.**

- While receiving the Jump channel, you cannot perform other operations.
- Only one channel can be stored as the jump source channel. When you want to store a new channel, the old channel will be cleared and the new one will be stored.

HDMI Device

Devices supporting HDMI can connect and play back through this unit (for example, an optional DVE-5300 (DVD Player), iPhone or other Smartphones). When making HDMI connections, you need to set HDMI on the unit suitable for the connected device. For details, see “HDMI Setup” (page 44).

- The HDMI/MHL connecting cable differs depending on the connected device corresponding to HDMI. Prepare optional HDMI/MHL connecting cable sets suitable for your device.

When you connect an optional DVE-5300 (DVD Player), you can operate it from the unit. For details on how to operate the DVD player, see “DVD Player Operation”.

For details on how to operate iPhones and Smartphones, see “HDMI Operation” (page 75).

About HDMI selector (Optional)

HDMI selector is used when you add HDMI devices (iPhone or other Smartphones).

- Set “Setting the HDMI Selector On/Off” (page 48) to “On” when using the HDMI selector.
- For details on how to switch the HDMI source by using the HDMI selector, see “Switching the source when two HDMI devices are connected” (page 76).

DVD Player Operation

You can operate discs using the Remote Control unit supplied with the DVE-5300 (DVD Player). For details on operating the Remote Control unit, refer to the Owner’s Manual of the DVE-5300.

- For details on the types of playable discs and formats, refer to the Owner’s Manual of the DVE-5300.

DVD Player SETUP

You cannot perform DVD Player Setup while driving.

Your vehicle must be parked with the ignition key in the ACC or ON position. For details, see “To display the Setup Menu screen” in “Setup Operation” (page 28).

You can setup only when a disc is not inserted or playback stops.

- For details on the setting items, refer to the Owner’s Manual of the DVE-5300.

1 Touch [⚙️] (Setup).

The Setup main screen is displayed.

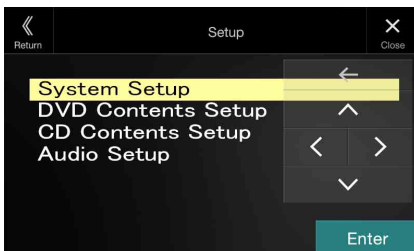

Setting items:

System Setup / DVD Contents Setup / CD Contents Setup / Audio Setup

2 Touch [^] or [v] to select the setting item.

3 Touch [Enter], then touch [<], [>], [^] or [v] to change the setting item.

4 Touch [X] to return to the main source screen.

- Touch [⏪] (Return) to return to the previous display.
- For details on the [⚙️] (Setup) button, see Function mode in “CD/MP3/WMA/AAC/WAV” (page 69) or “DVD” (page 71).

CD/MP3/WMA/AAC/WAV

■ MP3/WMA/AAC main screen example

Info mode

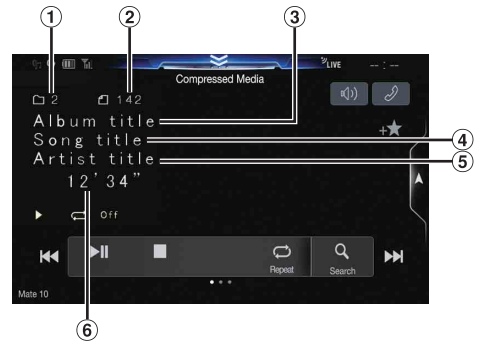

Function mode (MP3/WMA/AAC)



- ① Current song no.
- ② Total song no.
- ③ Album title
- ④ Song title
- ⑤ Artist title
- ⑥ Elapsed time

Function mode (CD)



- If there is no CD text, the message “No Text” appears.

Playback

- 1 Press the (AUDIO) button to select DVD (CD) mode. The display shows the DVD (CD) mode screen.
 - You can also select and change from the Menu screen (page 21) or Favorite screen (page 24).

When a disc is inserted into the disc slot of the DVD Player, with the label side facing up, the unit starts playback of the disc.

- 2 Touch [] or [] to select the desired track (file).

Returning to the beginning of the current (or previous) track (file):

Touch [].

Fast reverse :

Touch and hold [].

Advancing to the beginning of the next track (file) :

Touch [].

Fast forward :

Touch and hold [].

- The , buttons provide the same functions above.

- 3 To pause playback, touch [].

- Any file protected by DRM (Digital Rights Management) copy protection, cannot be played back on this unit.
- If a disc contains both audio data and MP3/WMA/AAC/WAV data, this unit plays back only the audio data.
- The track display for CD audio data playback shows the track numbers recorded on the disc.
- If an MP3/WMA/AAC/WAV disc with many files and folders is played, it may take longer than normal to start playback.
- The playback time may not be correctly displayed when a VBR (Variable Bit Rate) recorded file is played back.

Stopping Playback

Touch [] during playback.

“STOP” indicator is displayed, and playback stops.

- Playback starts from the beginning when [] is touched while playback is stopped.

Repeat Play

Touch [] to repeatedly play back.

The tracks (files) will be played repeatedly.

The repeat mode switches every time the button is touched.

CD:

Track Repeat → Off → Track Repeat

MP3/WMA/AAC:

Repeat File → Repeat Folder* → Off → Repeat File

- * Only files in a folder are repeatedly played back.

- If the Repeat Play mode is activated during MIX playback, the MIX mode will be canceled.

MIX (Random Play)

Touch [] during playback.

The tracks (files) on the disc will be played back in a random sequence.

The MIX mode switches every time [] is touched.

CD:

MIX → Off → MIX

MP3/WMA/AAC:

MIX Folder*1 → MIX (Disc)*2 → Off → MIX Folder*1

*1 Only files in a folder are played back in random sequence.

*2 All files on the disc will be played back in a random sequence.

- If the MIX mode is activated during Repeat playback, the Repeat Play mode will be canceled.
- If you select a track by using the search mode, the MIX play mode will be canceled.

File/Folder Name Search (Concerning MP3/WMA/AAC/WAV)

- 1 Touch [] (Search) during playback.

The search mode is activated.

The mode is changed to the search mode, and the list select panel appears.

- 2 Touch [] or [] in the list select panel to select Folder or File, then touch [Enter].

When selecting Folder, select File following same procedure, then touch [Enter].

- When there are 9 or more names on the list, a page number is displayed. Touch [] or [] to change the page.
- Touch [] or [] to change the list select panel location from right to left or vice-versa.
- To return to the previous hierarchy, touch [].

Selecting Folders (Concerning MP3/WMA/AAC/WAV)

Touch [] (Folder Down) or [] (Folder Up) to select the folder.

Info Mode Function

You can display the DISC information.

- 1 During playback, touch [] (Display).

The playback status is displayed.

- 2 The playback status display closes when [] (Display) is touched.

- For details on the display example, see Info mode in “MP3/WMA/AAC main screen example” (page 69).

DVD

DVD Video main screen example



Function mode

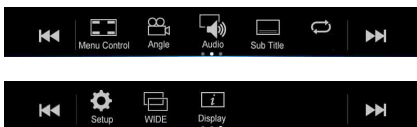

Info mode



- ① Title no./Chapter no.
- ② Audio signal output/Subtitle/Angle
- ③ Elapsed time

Video CD main screen example

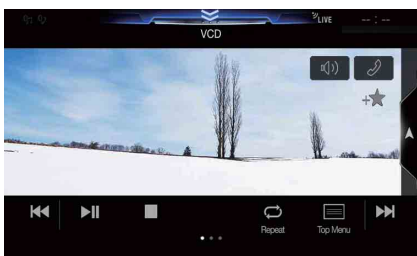

Function mode

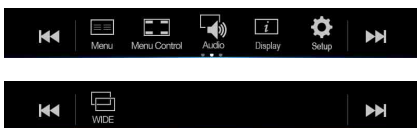

Info mode



- ① Current track no.
- ② Playback control (PBC)/Current audio status
- ③ Elapsed time

Disc types that can be used for each heading are represented by the following marks.



DVD Commercial Video discs (used for the distribution of movies, etc.) or a DVD-R/DVD-RW, DVD+R/DVD+RW recorded in a video mode can be used.



Video-CD discs can be used.

The DVD operation screen display

Touch the screen while the DVD playback screen is displayed. To display the operation screen, touch [Control].



- The operation screen changes to the visual screen in the DVD mode for 5 seconds after an operation has been performed.
- If you try to activate the DVD while driving, the display will show the warning-Picture off for your safety.
- Some operations cannot be carried out depending on the disc or playback screen.

Playing a Disc DVD-V V CD

WARNING

It is dangerous for the driver to watch the DVD while driving the vehicle. The driver may be distracted from looking ahead and an accident could occur.

Install the unit correctly so that the driver cannot watch DVD unless the vehicle is stopped and the emergency brake is applied.

If the unit is not installed correctly, the driver will be able to watch DVDs while driving the vehicle and may be distracted and could cause an accident. The driver or other people could be severely injured.

CAUTION

- Not all functions will operate for every DVD. See the individual DVD's instructions for details on the features supported.
- Fingerprints on a disc may adversely affect playback. If a problem occurs, remove the disc and check for fingerprints on the playback side. Clean the disc if necessary.
- If you switch the power or Ignition key OFF or change sources during playback, playback will continue where you left off when you resume playback.
- If you try to perform an invalid operation (based on the type of disc being played), the following mark is displayed on the monitor screen: 

- **Play Position Memory Function**
Even if you turn power off or switch the Ignition key to OFF during playback or change the source, playback will continue from the point where playback stopped when the power is turned ON again.

1 Press the (AUDIO) button to select DVD (CD) mode.

The display shows the DVD (CD) mode screen.

When a disc is inserted into the disc slot of the DVD Player, with the label side facing up, the unit starts playback of the disc.

- The reverse side of a double-sided DVD will not be played automatically.
Remove the disc, turn it over, and reinsert it.
- DO NOT insert discs containing maps for the navigation system. Doing so could result in damage.
- For your safety, video is not displayed and only audio can be heard while driving.

If a Menu Screen Appears

On DVD mode, menu screens may appear automatically. If this happens, perform the operation described below to start playback.

Direct Menu Operations DVD-V

1 Touch the screen while the DVD menu is being displayed.

Directly touch operation switches displayed on the screen to operate.

- To display the operation screen, touch [Control].

2 Touch the DVD menu directly.

- Some operations cannot be performed depending on the disc.

Menu Operations DVD-V V CD

1 Touch [] (Menu Control).

The menu operation mode will be displayed.

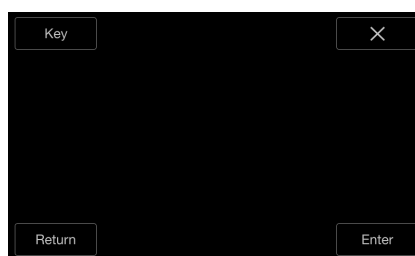

- You cannot operate them while driving.



2 Touch [Key].

The Key panel is displayed.

Touch [Return] to return to the previous display.

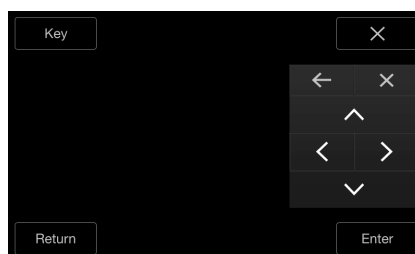
3 Select a desired menu item by touching [, [, [, or [].



- Touch [] or [] to change the Key panel location from right to left or vice-versa.
- Touching [] in the operation panel returns to the screen in step 1.
- Touching [Key] displays the numeric keypad input mode screen. For details of the numeric keypad input mode screen, see "Numeric Keypad Input Operations" (page 73).

4 Touch [Enter] to confirm the selected item.

Numeric Keypad Input Operations (DVD-V)

- 1 Touch **[Key]** again in the menu operation mode.
The numeric keypad input mode screen appears.
- 2 Touch a desired number.

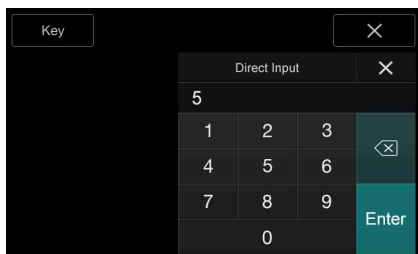

Touch [**X**] to delete an entered number.
To delete all the numbers you have entered, touch [**X**] for at least 2 seconds.

- 3 Touch **[Enter]** on the numeric keypad input mode screen to confirm your selection.

Touch **[X]** to hide the keypad display.

- You cannot operate them while driving.

Displaying the Top Menu Screen (DVD-V) (V CD)

When a DVD contains two or more titles, the top menu screen appears.

Touch **[≡]** (**Top Menu**).

The top menu screen appears.

- To perform necessary operations, see "If a Menu Screen Appears" (page 72).

Displaying the Menu Screen (DVD-V) (V CD)

With a DVD having two or more menus, a menu screen will appear for the programs available, in addition to the main programs.

Touch **[≡]** (**Menu**).

The Root menu screen appears.

- To perform necessary operations, see "If a Menu Screen Appears" (page 72).

Playing Still Frames (Pausing) (DVD-V) (V CD)

- 1 During playback, touch **[▶ II]**.
- 2 Touch **[▶ II]** to resume playback.

- No sound is played during the still frame mode.
- The image or sound may stop temporarily when playback starts from the pause mode. This is not a malfunction.

Stopping Playback (DVD-V) (V CD)

Touch **[■]** during playback.

"■" indicator is displayed, and playback stops.

- Playback starts from the beginning when **[▶ II]** is touched while playback is stopped.

Fast-forwarding/Fast-reversing (DVD-V) (V CD)

- 1 During playback, touch and hold **[⏮]** (**Fast-reverse**) or touch and hold **[⏭]** (**Fast-forward**).

When pressed for more than 1 second, the disc is forwarded/reversed at double speed.

When held for 5 more seconds, the disc is forwarded/reversed at 8 times the normal speed.

When held for 10 more seconds, the disc is forwarded/reversed at 32 times the normal speed.

- 2 Release **[⏮]** or **[⏭]** to return to normal playback.

- No sound is played back during fast-forwarding/fast-reversing.
- On DVD mode, the menu screen may reappear during fast-forwarding/fast-reversing.
- This operation may not be possible on certain discs.

Finding the Beginnings of Chapters/Tracks/Files (DVD-V) (V CD)

During playback, touch **[⏮]** or **[⏭]**.

The chapter/track/file switches each time the button is touched, and playback of the selected chapter/track/file starts.

[⏭]: Touch this to start playback from the beginning of the following chapter, track or file.

[⏮]: Touch this to start playback from the beginning of the current chapter, track or file.

- Some DVDs do not have chapters.

Supplementary explanations

"Chapters" are divisions of movies or musical selections on DVDs.

"Tracks" are divisions of movies or musical selections on Video CD.

Forward/Reverse frame-by-frame Playback

DVD-V V CD

1 In the pause mode, touch [◀◀] or [▶▶].
The picture advances by one frame each time the button is touched.

2 Touch [▶ II] to return to normal mode.

- No sound is output during forward frame-by-frame playback.
- You can only execute reverse frame-by frame playback when playing DVD-V.

Repeat Playback

DVD-V V CD

Use this function to play the disc's titles, chapters or tracks, etc., repeatedly.

Touch [↺] to repeatedly play back.

The repeat mode switches every time the button is touched.

DVD Video

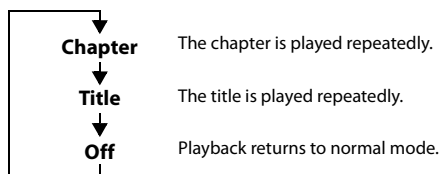

- The Repeat mode is always turned off when [↺] is touched and held for at least 2 seconds.
- Only discs containing a Playlist can be displayed.

Video CD

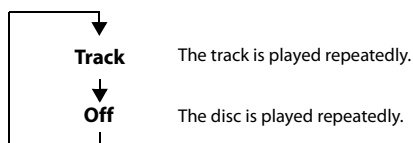

- Display may vary depending on the connected devices.
- For some discs it is not possible to switch the repeat mode.

Searching by Title Number

DVD-V

Use this function to easily find positions on the DVD using the DVD's titles. Perform operations while playback is stopped.

- 1 Touch [☰] (Menu Control).**
The menu operation mode screen appears.
- 2 Touch [Key] again in the menu operation mode.**
- 3 Enter a desired title by touching its number.**
See page 73 for operation of the numeric keypad.
- 4 Touch [Enter].**
Playback will start from the number selected.
- 5 Touch [X].**

- This function cannot be used on discs on which no title numbers are recorded.
- Some disc may not accept any operation.
- You cannot operate them while driving.

Searching Directly by Chapter Number

DVD-V V CD

Use this function to easily move to the beginnings of the chapters on the disc. Perform operations during playback, during PRE-STOP or while playback is paused.

- 1 Touch [☰] (Menu Control).**
The menu operation mode screen appears.
- 2 Touch [Key] again in the menu operation mode.**
- 3 Touch and enter the chapter number you want to play.**
See page 73 for operation of the numeric keypad.
- 4 Touch [Enter] to confirm your selection.**
Playback will start from the selected chapter.
- 5 Touch [X].**

- This function is not available for a disc on which chapters are not stored.
- You cannot operate them while driving.

Switching the Angle

DVD-V

On DVDs in which scenes have been filmed from multiple angles, the angle can be switched during playback.

Touch [☰] (Angle).

The angle switches between the angles recorded on the disc every time the button is touched.

- Some time may be required for the angle to change.
- Depending on the disc, the angle may switch in one of two ways.
 - Seamless: The angle switches smoothly.
 - Non-seamless: When the angle is switched, a still picture is displayed first, after which the angle switches.

Switching the Audio Tracks DVD-V V CD

DVDs with multiple audio tracks or languages allow switching the sound during playback.

Touch [] (Audio).

The sound switches between the alternate audio tracks recorded on the disc every time the button is touched.

- The alternate track selected becomes the default setting every time the power is turned on or the disc is replaced. If the disc does not include that track, the disc's default language is selected instead.
- Not all discs will allow changing the alternate audio tracks during playback. In these cases, select audio tracks from the DVDs menu.
- There may be a delay before the selected alternate track begins to play.

Video CDs with multiplex audio

Touch [] (Audio).

The left and right channels will be output as shown below, each time the button is touched.

Audio: LL → Audio: RR → Audio: LR → Audio: LL

Switching the Subtitles (Subtitle Language)

DVD-V

With DVDs on which multiple subtitle languages are recorded, the subtitle language can be switched during playback; moreover, subtitles can be hidden.

Touch [] (Sub Title).

Touching this button repeatedly selects sequentially the subtitle languages recorded on the disc, and then turns the subtitles OFF.

- There may be a delay before the selected subtitle appears.
- Not all discs will allow changing the subtitles during playback. In these cases, select subtitles from the DVDs menu.
- The subtitle language selected becomes the default setting every time the power is turned on or the disc is replaced. If the disc does not include that language, the disc's default language is selected instead. However, the subtitle language may differ depending on the disc.
- For some discs, the subtitles will be displayed even when this is set to OFF. However, the subtitle language may differ depending on the disc.

Info Mode Function

You can display the DISC information.

- 1 During playback, touch [] (Display).**
The playback status is displayed.

- 2 The playback status display closes when [] (Display) is touched.**

- For details on the display example, see Info mode in "DVD Video main screen example" (page 71) or "Video CD main screen example" (page 71).

Switching Display Modes

While your vehicle is parked, touch [WIDE] to display a popup list of Display Mode.

Select the desired mode from the list.

WIDE / CINEMA / NORMAL
(Mode 1) (Mode 2) (Mode 3)

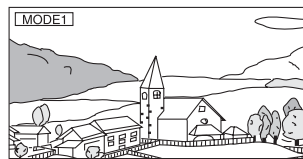

In Mode 1 (Wide), the monitor displays a normal picture wider to fit in a wide-screen monitor by evenly stretching out the picture horizontally.



In Mode 2 (Cinema), the monitor displays a normal picture by stretching out the picture horizontally and vertically. This mode is good for displaying a cinema type picture at the 16:9 ratio.



In Mode 3 (Normal), the monitor displays a normal picture at the center of the screen with a vertical black band at each side.

HDMI Operation

WARNING

It is dangerous for the driver to watch the HDMI image while driving the vehicle. The driver may be distracted from looking ahead and an accident may occur.

Install the unit correctly so that the driver cannot watch the HDMI image unless the vehicle is stopped and the emergency brake is applied.

If the unit is not installed correctly, the driver will be able to watch the HDMI image while driving the vehicle and may be distracted causing an accident. The driver or other people may be severely injured.

■ iPhone, Smartphone, etc.

The output of your electronic device will be mirrored on this unit through the HDMI connector. Control from this unit is not possible.

- The electronic device must possess an HDMI output interface.
- Not all devices with an HDMI output interface can be recognised by this unit.
- Use only the Alpine Special HDMI connection cable.

1 Press the (AUDIO) button to select HDMI mode.

The display shows the HDMI mode screen.

- You can select and change the source in the Menu screen (page 21) or Favorite screen (page 24).
- For your safety, video is not displayed and only audio can be heard while driving.

2 In HDMI player mode, the screen of the device displays the content of electronic equipment by mirror image.

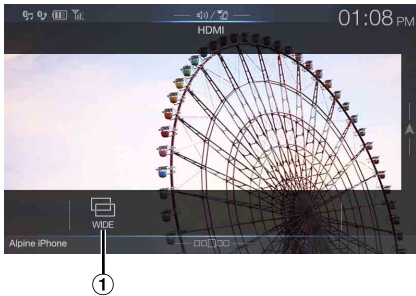

- ① You can select Display Mode.
For details, see "Switching Display Modes" (page 75).

- You cannot operate them while driving.

Switching the source when two HDMI devices are connected

You can switch the source only when you have connected the HDMI selector and "Setting the HDMI Selector On/Off" (page 48) is set to "On."

■ Screen example when the HDMI Setup is "HDMI 1"

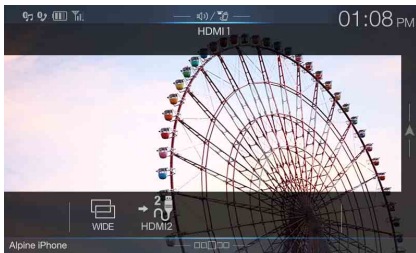

Touch [] (HDMI 2).

The HDMI source changes to HDMI 2, and the Function button changes to [] (HDMI 1).

Each time you touch [] (HDMI 1)* or [] (HDMI 2), the HDMI source changes.

* When HDMI Setup is "DVD," the Function button is changed to [] (DVD).

Bluetooth Operation

Setup Before Using

About Bluetooth

Bluetooth is a wireless technology allowing communication between a mobile device or personal computer over short distances. This enables a hands-free call or data transmission between Bluetooth compatible devices. Bluetooth transmission is available in the unlicensed 2.4 GHz spectrum if the distance between devices is within 10 meters. For details, refer to the Bluetooth website (<http://www.bluetooth.com/>).

- Depending on the Bluetooth version, a Bluetooth compatible device may not be able to communicate with this unit.
- Proper function of this unit with all Bluetooth compatible devices is not guaranteed. For handling of the Bluetooth compatible device, consult your Alpine dealer or Alpine website.
- Depending on the surroundings, Bluetooth wireless connection may be unstable.
- When you place a call, or perform setup operations, be sure to stop your car in a safe place.
- Depending on the connected Bluetooth compatible device(s), the function may differ. Also refer to the Owner's Manual of the connected device(s).

About the Hands-free Phone

Hands-free calls are possible when using a HFP (Hands-Free Profile) compatible mobile phone with this unit.

- Avoid performing a hands-free call in heavy traffic or on narrow or winding streets.
- Close the windows while calling to reduce background noise.
- If both calling parties are using hands-free devices, or the call is made in a noisy location, difficulty hearing the other person's voice is normal.
- Depending on telephone line conditions or certain mobile devices used, voices may sound unnatural.
- When using a microphone, speak as directly as you can into the microphone to obtain the best sound quality.
- Certain mobile phone features are dependent on the capabilities and settings of your service provider's network. Additionally, certain features may not be activated by your service provider, and/or the provider's network settings may limit the feature's functionality. Always contact your service provider about feature availability and functionality.

All features, functionality, and other product specifications, as well as the information contained in the Owner's Manual are based upon the latest available information and are believed to be accurate at the time of printing.

Alpine reserves the right to change or modify any information or specifications without notice or obligation.

- Notice that when you connect an iPhone 5 or later/Android smartphone which installed Android Auto App, the operation screen may differ from this section.

Before Using Bluetooth

Before using the hands-free phone/audio function, the following settings need to be made.

1 Set "Bluetooth" to "On" (☑).

2 Register a Bluetooth device in this unit (page 29).

- See "Bluetooth Setup" (page 29).
- You can search for this unit using a Bluetooth compatible device, and then connect that Bluetooth compatible device to this unit. The device name of this unit is "X409", "X308U" or "INE-W987HD" and the initial number of the passcode is "0000." Also refer to the Owner's Manual of the connected device(s).

Hands-free Phone Control

Touch [Phone] in the Menu screen to display the Phone menu screen (page 77).



[Phone] button

Phone menu screen example

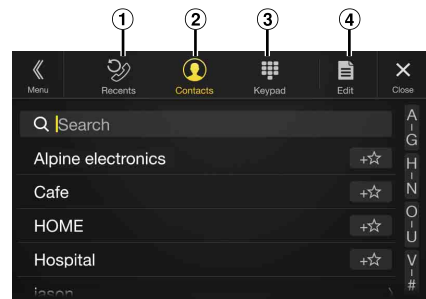

① Recent Events list*

You can display up to 60 items, such as phone numbers of the most recent incoming calls, missed calls and outgoing calls, and contact names that are registered in the Phone Book. When 60 items exist in the list, the oldest item is deleted when a further item is to be added.

② Contacts list*

You can make a phone call from the Phone Book, or edit the Phone book.

③ Keypad screen

Use to type a phone number.

④ Edit*

Use to edit the Contacts list.

* When you connect two Hands-Free Phones, the information of the Bluetooth device set to Primary is displayed.

Answering a Call

Incoming calls are announced by the received call ring tone and a displayed message (PHONE No., etc.).

1 An incoming call triggers the ringtone and an incoming call display.

Incoming call notification screen

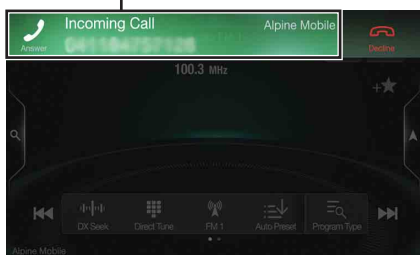

2 Touch incoming call notification screen.

The call starts.

Call info area

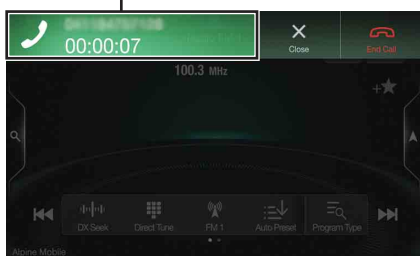

- During a call, the audio for the current mode on the unit is muted. After calling, playback will resume.
- When the caller's number is transmitted to the system, if the caller's name is stored in the phone book, the name is displayed. If the name is not stored, the number is displayed.
- Touch [Decline] to reject an incoming call.
- By touching the call info area during phone call, you can change to the Phone Operation screen and adjust the speech volume, etc. For details, see "Operations During a Conversation" (page 81).
- Touch [X] during a conversation to hide the call info area. To display it again, Touch or swipe downward on [Incoming Call] on the upper part of the screen.
- During an incoming call or a conversation on the Primary (Secondary) Hands-Free Phone, if there is an incoming call on the Secondary (Primary) Hands-Free Phone, you cannot answer the call on the Secondary (Primary) Hands-Free Phone without first ending the call on the Primary (Secondary) Hands-Free Phone.

Call Waiting Function

If a call comes in from another phone during a call, a notice is displayed on the screen. This function can only be used if the connected mobile phone has a call waiting function service included.

Second incoming call during a conversation in the call info area

Second incoming call notification screen

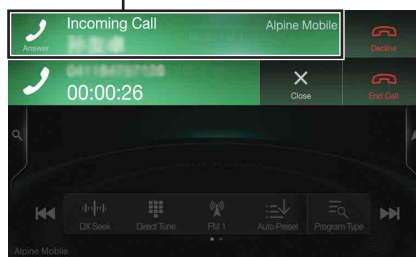

By touching the second incoming call notification screen, you can put the current call on hold and answer the second call.

On-hold screen

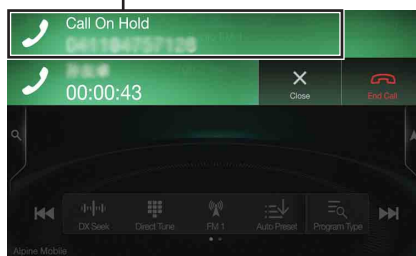

- To switch a party, touch the on-hold screen.
- To finish a call, touch [End Call].

Hanging up the Telephone

1 Touch [End Call].

The call finishes.

Second incoming call during a conversation in the Phone Operation screen

- The display or operation may differ depending on the connected mobile phone or the caller's mobile phone.

Second incoming call notification screen

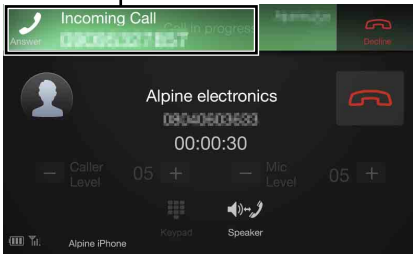

By touching the second incoming call notification screen, you can put the current call on hold and answer the second call.

Call On Hold screen

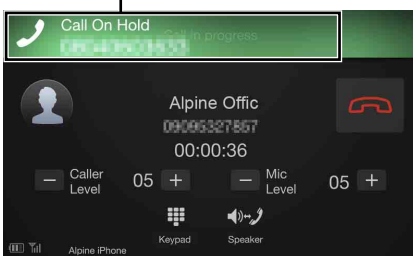

- To switch a party, touch the on-hold screen.
- To finish a call, touch [End Call].
- This unit supports only the Call Waiting function of a mobile phone. The second call function and three-way calling function of a mobile phone cannot be operated from this unit. Also the screen display may malfunction.

Calling

Calling by Favorite Function

You can make a phone call using the Short Cut function of numbers that have been registered in Favorite. For details, see "Favorite Function" (page 24).

- Press the ★ (Favorite) button.
The Favorite screen is displayed.

Favorite screen



- Touch the Short Cut icon.

A contact's name, phone number, and a confirmation message of the phone number are displayed.

- Touch [Call].

The phone call is started.

Making a phone call using the Phone Menu

Making a phone call from the Recent Events list

- Touch [Recent] (Recents) to change to the Recent Events list screen.

| Menu | Recents | Contacts | Keypad | Call | Close |
|------|--------------------|----------|--------|-------|-------|
| | Alpine electronics | | | 03/05 | 16:32 |
| | HOME | | | 03/05 | 14:25 |
| | Alpine Office | | | 02/24 | 14:04 |
| | 0123456789 | | | 02/20 | 14:59 |
| | Alpine Office | | | 02/20 | 14:02 |
| | Alpine Office | | | 02/20 | 13:54 |

Dialed history:

Names or Numbers/Date

Received history:

Names or Numbers/Date

Missed Incoming history:

Names or Numbers/Date

- Touch the name of the contact you want to call.

The Detail info screen is displayed.

- Touch [Call].

The phone call is started.

Calling from the Contacts list (Phone Book)

- Touch [Contacts] (Contacts) to change to the Contacts list screen.

- Touch the name of the contact you want to call.

The Phone Operation screen is displayed.

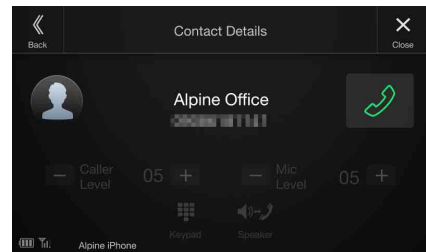

- Touch [Call].

The phone call is started.

Entering a Phone Number to Make a Call

1 Touch [⌨] (Keypad).

The number input screen (Keypad) appears.

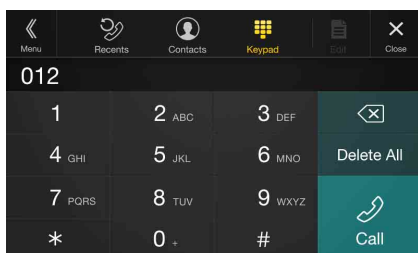

Touch [X] to delete an entered number.

Touch [Delete All] to delete all entered numbers.

2 Enter the phone number you wish to call.

- You can enter up to 31 digits.

3 Touch [📞] (Call).

A confirmation message of the phone number appears.

4 Touch [Call].

The phone call is started.

Using Voice Recognition function

You can use Siri function of your iPhone or make a telephone call by using voice operation of your smartphone.

- When using Apple CarPlay or Android Auto, the operation screen may differ from the screen design in the Owner's Manual.

Using Siri

You can use the Siri function of your iPhone. To use this function, set the Siri setting of your iPhone to ON.

- Connect your iPhone to the unit via Bluetooth, then set to "Hands-free" or "Both" (page 29).
- The available functions differ depending on the connected iPhone.
- Siri and other streaming services are enabled by connecting to compatible smartphones that are able to receive data. Please ensure that cellular data and/or Wi-Fi is turned on in the smartphone to enjoy these features.
- Extensive use of Siri or other streaming services may increase your phone's data usage. Please check with your phone company to ensure you have an appropriate Data plan.

1 Press [📞] or VOICE button.

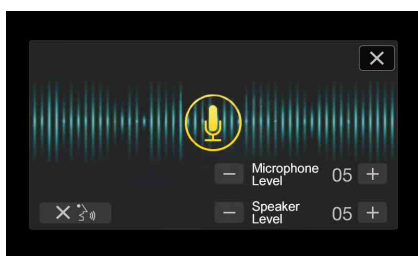

The Voice Control mode screen is displayed.

2 Speak into the microphone supplied with this unit.

- If no speech is detected, the unit may pause depending on version of the connected iPhone. In that case, touch the microphone icon [📞] in the center of the Voice Control mode screen. You can continue to use the Voice Control mode.

3 To finish the Voice Control mode, touch [X] or press [📞] or VOICE button.

- Depending on the iPhone, the Siri function may finish automatically.

Adjusting the volume

Adjust the speaker/microphone volumes in Voice Control mode.

Perform the same procedure to adjust the speaker/microphone volumes of hands-free phone.

Touch [-] or [+].

Adjust the speaker and microphone volumes.

Stopping input to the microphone

If the surrounding sound (road noise, etc.) is loud, you may wish to cut input to the microphone for 3 seconds.

Touch [X 📞].

Voice Dial Function

You can make a telephone call by using voice operation.

- Connect your smartphone to the unit via Bluetooth, then set to "Hands-free" or "Both" (page 29).

1 Press [📞] or VOICE button.

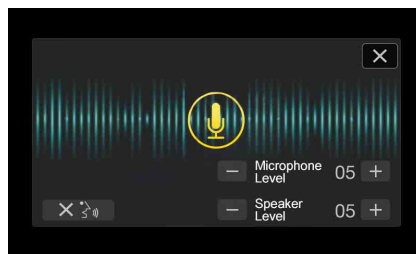

The Voice Dial mode screen is activated.

2 Say the telephone number* or name* you want to call, into the microphone.

- * The number and name depend on the voice dial information stored in the smartphone.

3 To finish the Voice Dial mode, touch [X] or press [📞] or VOICE button.

- You can perform this operation only when a voice dial compatible smartphone is connected.
- The Voice Dial function performance depends on the recognition range of the smartphone and mounting location of the microphone. Note when the microphone is mounted.
- Voice dial operation depends on the function being available on the smartphone. For details, refer to the owner's manual of the smartphone.
- Depending on the smartphone, the Voice Dial operation may finish automatically.

Adjusting the volume

Adjust the speaker/microphone volume in Voice Dial mode. Perform the same procedure to adjust the speaker/microphone volume of hands-free phone.

Touch [–] or [+].

Adjust the speaker and microphone volumes.

Stopping input to the microphone

If the surrounding sound (road noise, etc.) is loud, you may wish to cut input to the microphone for 3 seconds.

Touch [X] [🔊].

Operations During a Conversation

Phone Operation screen

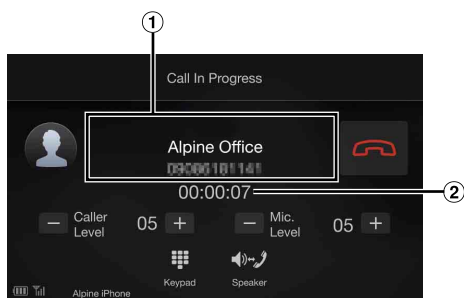

- 1 Name and phone number
 - If registered with a Group, the Group Name is also displayed. Although, depending on the connected mobile phone, it may not be displayed.
- 2 Conversation time

Adjusting the Speech Volume

You can adjust Caller Level and Mic. Level (Microphone Level) during a phone call.

Touch [–] or [+].

You can adjust the Caller volume in 35 levels and Microphone volume in 11 levels.

Changing the Voice Output

The voice output for calls is switchable between car speakers and the mobile phone speaker.

Touch [🔊] (Speaker).

- Depending on the mobile phone, this operation may not be possible.

DTMF (Touch-Tone) Function

Transmits a DTMF (Touch-Tone) during a call.

1 Touch [🔑] (Keypad).

The number input screen (Keypad) appears.

2 Input number.

- You can transmit a Touch-Tone signal during a call.

Phone Book Function

Phone Book screen example

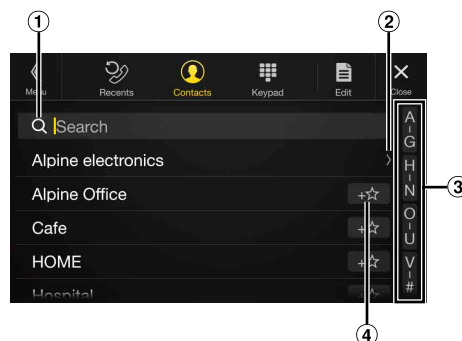

- 1 Use to search by directly inputting a name or phone number with the Keypad.
For details, see "How to Input Characters and Numbers (Keypad)" (page 23).
- 2 Displayed when multiple phone numbers are registered. Touch [>] to display the registered phone number list.
- 3 Use to narrow down your search for names, etc.
For details, see "Alphabet Search Function" (page 60).
- 4 Touch [+★] to register as Favorite.

Synchronizing the Phone Book

You can synchronize the system's phone book with the mobile phone's phone book.

1 Touch [📄] (Edit).

2 Touch [Download].

3 Touch [Sync].

Synchronization of the phone books starts.

- You can store up to 1,000 registered name in the phone book.
- You can store up to 5 phone numbers by one person's name.

Adding the Phone Book

1 Touch [📄] (Edit).

2 Touch [Download].

3 Touch [Add].

Stays on standby for connection of the mobile phone.

- Touch [Cancel] to cancel the standby mode.

4 The mobile phone accesses this unit and then transfers the phone book from the mobile phone to this unit.

- Mobile phone connection is canceled while the phone book is being transferred.

Deleting the Phone Book Entries

Deleting One Entry from the Phone Book

- 1 Touch [Edit].
- 2 Touch the checkbox [] of the contact name (or phone number) you want to delete. A tick [] appears in the checkbox.
 - You can choose up to 10 names and numbers at a time.
- 3 Touch [Delete].
The confirmation screen is displayed.
If multiple phone numbers are registered, they are all deleted.
- 4 Touch [OK].
The selected number is deleted.

Deleting All Entries from the Phone Book

- 1 Touch [Edit].
- 2 Touch [Delete All].
The confirmation screen is displayed.
- 3 Touch [OK].
All entries of the phone book are deleted.

Searching in the Phone Book

You can make a call using the phone book search function.

- 1 Touch [Search].
The Input User Name screen (Keypad) is displayed.
 - 2 Input the string of letters of the name that you want to search, then touch [OK].
A list of names beginning with the string of letters you entered is displayed.
 - 3 Touch the name you want to call.
The Phone Operation screen is displayed.
 - 4 Touch [Call].
The phone call is started.
- For details of how to input characters using the keypad, see "How to Input Characters and Numbers (Keypad)" (page 23).
 - If there are fewer than five registered items in the phone book, you cannot use the phone book search function.

Bluetooth Audio

If a Bluetooth compatible mobile phone, portable player, etc. is connected by wireless, you can play back a song (operation is controllable from the unit).

- Operation may vary, depending on the Bluetooth compatible device.

Bluetooth Audio main screen example



Function mode

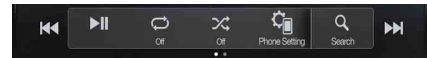

- ① Current track no./Total song no.
- ② Artist title
- ③ Song title
- ④ Album title
- ⑤ Elapsed time
- ⑥ Touch to use the Quick Search mode and Full Search mode.
- ⑦ Full Search button
Touch when using Full Search mode.

Quick Search mode screen example

Swipe vertically in the list to change pages.



- ⑧ Touch to close the Quick Search mode.
- The displayed onscreen buttons may differ depending on the AVRCP version.
 - Song title/Artist title/Album title/Elapsed time do not display for AVRCP Ver. 1.0.
 - To play back audio, a mobile phone or a portable player conforming to A2DP (Advanced Audio Distribution Profile) or AVRCP (Audio/Video Remote Control Profile) is required.
Not all functions work with all devices.
 - During a call, sound on the Bluetooth audio source is paused.

Compatible AVRCP versions: 1.0, 1.3, 1.4, 1.5

- Available functions may differ depending on the AVRCP version.

Playback

1 Press the (AUDIO) button to select Bluetooth Audio mode.

The display shows the Bluetooth Audio mode screen.

- You can also select and change the source in the Menu screen (page 21) or the Favorite screen (page 24).

2 Touch [] or [] to select the desired track (file).

Returning to the beginning of the current file:

Touch [].

Fast backward the current file:



Touch and hold [].

Advance to the beginning of the next file:

Touch [].

Fast forward the current file:

Touch and hold [].

- The ,  buttons provide the same functions above.

3 To pause playback, touch [II].

- Operations may differ depending on the connected Bluetooth compatible device.

Repeat Play

Available for AVRCP Ver. 1.3, 1.4 and 1.5 only.

1 Touch [].

The Repeat mode select pop up screen is displayed.

- [] displays the currently selected mode.

2 Select your desired Repeat mode.

The selected Repeat mode changes the button.

All Track : Once all of the songs have finished playing, play back is repeated, starting with the first song.

Group : Only files in a group are repeatedly played back.

Single Track : Only the track currently playing is repeatedly played back.

Off : Repeat mode Off.

- Operations may differ depending on the connected Bluetooth compatible device.

Random Play

Available for AVRCP Ver. 1.3, 1.4 and 1.5 only.

1 Touch [].

The Random Play mode select pop up screen is displayed.

- The [] button displays the currently selected mode.

2 Select your desired Random Play mode.

The selected Random Play mode changes the button.

All Track : All songs in the Bluetooth compatible devices are played back in random sequence. Any one song does not play back again until all songs have been played back.

Group : A Group is selected randomly and songs in the Group are played back in order. After all songs are played in the Group, the next Group is selected randomly.

Off : Random mode Off.

- Operations may differ depending on the connected Bluetooth compatible device.

Search Function

Available for AVRCP Ver. 1.4 and 1.5 only.

The displayed list differs with the connected Bluetooth device.

You can search for your desired song by using one of two modes; the Quick Search mode and the Full Search mode.

Quick Search mode

Touch your desired Group name or File name.

The selected Group*1 or file is played back.

*1 The first file in the selected Group is played back.

- To switch into Quick Search mode, see ⑥ in "Bluetooth Audio main screen example" (page 82).

Full Search mode

Touch your desired Group name*2 or File name.

When you select a File name, the selected song is played.

When you select a Group name, repeat the same procedure to select another Group name or File name.

*2 When you touch the [] by a Group name, the unit plays from the first song in the Group.

- To switch into Full Search mode, see ⑧ in "Bluetooth Audio main screen example" (page 82).
- To switch the displayed list or return to the previous page in the List screen, see "About Basic Operation for List Screen" (page 18).

Connecting a Bluetooth Device

Registering a Bluetooth device in the unit enables automatic connection. If it does not connect automatically, run through the connection procedure again.



- 1 Touch [] (Settings).**
The Device Setting select pop up screen is displayed.
- 2 Touch [Reconnect].**
Bluetooth connection will start.

Disconnecting the Bluetooth Connection

- 1 Touch [] (Settings).**
The Device Setting select pop up screen is displayed.
- 2 Touch [Disconnect].**
The Bluetooth connection is disconnected.

Changing the connecting Bluetooth Device

If multiple Bluetooth devices are registered in this device, you can change the connection among the registered devices.

- 1 Touch [] (Settings).**
- 2 Touch [Change].**
- 3 Touch [] (Audio) or [] (Hands-free) of the selected device.**
The connection will transfer to the selected device.

Auxiliary Device (Optional)

Operating Auxiliary Devices (Optional)

To operate devices connected to the AUX terminals of the unit, follow the procedure described below.

- Set AUX to “On.” See “AUX Setup” (page 43).
- Depending on the connected unit, the onscreen buttons may not work, or their operation may differ.
- When the iDataLink module (sold separately) is connected, the Auxiliary (AUX) mode is not available.



WARNING

It is dangerous (and illegal in many states) for the driver to watch TV/video while driving the vehicle. The driver may be distracted from looking ahead and an accident could occur.

Install the unit correctly so that the driver cannot watch TV/video unless the car is stopped and the parking brake is applied.

If the unit is not installed correctly, the driver will be able to watch TV/video while driving and may be distracted from looking ahead and cause an accident. The driver or other people could be severely injured.

Press the  (AUDIO) button to select Auxiliary (AUX)* mode. The display shows the Auxiliary (AUX) mode screen.

* The name which is given as the mode name in “Setting the Auxiliary (AUX) Name” (page 43) is displayed.

- For your safety, video is not displayed and only audio can be heard while driving.
- You can select and change the source in the Menu screen (page 21) or Favorite screen (page 24).
- For details on the connected auxiliary device, refer to its owner’s manual.

AUX Operation Screen Display During Video File Playback

Touch the screen.

The Auxiliary (AUX) operation screen is displayed.

- The operation screen changes to the visual screen in the Auxiliary (AUX) mode for 5 seconds after an operation has been performed. To hide the Auxiliary (AUX) operation screen, touch the video display area.

Operating an AUX, AUX DVD or GAME

Example for AUX, AUX DVD, GAME mode display

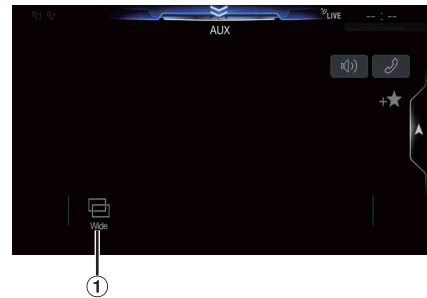

- 1  (Display Mode)

For details, see “Switching Display Modes” (page 75).

- You cannot operate them while driving.

Operating an External DVD Player

External DVD player display example

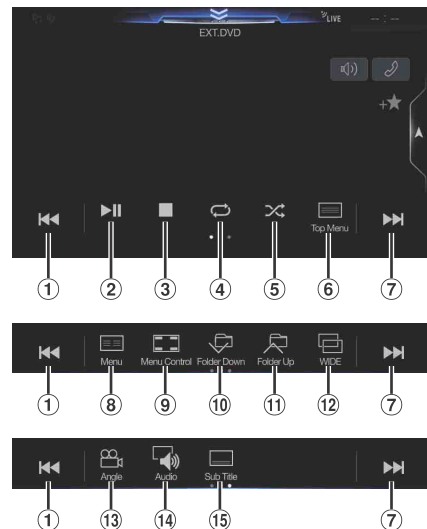

- 1 

Touch the switch to go back to the beginning of the current chapter/track/file. Touch the switch once more to find the beginning of the previous chapter/track/file. Touch and hold to fast reverse.

- 2 

Switches between play and pause.

- 3 

Touching during play initiates a pre stop. Touching again stops play.

- 4 

Starts/Stop repeat play.

- 5 

Starts/Stop M.I.X. play.

- 6 

Calls up the Top Menu screen.

- ⑦ [▶▶] Touch the switch to advance to the beginning of the next chapter/track/file. Touch and hold to fast forward.
- ⑧ [☰] (Menu) Calls up the Menu screen.
- ⑨ [☰] (Menu Control)* Calls up the menu operation mode.
- ⑩ [⏴] (Folder Down) Switches the program/playlist/folder down.
- ⑪ [⏵] (Folder Up) Switches the program/playlist/folder up.
- ⑫ [☰] (Display Mode)* You can set the Display Mode. For details, see "Switching Display Modes" (page 75).
- ⑬ [📐] (Angle) Switches angle.
- ⑭ [🔊] (Audio) Switches audio.
- ⑮ [☰] (Sub Title) Switches sub titles.

* You cannot operate them while driving.

■ Menu operation mode screen example

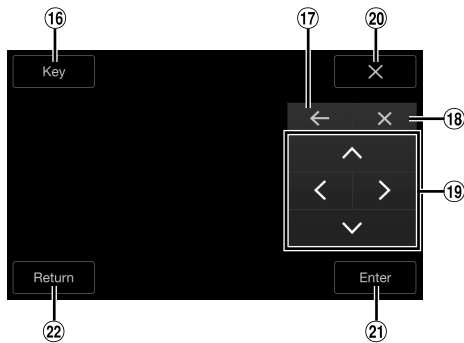

- ⑬ [📐] (Angle) Switches angle.
 - ⑭ [🔊] (Audio) Switches audio.
 - ⑮ [☰] (Sub Title) Switches sub titles.
 - ⑯ [☰] (Menu Control)* Calls up the menu operation mode.
 - ⑰ [☰] (Menu) Calls up the Menu screen.
 - ⑱ [▶▶] Touch the switch to advance to the beginning of the next chapter/track/file. Touch and hold to fast forward.
 - ⑲ [⏴] (Folder Down) Switches the program/playlist/folder down.
 - ⑳ [⏵] (Folder Up) Switches the program/playlist/folder up.
 - ㉑ [☰] (Display Mode)* You can set the Display Mode. For details, see "Switching Display Modes" (page 75).
 - ㉒ [📐] (Angle) Switches angle.
 - ㉓ [🔊] (Audio) Switches audio.
 - ㉔ [☰] (Sub Title) Switches sub titles.
- ⑩ [Key] Displays the Key panel (⑪ ⑫ ⑬).
 - ⑪ [←], [→] Moves key panel location.
 - ⑫ [X] Closes menu operation mode.
 - ⑬ [X] Closes key panel.
 - ⑭ [↑], [↓], [←], [→] Moves menu cursor.
 - ⑮ [Enter] Determines the selected item.
 - ⑯ [Return] Returns to the previous item/screen.

Camera Operation (Optional)

When an optional camera is connected, the video of the camera's view can be output to the monitor.

Front camera, Rear camera or Side camera can be connected to this unit. Make the Camera Select setting (Front, Rear, Side or Other) according to your connected camera. For details, see "Setting the Camera Input" (page 45).

When using the optional Multi Camera Interface module, you can connect up to 3 cameras: Front Camera, Rear Camera, and Side Camera. When connecting the optional Multi Camera Interface module, you need to set each camera to On/Off in "Setting Multi Camera to On/Off" (page 47).

When displaying the camera view while connected to the optional Multi Camera Interface module, you can switch the camera view using the switch button at the top of the screen.

For X409, when Off-Road is set to On (page 27), Off-Road Camera can be displayed. The Off-Road information is displayed on the Off-Road Camera screen.

Front camera:

When the HCE-C257FD is connected, conditions in front of the vehicle, such as objects, people and other hazards, can be seen.

Rear camera:

If an HCE-C127D/HCE-C157D/HCE-C252RD camera is connected, when the vehicle is reversed, the rear camera view (guide marks for vehicle width and available distance) is displayed automatically on the screen of this unit.

Other camera:

Set when connecting to a camera other than the Front camera or Rear camera, such as a room camera and side camera.

You can adjust the quality of the camera image.

Setting items: Brightness / Color / Contrast
See "Picture Quality Setup" (page 37).

Rear Camera Operation

Displaying the Rear Camera Image from the Menu screen

1 Press the **MENU** button.

The menu screen is displayed.



2 Touch **[Camera]**.

The Rear Camera view is displayed.

- Touch the screen while the camera image is being displayed, and touch [X] or [◀] to return to the main source screen or previous screen.
- You can perform a Guide Adjustment. For details, see "Adjusting the Rear/Front/Side Camera Guide" (page 45).
- If you connect a Front Camera and Side Camera using the optional Multi Camera Interface module, you can display the Rear camera image using the [Camera] button only when you set "Setting a Default Camera" (page 47) to "Rear". If you connect a Front Camera and Side Camera at the same time, touch [Front] or [Side] in the Rear Camera image to switch the Camera image.

Displaying the rear view video while the car is in reverse

Shift the gear lever to the reverse (R) position.

The rear view image is displayed while the car remains in reverse.

- Never depend solely on the camera when backing up. Always turn and look and only use the camera for additional assistance.
- This function is effective when the reverse wire is properly connected.
- If you use the optional Multi Camera Interface module, be sure to set Rear Camera in "Setting Multi Camera to On/Off" (page 47) to "On" (☑). If setting to "Off" (☐), you cannot display the Rear camera image.
- If you set to Front or Side in "Setting a Default Camera" (page 47), the Rear camera image is also displayed.
- You can perform a Guide Adjustment. For details, see "Adjusting the Rear/Front/Side Camera Guide" (page 45).

Switching the Image for the Rear Camera

If the camera has a view switch function, the Direct Change switch is displayed.

1 Touch the screen when the image from the rear camera is displayed.

The operation screen is displayed on the screen.

- After a 5-second time-out, the operation screen returns to the camera display screen.

2 Touch **[Back]**, **[Panorama]**, **[Corner]** or **[Top]**.

The image pattern changes.

| | |
|-------------|---------------|
| [Back]: | Rear View |
| [Panorama]: | Panorama View |
| [Corner]: | Corner View |
| [Top]: | Ground View |

- For detailed information about image patterns, see the camera Owner's Manual.
- You can perform a Guide Adjustment. For details, see "Adjusting the Rear/Front/Side Camera Guide" (page 45).

Guide Display ON/OFF Setting

1 Touch the screen when the image from the camera is displayed.

The operation screen is displayed on the screen.

- After a 5-second time-out, the operation screen returns to the camera display screen.

2 Touch **[Guide Off]** or **[Hitch Guide Off]** on the Rear camera display screen.

The guide disappears, and then the [Guide Off] or [Hitch Guide Off] switch changes to [Guide On] or [Hitch Guide On].

3 Touch **[Guide On]** or **[Hitch Guide On]** to turn on the guide.

Adjusting the Caution Display Location

1 Touch the screen when the image from the camera is displayed.

The operation screen is displayed on the screen.

- After a 5-second time-out, the operation screen returns to the camera display screen.

2 Touch [⬆️ Caution].

- For each touch, the caution location moves to the top or bottom of the screen.

About the Rear Camera Guide

To display the guide, set "Guide Display ON/OFF Setting" (page 87) to On. Also, to adjust the guide, see "Adjusting the Rear/Front/Side Camera Guide" (page 45). You can also turn off the guide in the Rear camera display screen.

■ Indication mark meaning

When the car is put into reverse gear, the monitor switches to the rear view camera image. Guides appear to help visualize the car's width and distance from the rear bumper.

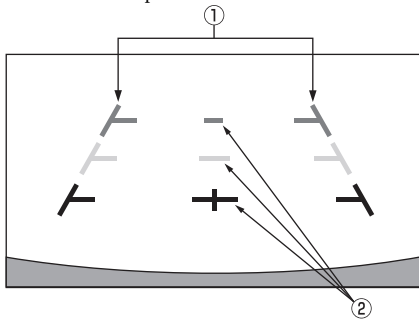

① Car width extension marks (red, yellow and green in order of distance)

If properly calibrated, the marks indicate the car's width. This helps guide the car's path when backing up in a straight line.

The marks represent the distance from the rear of the car (from the rear end of the bumper).

- The marks do not move in synchronization with the steering wheel.
- Set the marks to suit the car's width.

② Distance guidance marks

The marks represent the distance from the rear of the car (from the rear end of the bumper).

- The marks do not move in synchronization with the steering wheel.
- We recommend that you measure the actual distance to the marks when parked on a level surface.
- Depending on the condition of the car or road surface, the range of vision may vary.
- The camera has a limited range of vision. Objects at extreme angles to the camera (e.g. under the bumper or at opposite ends of the bumper) may not be in its field-of-vision.
- The rear camera image may have a tint which is different from the actual surroundings.
- Depending on the car, the guidance may deviate to the right or left. This is not a malfunction.

■ Distance guidance mark

The distance guides represent the ground level distance from the rear bumper. It is difficult to accurately estimate the distance to objects above ground level.

In the following example, the distance to A is 0.5 m and the distance to B is 1 m.

<Screen>

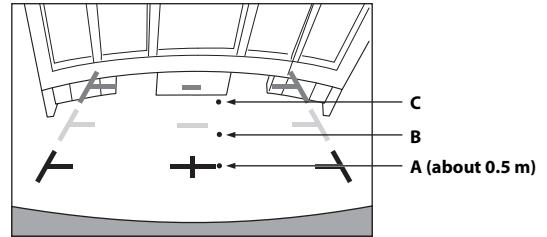

<Positions of A, B and C>

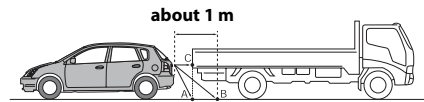

In the screen, according to the distance guidance marks, the truck seems to be parked about 1 m away (at the position B). In actual fact, however, if you reversed to position A, you would collide with the truck.

In the screen, positions A, B and C seem to be located in order of proximity. However, in actual fact, the position A and C are the same distance, and B is farther away than positions A and C.

- The car width extension mark represents the distance to the road surface. The distance to an object on the road is not accurately represented by the guides.

Error between the screen and the actual road surface

In the following conditions, errors are produced between the screen guidance and the actual road surface. (The illustrations represent a case when the camera is installed in the standard position.)

■ When there is a steep upward slope behind the car (example)

<Screen>

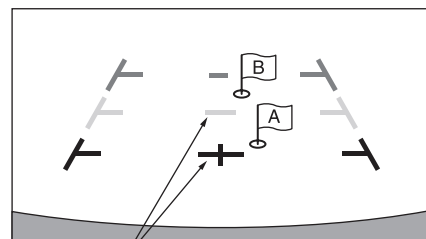

Distance guidance marks

<Situation of the car>

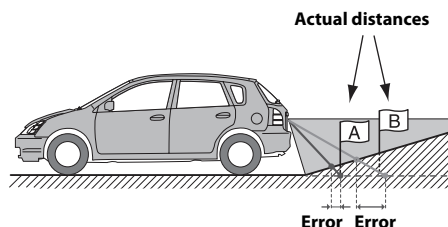

The distance guidance mark represents the distance to a flat road surface. Therefore in the case of an upward slope behind the car, the distance guides are displayed closer to the rear bumper than the actual distance. For example, if there is an obstacle on the upward slope, it may appear farther away than its actual position.

Also, an error may occur between the guidance and the actual path of the car on the road surface.

■ When there is a steep downward slope behind the car (example)

<Screen>

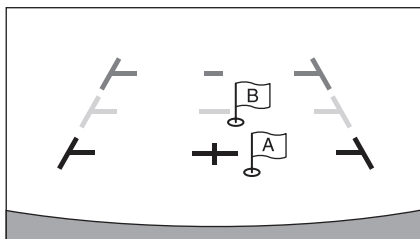

<Situation of the car>

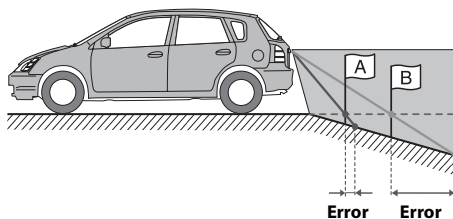

In the case of a downward slope behind the car, the distance guides are displayed farther from the rear bumper than the actual distance.

If there is an obstacle on the downward slope, it seems closer than its actual position.

Also, an error may occur between the guidance and the actual path of the car on the road surface.

Front Camera Operation

Displaying the Front Camera image from the Menu screen.

- 1 Press the **MENU** button.
The menu screen is displayed.



[Camera] button

- 2 Touch **[Camera]**.
The Front Camera view is displayed.

- Touch the screen while the camera image is being displayed, and touch [X] or [◀] to return to the main source screen or previous screen.
- You can perform a Guide Adjustment. For details, see "Adjusting the Rear/Front/Side Camera Guide" (page 45).
- If you connect a Front Camera using the optional Multi Camera Interface module, you can display the Front camera image using the [Camera] button only when you set "Setting a Default Camera" (page 47) to "Front". If you connect a Rear Camera and Side Camera at the same time, touch [Rear] or [Side] in the Rear Camera image to switch the Camera image.

Switching the Image Pattern for the Front Camera

If the camera has a view switch function, the Direct Change switch is displayed.

- 1 Touch the screen when the image from the front camera is displayed.

The operation screen is displayed on the screen.

- After a 5-second time-out, the operation screen returns to the camera display screen.

- 2 Touch **[Panorama]**, **[Corner]** or **[Top]**.

The image pattern changes.

[Panorama]: Panorama View

[Corner]: Corner View

[Top]: Ground View

- For detailed information about image patterns, see the camera Owner's Manual.
- You can perform a Guide Adjustment. For details, see "Adjusting the Rear/Front/Side Camera Guide" (page 45).

About the adjustment of guide display ON/OFF setting and adjustment of Caution display location

As with the rear camera, the front camera guide display ON/OFF setting and Caution display location can be adjusted. See “Guide Display ON/OFF Setting” (page 87) and “Adjusting the Caution Display Location” (page 88) for the operations.

Side Camera Operation

Displaying the Side Camera image from the Menu screen.

- 1 Press the **MENU** button.
The menu screen is displayed.



[Camera] button

- 2 Touch **[Camera]**.
The Side Camera view is displayed.
 - Touch the screen while the camera image is being displayed, and touch [X] or [K] to return to the main source screen or previous screen.
 - You can perform a Guide Adjustment. For details, see “Adjusting the Rear/Front/Side Camera Guide” (page 45).
 - If you connect a Side Camera using the optional Multi Camera Interface module, you can display the Side camera image using the [Camera] button only when you set “Setting a Default Camera” (page 47) to “Side”. If you connect a Rear Camera and Front Camera at the same time, touch [Rear] or [Front] in the Rear Camera image to switch the Camera image.

Switching the Image Pattern for the Side Camera

If the camera has a view switch function, the Direct Change switch is displayed.

- 1 Touch the screen when the image from the side camera is displayed.
The operation screen is displayed on the screen.
 - After a 5-second time-out, the operation screen returns to the camera display screen.

- 2 Touch **[Rear]** or **[Front]**.
The image pattern changes.
 - Rear: Vehicle Rear view
 - Front: Vehicle Front view

- For detailed information about image patterns, see the camera Owner's Manual.
- You can perform a Guide Adjustment. For details, see “Adjusting the Rear/Front/Side Camera Guide” (page 45).

Off-Road Camera Operation (X409 only)

When Off-Road Mode is On, Off-Road Camera can be activated.

Off-Road Rear Camera Operation

Displaying the Off-Road Rear Camera screen

- 1 Press the **MENU** button.



[Camera] button

- 2 Touch **[Camera]**.
The Off-Road Camera screen is display.
 - You can activate Off-Road Camera by pressing the [Source/Camera View] button once. This requires “Off-Road SWRC” to be set to “Camera”. For details, see “Off-Road SWRC Settings (X409 only)” (page 40).
 - If you connect an optional Multi Camera Interface module, when the gear lever is shifted to the reverse (R) position and the reverse image is displayed, you can touch [CAM]/[VIEW] to switch camera or image pattern.

Multi-view camera display example

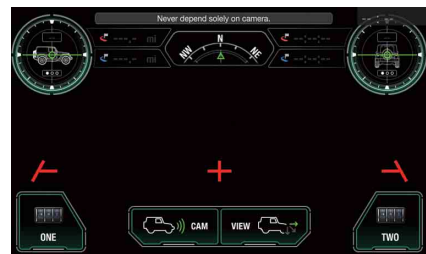

Changing the Off-Road Camera View





If a multi-view camera is connected, a [VIEW] button to cycle the view (Panorama/Back/Top/Corner) will be displayed at the bottom of the camera screen.

1 Touch the camera screen while the Off-Road Camera screen is active.

The multi-view camera and accessory controller buttons become visible. (Only if these accessories are connected.)

- The camera and accessory controller buttons will be cleared from the camera screen after 5 seconds of no interaction.

2 Touch [VIEW] to cycle the camera view.

-  Panorama View
-  Back View
-  Top View
-  Corner View

- You can also cycle the camera view by pressing the [Source/Camera View] button on the steering wheel, only when you set "Off-Road SWRC Settings" to "Camera". For details, see "Off-Road SWRC Settings (X409 only)" (page 40).

Off-Road Front Camera Operation

Displaying the Off-Road Front Camera screen

1 Press the MENU button.



[Camera] button

2 Touch [Camera].

The Off-Road Front Camera view is displayed.

- You can also activate the Off-Road front camera by pressing the [Source/Camera View] button on the steering wheel, only when you set "Off-Road SWRC Settings" to "Camera". For details, see "Off-Road SWRC Settings (X409 only)" (page 40).

Changing the Front Off-Road Camera View



The [VIEW] button displays if a multi-view camera is connected.

1 Touch the camera screen while the Off-Road front camera screen is active.

The multi-view camera and accessory controller buttons become visible. (Only if these accessories are connected.)

- The camera and accessory controller buttons will be cleared from the camera screen after 5 seconds of no interaction.

2 Touch [VIEW] to change the camera view.

-  Panorama View
-  Top View
-  Corner View

- You can also cycle the Off-Road Camera view by pressing the [Source/Camera View] button on the steering wheel, only when you set "Off-Road SWRC Settings" to "Camera". For details, see "Off-Road SWRC Settings (X409 only)" (page 40).

Off-Road Side Camera Operation

Displaying the Off-Road Side Camera screen

1 Press the MENU button.



[Camera] button

2 Touch [Camera].

The Off-Road Side Camera view is displayed.

- You can also activate the Off-Road side camera by pressing the [Source/Camera View] button on the steering wheel, only when you set "Off-Road SWRC Settings" to "Camera". For details, see "Off-Road SWRC Settings (X409 only)" (page 40).

Changing the Side Off-Road Camera View



The [VIEW] button displays if a multi-view camera is connected.

1 Touch the camera screen while the Off-Road side camera screen is active.

The multi-view camera and accessory controller buttons become visible. (Only if these accessories are connected.)

- The camera and accessory controller buttons will be cleared from the camera screen after 5 seconds of no interaction.

2 Touch [VIEW] to change the camera view.

-  Rear View
-  Front View

- You can also cycle the Off-Road Camera view by pressing the [Source/Camera View] button on the steering wheel, only when you set "Off-Road SWRC Settings" to "Camera". For details, see "Off-Road SWRC Settings (X409 only)" (page 40).

Changing the Camera Source



The [CAM] button will be displayed at the bottom of the camera screen when the Alpine multi-camera selector (KCX-C250MC) is connected.

1 Touch the camera screen while the Off-Road Camera screen is active.

The multi-view camera and accessory controller buttons become visible. (Only if these accessories are connected.)

- The camera and accessory controller buttons will be cleared from the camera screen after 5 seconds of no interaction.

2 Touch [CAM] to cycle the camera source.

- : Off-Road Front Camera
- : Off-Road Rear Camera
- : Off-Road Side Camera

About the Off-Road Camera information

When the Off-Road Camera screen is displayed, Guidelines display when the Off-Road Camera screen is active.

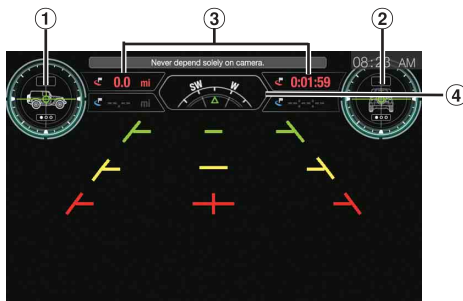

1 Vehicle Pitch angle

If properly calibrated, the value represents the vehicle pitching angle.

When the Pitching angle is greater/lower than Inclinator set value, alert is displayed.

- Green Normal:** When the vehicle's pitching angle lower than the lower limit Alarm value.
- Yellow Low Alert:** When the vehicle's pitching angle equal or over the lower limit Alarm value, but lower than the upper limit Alarm value.
- Red High Alert:** When the vehicle's pitching angle equal or over the upper limit Alarm value.

- Long press Vehicle Pitching angle area, Inclinator Setup is displayed when your vehicle is parked.
- The Pitching angle data is from iDataLink.
- For alert value setting, see "Inclinator Setup (X409 only)" (page 40).

2 Vehicle Roll angle

If properly calibrated, the value represents the vehicle rolling angle.

When the Rolling angle is greater/lower than Inclinator set value, alert is displayed.

- Green Normal:** When the vehicle's rolling angle lower than the lower limit Alarm value.
- Yellow Low Alert:** When the vehicle's rolling angle equal or over the lower limit Alarm value, but lower than the upper limit Alarm value.
- Red High Alert:** When the vehicle's rolling angle equal or over the upper limit Alarm value.

- Long press Vehicle Rolling angle area, Inclinator Setup is displayed when your vehicle is parked.

- The Rolling angle data is from iDataLink.
- For alert value setting, see "Inclinator Setup (X409 only)" (page 40).

3 Tracking, Back Tracking information

When tracking: Top: the distance/Time of tracking
Below: ---/--:---

When Back Tracking: Top: the distance/Time of Back Tracking
Below: the distance/Time of tracking before Back Tracking

4 Compass with direction of travel arrow

The vehicle position information is displayed.

There are 16 compass points in total: N, NE, E, SE, S, SW, W, NW, NNW, NWW, SSE, SSW, NNE, NEE.

Touch 1 or 2 to switch display contents.



5 Battery Voltage

6 Latitude/Longitude

Touch 1 or 2 to switch display contents.

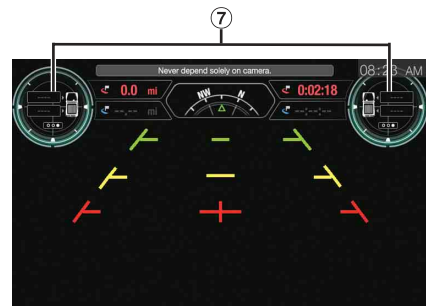

7 Tire Pressure

The Tire Pressure for Front-Left/Rear-Left/Front-Right/Rear-Right is displayed.



⑧ **The first two control switches from External Accessory screen***

The first two items of information from External Accessory screen are displayed in the lower left and right of the camera screen.

For details on External Accessory screen, see "External Accessory Control Operation" (page 96).

* Displayed only when iDataLink module is connected.

- The Off-Road Camera guide line is same as the normal camera guide line.
- For Off-Road Camera, there is no [Guide On/Off], [⚠ Caution], [Hitch Guide On/Off], [✕] and [⏪] displayed on the camera screen.

iDataLink Operation

When the unit is connected to the car's iDataLink module, you can transfer and receive data between the car and the unit to check the car's status, or to make various operations from the unit.

When you use iDataLink mode, set each setting other than "Aftermarket" in "Setting the Source Category" (page 47).

- An iDataLink module (sold separately) is required.
- Available functions differ depending on your vehicle. For details, refer to your vehicle's instruction manual.

About Audio Interrupt

Audio Interrupt is the function that outputs sound from the unit when Voice Information (audio reading from the phone book, etc.)* from the vehicle occurs.

- The Audio Interrupt function of the vehicle differs depending on the type and grade of the vehicle.

* For your safety, when interrupted with Voice Information, you cannot operate the buttons on the front panel or the touch buttons on the display, except for some operations.

- The operating restrictions may differ depending on which mode the unit is in during Voice Information.
- You can use the +/− or ∨/∧ (DOWN/UP) button to control the volume of Voice Information.
- Operation of the Remote Control unit (sold separately) is also restricted.

Access to iDataLink Mode

You can check the car's status, set the air conditioning, etc.

- 1 Press and hold the ★ (Favorite) button or touch [] (Vehicle Info.) in the Menu screen to activate iDataLink mode.**

- The iDataLink mode screen selected in "Setting the Default Vehicle Screen" (page 47) is displayed.

- 2 Touch the desired tag on the top of the screen.**

Select item:

Climate / Gauges / Park Sensor / Vehicle Info. / Car Setting

- The displayed tag options differ depending on the type of vehicle.

■ Climate screen example

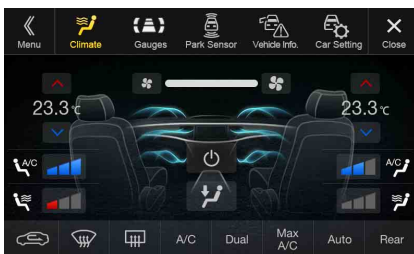

- 3 Adjust or confirm the item/information accordingly.**

- Operable functions and displays may differ depending on the vehicle.

iDataLink Function Screen example

■ Climate screen example

You can control the temperature inside the vehicle, etc.



■ Gauges screen example

You can check the vehicle's speed, the engine's rotation speed, etc.



■ Parking sensor screen example

You can check the distance from the front and rear of the vehicle to an obstacle.

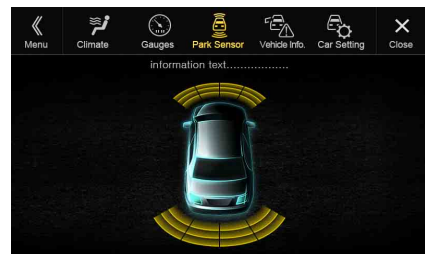

- If the car sensor detects an obstacle, the screen automatically changes to the Parking sensor screen. For details, see "About Parking Sensor screen" (page 95).

Vehicle Information screen example

You can check for open doors, check the tire pressure, the battery life, etc. for the vehicle.



Car Setting screen example (Generic List screen)

The Generic List/Popup Window/Current source control screen is displayed.

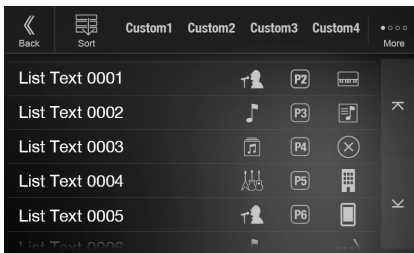

Parking Sensor Camera interlock screen example (Rear camera)

You can check for obstacles through an interlocked camera image by connecting a Front or Rear Camera.

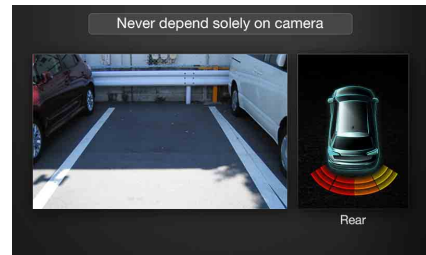

- Touch the Camera image area to switch to the Camera full screen. (While displaying the Camera full screen, touch the Camera screen, then touch [Sensor] to return to the Parking Sensor Camera interlock screen.)
- Touch the car icon to switch to the Parking sensor full screen. (Touch [⏪] on the Parking Sensor full screen to return to the Parking Sensor Camera interlock display.)
- To use this function, set the Camera Select setting to "Front/Other" or "Rear." For details, see "Setting the Camera Input" (page 45).
- If you connect a Front Camera/Rear Camera/Side Camera using the optional Multi Camera Interface module, you can switch the Camera display. For details on the camera settings when connected to the Multi Camera Interface module, see "Setting Multi Camera to On/Off" (page 47). For details on how to switch the camera display, see "Camera Operation (Optional)" (page 87).

About Parking Sensor screen

The Parking sensor screen turns on when the front or rear sensor on your vehicle detects an obstacle within a certain distance.

Parking Sensor Full screen example

When the front or rear sensor detects an obstacle within a certain distance, the Parking Sensor screen is displayed, and the indicator (① - ⑧) that corresponds with that area lights up.

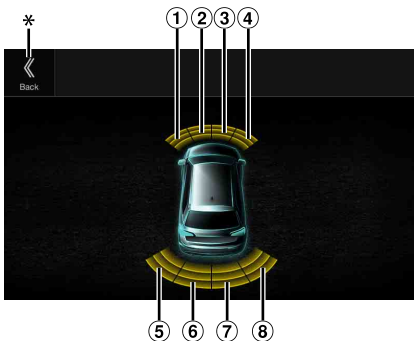

Indicator colors when an obstacle is detected.

Red: close distance
Orange: medium distance
Yellow: long distance

- Depending on the speed of the vehicle, when moving faster than a certain speed, the Parking Sensor screen may not be displayed.
- Vehicles that do not have the obstacle detection sensor cannot use this function.

* [⏪] is displayed only when the Front camera or Rear camera is interlocked.

External Accessory Control Operation

You can set the headlights to ON/OFF or adjust the air suspension from this unit by connecting the optional External Accessory Control module.

- In order to keep external accessory control outputs on during the ignition cycle, please change "Accessory During Crank" to "On". Otherwise all switches will be turned off.
[Setup] → [System] → [Factory System Setup] → [Maestro Module] → [Maestro Features] → [Maestro Module] → [Accessory During Crank] → "On"

The following explains how to edit the control switches, because the functions that can be controlled differ depending on the type of vehicle.

You cannot edit the External Accessory screen while driving.

Your vehicle must be parked with the ignition key in the ACC or ON position. For details, see "To display the Setup Menu screen" in "Setup Operation" (page 28).

1 Touch [Ext Acc Ctrl] in the Menu screen to activate External Accessory screen.

The External Accessory screen is displayed.



2 Touch [Edit] (Edit).

The Edit Control Switches screen is displayed.



3 Edit each switch.

When changing an icon:

Touch the icon, and select your desired icon from the Icon Type list. After selecting the icon, set the Output Type (Timing) for each function.

* The Output Type (Timing) sets the operating time for that function when you touch the icon on the External Accessory screen.

Pulse: The operating time when you touch the icon. (Select from 11 steps, ranging 0.5 sec. to 10 sec.)

Latch: Switch On/Off by touching the icon.

Momentary: Operating time lasts from when an icon is touched to when it is released.

When changing the name:

Touch the icon name, then input characters into Edit Name (Keypad). You can also select a basic name from the [Template] of the Keypad. For details on how to input characters using the keypad, see "How to Input Characters and Numbers (Keypad)" (page 23). (When a basic name is selected from the Template, the icon will be changed according to the basic name.)

When changing the layout of the switches:

Drag and drop an icon to the desired location.

To revert to a default icon:

Touch the check box of the icon that you want to revert to default, and then touch [Reset] (Reset). If you touch [Reset All] (Reset All), all icons revert to default icons.

4 After editing is complete, touch [Back] (Back).

5 After the caption for the confirmation is displayed, touch [OK].

- If you touch [Cancel] while editing, the edits are reset and the screen returns to the previous Edit screen.
- The first two control switches of External Accessory screen will be synchronized onto Off-Road Camera screen. For details, see "About the Off-Road Camera information" (page 92).

Information

Product Software Update

This product use software that can be updated through a USB flash drive. Download the software from the Alpine website and update the product using the USB flash drive.

Updating this product

Check the Alpine website for details on updating.

<http://www.alpine-usa.com>

Important information on the software

About the software license of the product

The software installed in the product contains open-source software. See the following Alpine website for details on the open source software.

<http://www.alpine.com/e/oss/download>

About the Supported Formats

About MP3/WMA/AAC/FLAC



CAUTION

Except for private use, duplicating audio data (including MP3/WMA/AAC/FLAC data) or distributing, transferring, or copying it, whether for free or for a fee, without permission of the copyright holder is strictly prohibited by the Copyright Act and by international treaty.

What is MP3?

MP3, whose official name is "MPEG Audio Layer 3," is a compression standard prescribed by the ISO, the International Standardisation Organisation and MPEG which is a joint activity institution of the IEC.

MP3 files contain compressed audio data. MP3 encoding is capable of compressing audio data at extremely high ratios, reducing the size of music files to as much as one-tenth their original size. This is achieved while still maintaining near CD quality. The MP3 format realizes such high compression ratios by eliminating the sounds that are either inaudible to the human ear or masked by other sounds.

What is WMA?

WMA, or "Windows Media™ Audio," is compressed audio data. WMA is similar to MP3 audio data.

What is AAC?

AAC is the abbreviation for "Advanced Audio Coding," and is a basic format of audio compression used by MPEG2 or MPEG4.

What is FLAC?

FLAC (Free Lossless Audio Codec) is an audio file codec for lossless compression, developed and offered as open source software. Codecs with lossy compression forms, such as MP3 and AAC, reduce part of the data to improve compression efficiency. However, FLAC can reconstruct compressed data to be an identical copy of the original data by performing lossless compression. The compression ratio of FLAC is about 50%.

Method for creating MP3/WMA/AAC/FLAC (USB Flash drive) files

Audio data is compressed using software with MP3/WMA/AAC/FLAC (USB Flash drive) codecs. For details on creating MP3/WMA/AAC/FLAC (USB Flash drive) files, refer to the user's manual for that software.

MP3/WMA/AAC/FLAC (USB Flash drive) files that are playable on this device have the file extensions.

MP3: "mp3"

WMA: "wma"

AAC: "m4a"

FLAC: "flac"/"fla"

WMA is not supported for the following files, Windows Media Audio Professional, Windows Media Audio 10 std or Windows Media Audio 10 Pro Lossless.

There are many different versions of the AAC format. Confirm that the software being used conforms to the acceptable formats listed above. It's possible that the format may be unplayable even though the extension is valid.

Playback of AAC files encoded by iTunes is supported.

Supported playback sampling rates and bit rates

MP3 (USB Flash drive/Disc)

Sampling rates: 48 kHz, 44.1 kHz, 32 kHz, 24 kHz, 22.05 kHz, 16 kHz, 12 kHz, 11.025 kHz, 8 kHz

Bit rates: 8 - 320 kbps

WMA (USB Flash drive/Disc)

Sampling rates: 48 kHz, 44.1 kHz, 32 kHz, 22.05 kHz, 16 kHz, 11.025 kHz, 8 kHz

Bit rates: 5 - 384 kbps

AAC (USB Flash drive/Disc)

Sampling rates: 48 kHz, 44.1 kHz, 32 kHz, 24 kHz, 22.05 kHz, 16 kHz, 12 kHz, 11.025 kHz, 8 kHz

Bit rates: 16 - 320 kbps

FLAC (USB Flash drive)

Sampling rates: 96kHz, 88.2kHz, 48kHz, 44.1kHz, 32kHz, 24kHz, 22.05kHz, 16kHz, 8kHz

Channel number: 1ch, 2ch

This device may not play back correctly depending on sampling rates.

ID3 tags/WMA tags

This device supports ID3 tag v1.0, v1.1, v2.2, v2.3, v2.4, and WMA tag Ver.1.x. If tag data is in an MP3/WMA/AAC file, this device can display the title (track title), artist name, and album name ID3 tag/WMA tag data.

For non-supported characters, "?" is displayed.

The number of characters may be limited, or not correctly displayed, depending on the tag information.

Playing back MP3/WMA/AAC/FLAC

MP3/WMA/AAC files are prepared, then written to a USB flash drive.

- Maximum numbers of playable files/folders
USB Flash drive: 10,000 files/folders (including Root Folder)
- Largest playable file size: 512 MB

Playback may not be performed if a disc exceeds the limitations described above.

If a file/folder name is long, the maximum possible number of files may decrease.

- Both Audio and Video files are counted if their formats are playable on this unit.

Media supported

The media that this device can play back a USB flash drive.

Corresponding File Systems

This device supports FAT 16/32.

The maximum nested folder depth is 8 (including the root directory). File names are limited to 256 characters (including the extension).

Valid characters for folder/file names are letters A-Z (all caps), numbers 0-9, and '_' (underscore).

Order of files

Files are played back in the order that the writing software writes them to the disc. Therefore, the playback order may not be what's expected. Verify the writing order in the software's documentation. The playback order of the folders and files is as follows. (The following numbers may differ from actually displayed numbers.)

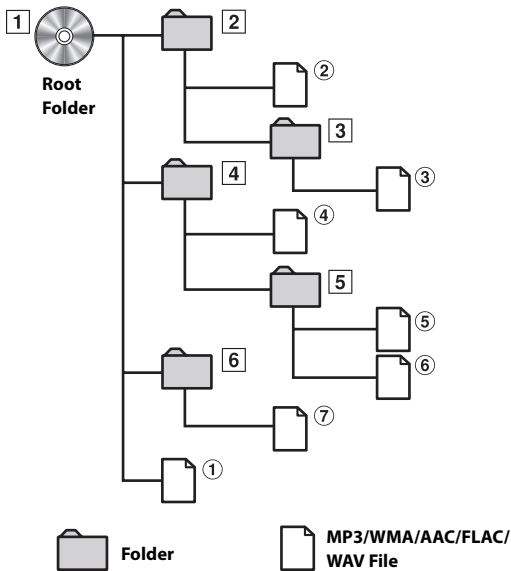

Terminology

Bit rate

This is the "sound" compression rate specified for encoding. The higher the bit rate, the higher the sound quality, but also the larger the files.

Sampling rate

This value shows how many times per second the data is sampled (recorded). For example, music CDs use a sampling rate of 44.1 kHz, so the sound is sampled (recorded) 44,100 times per second. The higher the sampling rate, the higher the sound quality, but also the larger the volume of data.

Encoding

Converting music CDs, WAVE (AIFF) files, and other sound files into the specified audio compression format.

Tag

Song information such as track titles, artist names, album names, etc., written into MP3/WMA/AAC/FLAC (USB flash drive) files.

Root folder

The root folder (or root directory) is found at the top of the file system. The root folder contains all folders and files. It is created automatically for all burned discs.

About WAV (Disc)

WAV, whose official name is "WAVE FORMAT" is a standard format of Windows® audio file.

Extension: ".wav"

Sampling rate: 44.1 kHz

Quantization bit number: 16

Channel number: up to 2ch

Format: PCM only

In Case of Difficulty

If you encounter a problem, please turn the power off, then on again. If the unit is still not functioning normally, please review the items in the following checklist. This guide will help you isolate the problem if the unit is at fault. Otherwise, make sure the rest of your system is properly connected, or then consult your authorized Alpine dealer.

Basic

No function or display.

- Vehicle's ignition is off.
 - If connected according to the instructions, the unit will not operate with the vehicle's ignition off.
- Improper power lead connections.
 - Check power lead connections.
- Blown fuse.
 - Check the fuse on the battery lead of the unit; replace with the proper value if necessary.
- Internal micro-computer malfunctioned due to interference noise, etc.
 - Press the RESET switch with a ballpoint pen or other pointed article.

No sound or unnatural sound.

- Incorrect setting of volume/balance/fader controls.
 - Readjust the controls.
- Connections are not properly or securely made.
 - Check the connections and firmly connect.

Screen not displayed.

- Brightness/Contrast control is set at the minimum position.
 - Adjust the Brightness/Contrast control.
- Temperature in the vehicle is too low.
 - Increase the vehicle's interior temperature to operation temperature range.
- Connections to the Auxiliary Device are not securely made.
 - Check the connections and firmly connect.
- The Parking Brake Lead is not connected.
- The Parking Brake is not engaged.
 - Connect the Parking Brake Lead, then engage the Parking Brake.

Movement of displayed picture is abnormal.

- Temperature in the vehicle is too high.
 - Allow the vehicle's interior temperature to cool.

The optional remote control is inoperative.

- The remote control sensor setting of "Remote Sensor Setting" (page 48) is not set to this unit ("Front").
 - Set for "Front".

Radio

Unable to receive stations.

- No antenna, or open connection in the antenna cable.
 - Make sure the antenna is properly connected; replace the antenna or cable if necessary.

Unable to tune stations in the seek mode.

- You are in a weak signal area.
 - Make sure the tuner is in DX mode.
- If the area you are in is a primary signal area, the antenna may not be grounded and connected properly.
 - Check your antenna connections; make sure the antenna is properly grounded at its mounting location.
- The antenna may not be the proper length.
 - Make sure the antenna is fully extended; if broken, replace the antenna with a new one.

Broadcast is noisy.

- The antenna is not the proper length.
 - Extend the antenna fully; replace it if it is broken.
- The antenna is poorly grounded.
 - Make sure the antenna is grounded properly at its mounting location.
- The station signal is weak and noisy.
 - If above solution does not work, tune in another station.

USB Audio

Unit does not operate.

- Condensation.
 - Wait a while (about 1 hour) for the condensation to dry.

Picture is unclear or noisy.

- Vehicle's battery power is weak.
 - Check the battery power and wiring.
(The unit may malfunction if the battery power is under 11 volts with a load applied.)

Rear Seat Entertainment System

DVD sound is not being output from the rear monitor headphones.

- The external audio processor and DVD Player (DVE-5300) are optically connected.
 - Set the Audio Out of the DVD Player to "LPCM."

Navigation

The Navigation cannot work properly.

- Reset Navigation system.
 - Turn the ignition key off, and then set to ON again.

If this Message Appears

Various messages are displayed on the screen during operation. In addition to the messages telling you the current status or providing guidance for the next operation, there are also the following error messages. If one of these error messages is displayed, carefully follow the instructions in the solution column.

System

If you are driving, please pull over and park before using this function.

- A setup operation, etc., was carried out while the vehicle was running.
 - Move the vehicle to a safe location, stop, and engage the parking brake, then carry out this operation.
-

Over-current detected on the USB.

- Abnormal current is run to the USB connector device.
 - Turn the ignition key off, and then set to ON again.
 - Attempt to connect another iPod/iPhone/USB Flash drive.
-

USB Hub is not supported.

- A USB flash drive with a hub is connected.
 - You cannot play back from a USB flash drive with a hub. USB hub connections are also not supported.
-

Audio/Visual

Connected USB Device is not compatible.

- An iPod/iPhone that is not supported by the unit is connected.
 - Connect an iPod/iPhone that is supported by the unit.
 - Reset the iPod.
 - A USB device that is not supported by the unit is connected.
 - Attempt to connect another USB flash drive.
 - Communication error.
 - Turn the ignition key off, and then set to ON again.
 - Check the display by reconnecting between the iPod/iPhone and the unit, using the iPod/iPhone cable.
 - Check the display by reconnecting between the USB flash drive and the unit.
 - Caused by the iPod/iPhone Software Version not being compatible with this unit.
 - Update the iPod/iPhone Software Version to be compatible with this unit.
 - The iPod/iPhone is not verified.
 - Change to another iPod/iPhone.
-

No data.

- There are no data in the iPod/iPhone.
 - Download data to the iPod/iPhone and connect to the unit.
 - There are no data in the USB flash drive.
 - Download data to the USB flash drive and connect to this unit.
-

Un-readable song was skipped.

- A copy-protected WMA file has been detected.
 - You can only play back non-copy-protected files.
 - A sampling rate/bit rate not supported by the unit is used.
 - Use a sampling rate/bit rate supported by the unit.
-

Bluetooth

Please connect a Bluetooth audio device.

- The Bluetooth audio device was not connected correctly.
 - Check the settings for the unit and the Bluetooth audio device and reconnect.
-

Unable to download phonebook.

- Phonebook failed to read due to mobile phone disconnection, etc.
 - Check the mobile phone connection, and then conduct synchronizing and adding again. (See page 81)
 - The connected mobile phone does not support synchronizing of its phone book.
 - Connect the mobile phone that supports synchronizing the phone book, then synchronize again. (See page 81)
-

HDMI

HDMI communication error,

Please check your device and try again.

- Communication error.
 - Turn the ignition key off, and then set to ON again.
 - Check the display by reconnecting between the HDMI and the unit, using the HDMI cable.
 - Check the display by reconnecting between the HDMI device and the unit.
-

HDMI current error,

Please reconnect your device and try again.

- Abnormal current is run to the HDMI connector device.
 - Turn the ignition key off, and then set to ON again.
 - Disconnect the HDMI device from the unit, and then reconnect it.
-

Too many monitors are connected to the HDMI output.

Please check the connection.

- More than 4 HDMI monitors are connected.
 - A cascade connection using more than 2 distributors is made.
 - Use one distributor and less than 4 HDMI monitors when connecting.
-

iDataLink

CAN Communication error

- Communication error.
 - Check the iDataLink module connection.
-

SiriusXM

Check Tuner

- The SiriusXM Tuner is disconnected or the unit is having trouble communicating with the Tuner.
 - Connect the Tuner or check the Tuner connection to the back of the unit.
-

Check Antenna

- The SiriusXM Satellite Radio antenna or cable is either damaged or not connected correctly to the SiriusXM Tuner.
 - Check that the SiriusXM antenna cable is connected to the SiriusXM Tuner and check that the antenna cable is not kinked or otherwise damaged. Replace the antenna if necessary.
 - SiriusXM products are available at your local car audio retailer or online at www.shop.siriusxm.com.
-

No Signal

- The SiriusXM satellite signal is too weak at the current location.
 - Move the vehicle to a location with a clear view of the southern sky.
 - Make sure the Satellite Radio antenna is properly mounted and not obstructed by metal objects.
-

Channel <xxx> Not Subscribed

Call SiriusXM to Subscribe

- The active channel has become unsubscribed or the requested channel is not available in your subscription package.
 - In the U.S.A., visit www.siriusxm.com or call 1-866-635-2349 if you have questions about your subscription package or would like to subscribe to this channel. In Canada, visit www.siriusxm.ca or call 1-877-438-9677.
 - The unit will revert to the previously selected channel or to channel 1 automatically.
-

Channel <xxx> Not Available

- The active channel is no longer in the SiriusXM channel lineup or the user has entered an invalid channel number.
 - Visit www.siriusxm.com for information on the current channel lineup.
 - The unit will revert to the previous channel or to channel 1 automatically.
-

Subscription Updated

Press OK to Continue

- Your subscription has been updated.
 - Touch [OK] to clear this message.
-

Channel <xxx> Locked

- A locked channel is selected.
 - Input the passcode on the number keypad screen, see “Parental Lock Function” (page 68). If wrong passcode is entered, “Incorrect Pass Code entered” will be displayed and the unit will revert to the previous channel.
-

Updating . . .

- The Featured Favorites channels are currently updating.
-

Updating Teams, please wait

- The Game table is currently updating.
-

Replay Memory Full

- Replay Buffer is full.
-

Replay Memory Near Full

- Replay Buffer will be full within 11 seconds.
-

Applying Alpine TuneIt App

You can not use Sound App

Because External AP is on.

- “Setting the External Audio Processor” (page 48) is “On.”
 - When “External Audio Processor” (page 48) is set to “On,” you cannot perform Sound Tuning from the Alpine TuneIt App. Set “External Audio Processor” to “Off” to perform Sound Tuning from the Alpine TuneIt App.
-

Navigation

The vehicle’s position is erroneous.

- The GPS reception is poor.
 - Drive the vehicle in an area of good GPS reception to allow the unit to recalibrate itself. Move to a location where strong GPS reception is possible.
-

No operation

- Moisture condensation
 - Allow enough time for the condensation to evaporate (about 1 hour).
 - Ambient Temperature
 - Make sure the temperature inside the vehicle is between 0°C and 45°C (32°F and 113°F).
-

Specifications

MONITOR SECTION

| | |
|--------------------------------------|--|
| Screen Size | 9" (X409) 8" (X308U) 7" (INE-W987HD) |
| LCD Type | Transparent type TN LCD |
| Operation System | TFT active matrix |
| Number of Picture Elements | 1,152,000 pcs. (800 × 480 × 3 (RGB)) |
| Effective Number of Picture Elements | 99% or more |
| Illumination System | LED |

FM TUNER SECTION

| | |
|-------------------------------|---------------------------|
| Tuning Range | 87.7 – 107.9 MHz |
| Mono Usable Sensitivity | 9.3 dBf (0.8 μV/75 ohms) |
| 50 dB Quieting Sensitivity | 13.5 dBf (1.3 μV/75 ohms) |
| Alternate Channel Selectivity | 80 dB |
| Signal-to-Noise Ratio | 65 dB |
| Stereo Separation | 35 dB |
| Capture Ratio | 2.0 dB |

AM TUNER SECTION

| | |
|--------------------|-----------------|
| Tuning Range | 530 – 1,710 kHz |
| Usable Sensitivity | 25.1 μV/28 dBf |

USB SECTION

| | |
|---------------------------|--------------------------|
| USB requirements | USB 2.0 |
| Max. Power Consumption | 1,500 mA (CDP Support) |
| USB Class | USB (Mass Storage Class) |
| File System | FAT16/32 |
| Number of Channels | 2-Channels (Stereo) |
| Frequency Response*1 | 5 – 20,000 Hz (±1 dB) |
| Total Harmonic Distortion | 0.008% (at 1 kHz) |
| Dynamic Range | 95 dB (at 1 kHz) |
| Signal-to-Noise Ratio | 100 dB |
| Channel Separation | 85 dB (at 1 kHz) |

*1 Frequency response may differ depending on the encoder software/bit rate.

HDMI SECTION

| | |
|---------------|----------|
| Input Format | 480p/VGA |
| Output Format | 480p |

GPS SECTION

| | |
|---------------------------|-----------------|
| GPS Reception frequency | 1,575.42 ±1 MHz |
| GPS Reception sensitivity | -136 dB max. |

Bluetooth SECTION

| | |
|-------------------------|---|
| Bluetooth Specification | Bluetooth V3.0 |
| Output Power Profile | +4 dBm Ave. (Power class 2) HFP (Hands-Free Profile) OPP (Object Push Profile) PBAP (Phone Book Access Profile) A2DP (Advanced Audio Distribution Profile) AVRCP (Audio/Video Remote Control Profile) SPP (Serial Port Profile) |

GENERAL

| | |
|--|--|
| Power Requirement | 14.4 V DC (11–16 V allowable) |
| Operating temperature | -4°F to +140°F (-20°C to +60°C) |
| Power Output | 16 W RMS × 4*2 |
| *2 Primary amplifier ratings per CEA-2006 Standard | |
| • Power output: measured at 4 Ohms and ≤ 1% THD+N | |
| • S/N: 80 dBA (reference: 1 W into 4 Ohms) | |
| Weight | 1.51 kg (3 lbs. 5 oz) (X308U) 1.41 kg (3 lbs. 2 oz) (INE-W987HD) |

Audio output level

| | |
|-----------------------|--------------------|
| Preout (Front, Rear): | 4V/10k ohms (max.) |
| Preout (Subwoofer): | 4V/10k ohms (max.) |

- Due to continuous product improvement, specifications and design are subject to change without notice.
- The LCD panel is manufactured using an extremely high precision manufacturing technology. Its effective pixel ratio is over 99.99%. This means that there is a possibility that 0.01% of the pixels could be either always ON or OFF.

NOSE/CHASSIS SIZE

X409 is sized exclusively for a certain car model.

■ X308U

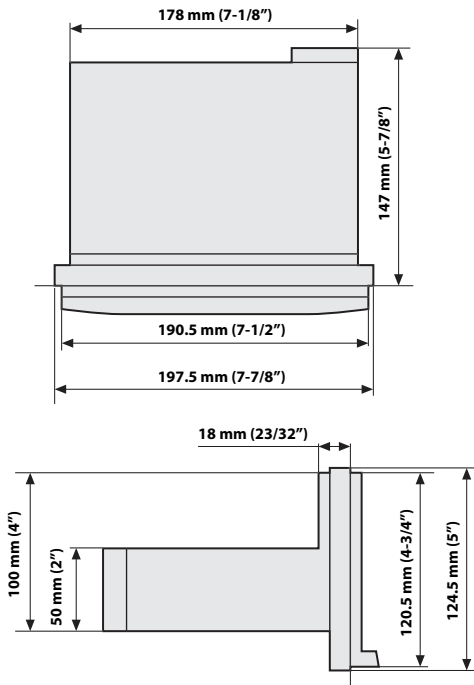

■ INE-W987HD

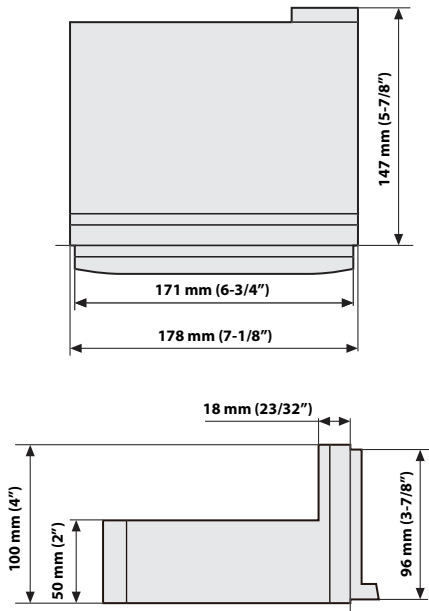

END USER LICENSE AGREEMENT (HERE)

In using this Navigation System (hereinafter referred to as "System"), which includes Alpine Electronics, Inc. ("Alpine") Specifications, Space Machine, Inc. ("Space Machine") Software and HERE North America, LLC. ("HERE") Database, you are bound by the terms and conditions set forth below. By breaking the seal on the System and using your copy of the System, you have demonstrated your agreement to the terms and conditions of this Agreement. You should, therefore, make sure that you read and understand the following provisions.

The System may not be copied, duplicated or otherwise modified, in whole or in part, without the express written permission of Alpine, Space Machine and HERE.

The System may not be transferred or sublicensed to any third party for profit, rent or loan or licensed for reuse in any manner.

The System may not be decompiled, reverse engineered or otherwise disassembled, in whole or in part.

The System may not be used in a network or by any other manner of simultaneous use in multiple systems.

The System is intended solely for personal use (or internal use where the end-user is a business) by the consumer.

The System is not to be used for commercial purposes.

Neither Alpine, Space Machine nor HERE guarantees to the customer that the System meet the specific objectives of the user.

Neither Alpine, Space Machine nor HERE shall be responsible for any damages caused by the use of the System to the actual user and to any third party.

The warranty on the System shall not extend to an exchange or refund due to misspelling, omission of letters, or any other cosmetic discrepancy in layout found in the System.

The right to use the System shall expire either when the user destroys this software, or when any of the terms for use is violated and Alpine, Space Machine and/or HERE exercise the option to revoke the license to use this software.

The terms and conditions hereof apply to all subsequent users and owner's as well as to the original purchaser.

The HERE Database may include or reflect data of licensors, including Her Majesty The Queen in right of CANADA. Such data is licensed on an "AS IS" basis. The licensors, including Her Majesty The Queen, make no guarantees, representations or warranties respecting such data, either express or implied, arising by law or otherwise, accuracy or fitness for a particular purpose.

The licensors, including Her Majesty The Queen, shall not be liable in respect of any claim, demand or action, irrespective of the nature of the cause of the claim, demand or action alleging any loss, injury or damages, direct or indirect, which may result from the use or possession of the data or the HERE database. The licensors, including Her Majesty The Queen, shall not be liable in any way for loss of revenues or contracts, or any other consequential loss of any kind resulting from any defect in the data or the HERE database.

End User shall indemnify and save harmless the licensors, including Her Majesty The Queen and the minister, and their officers, employees and agents from and against any claim, demand or action, irrespective of the nature of the cause of the claim, demand or action, alleging loss, costs, expenses, damages or injuries (including injuries resulting in death) arising out of the use or possession of the data or the HERE database.



LIMITED WARRANTY

ALPINE ELECTRONICS OF AMERICA, INC. ("Alpine"), is dedicated to quality craftsmanship and is pleased to offer this Warranty. We suggest that you read it thoroughly. Should you have any questions, please contact your Dealer or contact Alpine at one of the telephone numbers listed below.

● PRODUCTS COVERED:

This Warranty covers Car Audio Products and Related Accessories ("the product"). Products purchased in the Canada are covered only in the Canada. Products purchased in the U.S.A. are covered only in the U.S.A.

● LENGTH OF WARRANTY:

This Warranty is in effect for one year from the date of the first consumer purchase.

● WHO IS COVERED:

This Warranty only covers the original purchaser of the product, who must reside in the United States, Puerto Rico or Canada.

● WHAT IS COVERED:

This Warranty covers defects in materials or workmanship (parts and labor) in the product.

● WHAT IS NOT COVERED:

This Warranty does not cover the following:

- ① Damage occurring during shipment of the product to Alpine for repair (claims must be presented to the carrier).
- ② Damage caused by accident or abuse, including burned voice coils caused by over-driving the speaker (amplifier level is turned up and driven into distortion or clipping). Speaker mechanical failure (e.g. punctures, tears or rips). Cracked or damaged LCD panels. Dropped or damaged hard drives.
- ③ Damage caused by negligence, misuse, improper operation or failure to follow instructions contained in the Owner's manual.
- ④ Damage caused by act of God, including without limitation, earthquake, fire, flood, storms or other acts of nature. Any cost or expense related to the removal or reinstallation of the product.
- ⑤ Service performed by an unauthorized person, company or association.
- ⑥ Any product which has the serial number defaced, altered or removed.
- ⑦ Any product which has been adjusted, altered or modified without Alpine's consent.
- ⑧ Any product not distributed by Alpine within the United States, Puerto Rico or Canada.
- ⑨ Any product not purchased from an Authorized Alpine Dealer.

● HOW TO OBTAIN WARRANTY SERVICE:

- ① You are responsible for delivery of the product to an Authorized Alpine Service Center or Alpine for repair and for payment of any initial shipping charges. Alpine will, at its option, repair or replace the product with a new or reconditioned product without charge. If the repairs are covered by the warranty, and if the product was shipped to an Authorized Alpine Service Center or Alpine, Alpine will pay the return shipping charges.
- ② You should provide a detailed description of the problem(s) for which service is required.

- ③ You must supply proof of your purchase of the product.
- ④ You must package the product securely to avoid damage during shipment. To prevent lost packages it is recommended to use a carrier that provides a tracking service.

● HOW WE LIMIT IMPLIED WARRANTIES:

ANY IMPLIED WARRANTIES INCLUDING FITNESS FOR USE AND MERCHANTABILITY ARE LIMITED IN DURATION TO THE PERIOD OF THE EXPRESS WARRANTY SET FORTH ABOVE AND NO PERSON IS AUTHORIZED TO ASSUME FOR ALPINE ANY OTHER LIABILITY IN CONNECTION WITH THE SALE OF THE PRODUCT.

● HOW WE EXCLUDE CERTAIN DAMAGES:

ALPINE EXPRESSLY DISCLAIMS LIABILITY FOR INCIDENTAL AND CONSEQUENTIAL DAMAGES CAUSED BY THE PRODUCT. THE TERM "INCIDENTAL DAMAGES" REFERS TO EXPENSES OF TRANSPORTING THE PRODUCT TO THE ALPINE SERVICE CENTER, LOSS OF THE ORIGINAL PURCHASER'S TIME, LOSS OF THE USE OF THE PRODUCT, BUS FARES, CAR RENTALS OR OTHERS COSTS RELATING TO THE CARE AND CUSTODY OF THE PRODUCT. THE TERM "CONSEQUENTIAL DAMAGES" REFERS TO THE COST OF REPAIRING OR REPLACING OTHER PROPERTY WHICH IS DAMAGED WHEN THIS PRODUCT DOES NOT WORK PROPERLY. THE REMEDIES PROVIDED UNDER THIS WARRANTY ARE EXCLUSIVE AND IN LIEU OF ALL OTHERS.

● HOW STATE/PROVINCIAL LAW RELATES TO THE WARRANTY:

This Warranty gives you specific legal rights, and you may also have other rights which vary from state to state and province to province. In addition, some states/provinces do not allow limitations on how long an implied warranty lasts, and some do not allow the exclusion or limitation of incidental or consequential damages. Accordingly, limitations as to these matters contained herein may not apply to you.

● IN CANADA ONLY:

This Warranty is not valid unless your Alpine car audio product has been installed in your vehicle by an Authorized Installation Center, and this warranty stamped upon installation by the installation center.

● HOW TO CONTACT CUSTOMER SERVICE:

Should the product require service, please call the following number for your nearest Authorized Alpine Service Center.

| | |
|------------|---------------------------------|
| CAR AUDIO | 1-800-ALPINE-1 (1-800-257-4631) |
| NAVIGATION | 1-888-NAV-HELP (1-888-628-4357) |

Or visit our website at: <http://www.alpine-usa.com>

ALPINE ELECTRONICS OF AMERICA, INC., 19145 Gramercy Place, Torrance, California 90501, U.S.A.

Do not send products to this address.

Call the toll free telephone number or visit the website to locate a service center.

About the Rules of Bluetooth Electromagnetic Radiation Regulation

| | |
|-------------------|--|
| USA/Canada | <p>FCC/IC CAUTION</p> <p>This device complies with Industry Canada's licence-exempt RSSs. Operation is subject to the following two conditions:</p> <p>(1) This device may not cause interference; and</p> <p>(2) This device must accept any interference, including interference that may cause undesired operation of the device.</p> <p>Changes or modifications not expressly approved by the party responsible for compliance could void the user's authority to operate the equipment.</p> <p>This equipment complies with FCC/IC radiation exposure limits set forth for an uncontrolled environment and meets the FCC radio frequency (RF) Exposure Guidelines and RSS-102 of the IC radio frequency (RF) Exposure rules. This equipment has very low levels of RF energy that it deemed to comply without maximum permissive exposure evaluation (MPE). But it is desirable that it should be installed and operated keeping the radiator at least 20 cm or more away from person's body.</p> |
| | <p>Le présent appareil est conforme aux CNR d'Industrie Canada applicables aux appareils radio exempts de licence. L'exploitation est autorisée aux deux conditions suivantes :</p> <p>(1) l'appareil ne doit pas produire de brouillage;</p> <p>(2) l'utilisateur de l'appareil doit accepter tout brouillage radioélectrique subi, même si le brouillage est susceptible d'en compromettre le fonctionnement.</p> <p>Cet équipement est conforme aux limites d'exposition aux rayonnements énoncées pour un environnement non contrôlé et respecte les règles les radioélectriques (RF) de la FCC lignes directrices d'exposition et d'exposition aux fréquences radioélectriques (RF) CNR-102 de l'IC. Cet équipement émet une énergie RF très faible qui est considérée conforme sans évaluation de l'exposition maximale autorisée (MPE). Cependant, il est souhaitable qu'il devrait être installé et utilisé en gardant une distance de 20 cm ou plus entre le radiateur et le corps humain.</p> |

Don't forget to take a moment to protect your purchase by registering your product now at the following address: www.alpine-usa.com/registration.

N'oubliez pas de consacrer un moment à la protection de votre achat en enregistrant votre produit dès maintenant à l'adresse suivante : www.alpine-usa.com/registration.

Recuerde que con solo unos pocos pasos podrá proteger su producto, registrándolo a través de la siguiente dirección: www.alpine-usa.com/registration.